

User's Guide

NAP Series

NAP102 / NAP203 / NAP303 / NAP353

802.11ac Dual-Radio Nebula Cloud Managed Access Point

Default Login Details

Web Address	http://(DHCP-assigned IP) or http://192.168.1.2
User Name	admin
Password	Assigned by NCC or 1234

Version 1.00 Edition 1, 02/2017

Note: Login is required only when VLAN or IP address has to be changed.

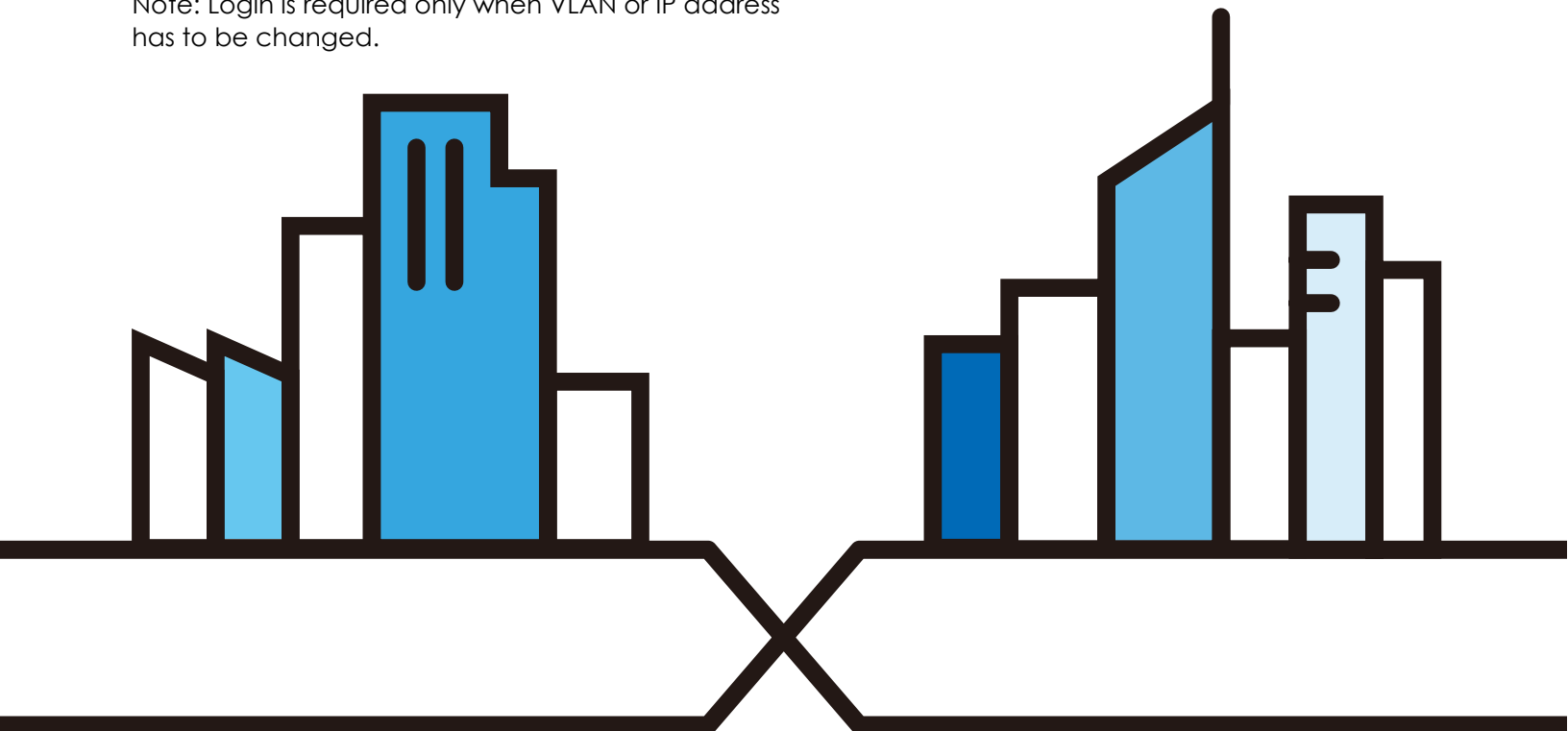

IMPORTANT!

READ CAREFULLY BEFORE USE.

KEEP THIS GUIDE FOR FUTURE REFERENCE.

This is a User's Guide for a series of products. Not all products support all firmware features. Screenshots and graphics in this book may differ slightly from your product due to differences in your product firmware or your computer operating system. Every effort has been made to ensure that the information in this manual is accurate.

Related Documentation

- Quick Start Guide

The Quick Start Guide shows how to connect the NAP and access the Web Configurator.

- Web Configurator Online Help

Click the help icon in any screen for help in configuring that screen and supplementary information.

- More Information

Go to support.zyxel.com to find other information on the NAP.



Contents Overview

Introduction	6
The Web Configurator	14
Dashboard	18
Network	20
Troubleshooting	24

Table of Contents

Contents Overview	3
Table of Contents	4
Chapter 1	
Introduction	6
1.1 Overview	6
1.1.1 Dual-Radio	6
1.2 Ways to Manage the NAP	7
1.3 Good Habits for Managing the NAP	7
1.4 Hardware Connections	8
1.5 LEDs	8
1.5.1 NAP303	8
1.5.2 NAP203	10
1.5.3 NAP102	11
Chapter 2	
The Web Configurator.....	14
2.1 Overview	14
2.2 Access	14
2.3 Navigating the Web Configurator	15
2.3.1 Title Bar	15
2.3.2 Navigation Panel	16
2.3.3 Warning Messages	17
Chapter 3	
Dashboard.....	18
3.1 Overview	18
3.1.1 What You Can Do in this Chapter	18
3.2 Dashboard	18
Chapter 4	
Network.....	20
4.1 Overview	20
4.1.1 What You Can Do in this Chapter	20
4.2 IP Setting	20
4.3 VLAN	21
Chapter 5	
Troubleshooting.....	24

5.1 Overview	24
5.2 Power, Hardware Connections, and LED	24
5.3 NAP Access and Login	25
5.4 Internet Access	26
5.5 Wireless Connections	27
5.6 Resetting the NAP	29
5.7 Getting More Troubleshooting Help	29
Appendix A Customer Support	30
Appendix B Legal Information	36
Index	47

CHAPTER 1

Introduction

1.1 Overview

This User's Guide covers the following models: NAP102, NAP203, NAP303 and NAP353. Your NAP is a wireless AP (Access Point). It extends the range of your existing wired network without additional wiring, providing easy network access to mobile users.

The NAP is managed and provisioned by the NCC (Nebula Control Center) automatically when it is connected to the Internet. If you need to change the NAP's VLAN setting or manually set its IP address, access its built-in web-based configuration tool. You can check the NCC's **AP > Monitor > Access Point** screen or the connected gateway for the NAP's current LAN IP address. Alternatively, disconnect the gateway or disable its DHCP server function and use the NAP's default static LAN IP address (192.168.1.2).

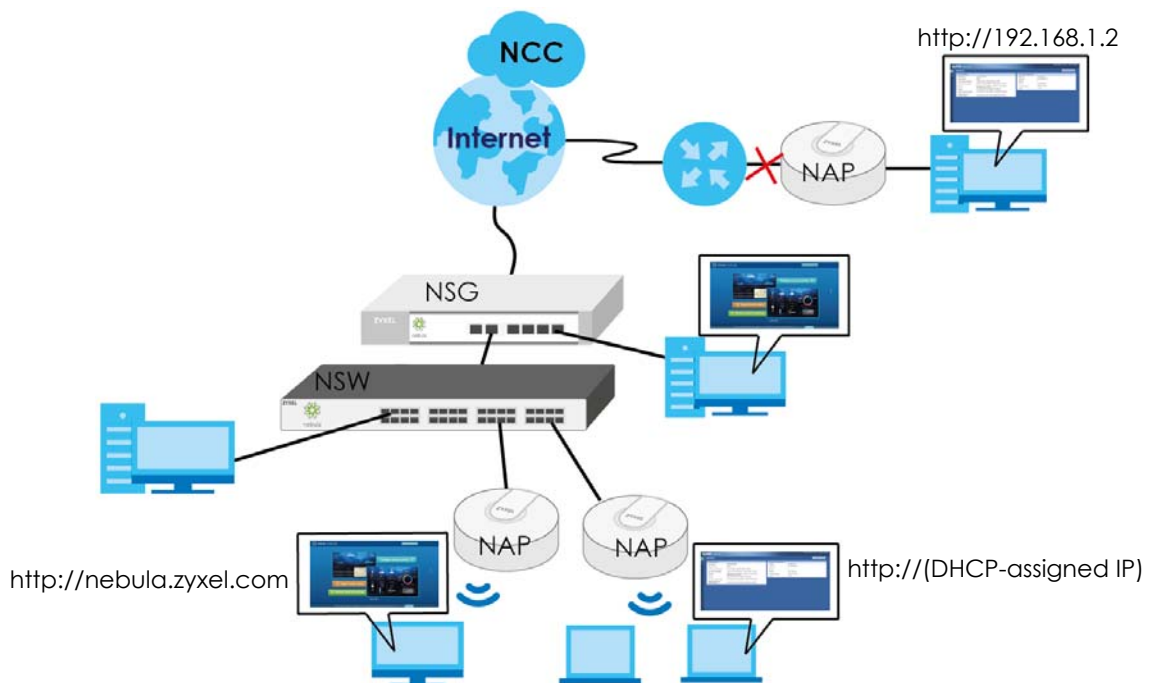

1.1.1 Dual-Radio

The NAP is equipped with dual wireless radios. This means you can configure two different wireless networks to operate simultaneously.

Note: A different channel should be configured for each WLAN interface to reduce the effects of radio interference.

You could use the 2.4 GHz band for regular Internet surfing and downloading while using the 5 GHz band for time sensitive traffic like high-definition video, music, and gaming.

Figure 1 Dual-Radio Application

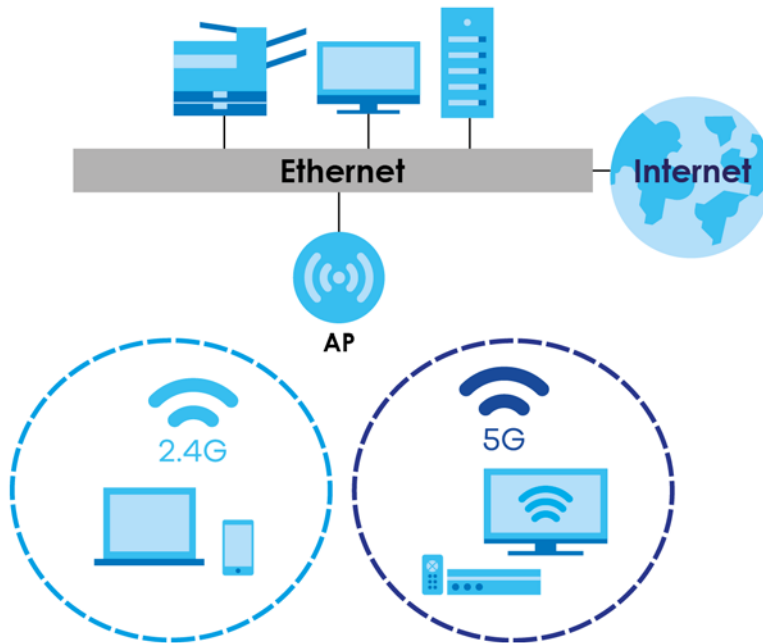

1.2 Ways to Manage the NAP

You can use the following ways to manage the NAP.

Web Configurator

The Web Configurator allows basic NAP setup and monitoring using an Internet browser. This User's Guide provides information about the Web Configurator.

NCC (Nebula Control Center)

With the NCC, you can remotely manage and monitor the NAP through a cloud-based network management system. See the NCC User's Guide for more information.

1.3 Good Habits for Managing the NAP

Do the following things regularly to make the NAP more secure and to manage it more effectively.

- Change the system password through the NCC often. Use a password that's not easy to guess and that consists of different types of characters, such as numbers and letters.
- Write down the password and put it in a safe place.

1.4 Hardware Connections

See your Quick Start Guide for information on making hardware connections.

1.5 LEDs

The LEDs of your NAP303 or NAP203 can be controlled by using the Suppression feature such that the LEDs stay lit (ON) or OFF after the device is ready.

Following are LED descriptions for the NAP series models.

1.5.1 NAP303







The LEDs will stay ON when the NAP303 is ready. You can change this setting through the NCC (Nebula Control Center).

Figure 2 NAP303 LEDs



The following table describes the LEDs.

Table 1 NAP303 LEDs

LED	COLOR	STATUS	DESCRIPTION
PWR/SYS 	Red	Slow Blinking (On for 1s, Off for 1s)	The NAP is booting up.
	Green	On	
	Red	Off	The NAP is ready for use.
	Green	On	
	Red	On	There is system error and the NAP cannot boot up, or the NAP suffered a system failure.
	Green	Off	
	Red	Fast Blinking (on for 50ms, Off for 50ms)	The NAP is undergoing firmware upgrade.
	Green	Off	
	Red	Slow Blinking (blink for 3 times, Off for 3s)	The Uplink port is disconnected.
	Green	Off	
	Red	Slow Blinking (blink for 2 times, Off for 3s)	The wireless module of the NAP is disabled or failed.
Green	Off		
Management 	Green	On	The NAP is managed by the NCC.
		Slow Blinking (On for 1s, Off for 1s)	The NAP is connected to the NCC, but not registered.
	Amber	Slow Blinking (blink for 3 times, Off for 3s)	The NAP is searching for (discovering) the NCC.
WLAN 	Green	On	The 2.4 GHz WLAN is active.
		Off	The 2.4 GHz WLAN is not active.
WLAN 	Green	On	The 5 GHz WLAN is active.
		Off	The 5 GHz WLAN is not active.
UPLINK 	Amber/ Green	On	Amber - The port is operating as a 100-Mbps connection. Green - The port is operating as a Gigabit connection (1000 Mbps).
		Blinking	The NAP is sending/receiving data through the port.
		Off	The port is not connected.
LAN 	Amber/ Green	On	Amber - The port is operating as a 100-Mbps connection. Green - The port is operating as a Gigabit connection (1000 Mbps).
		Blinking	The LAN port is sending/receiving data through the port.
		Off	The LAN port is not connected.
Locator 	White	Blinking	The Locator is activated and will show the actual location of the NAP between several devices in the network.
		Off	The Locator function is off.

1.5.2 NAP203

The LEDs will stay ON when the NAP203 is ready. You can change this setting through the NCC (Nebula Control Center).

Figure 3 NAP203 LEDs

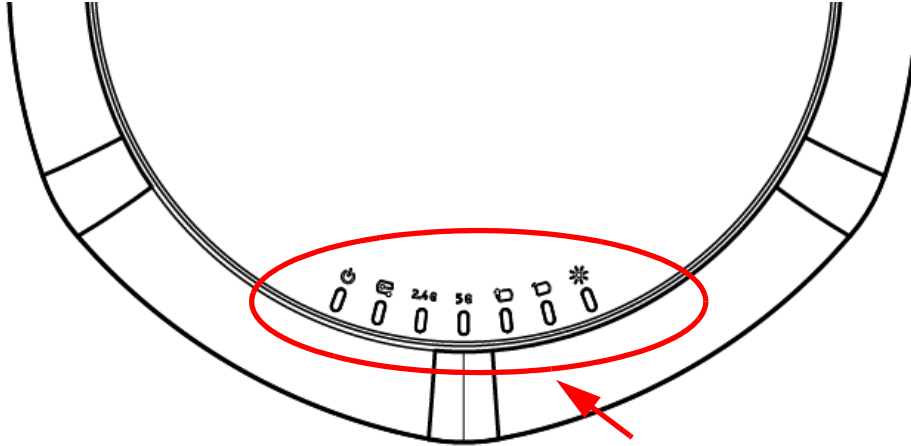

The following table describes the LEDs.

Table 2 NAP203 LEDs





LED	COLOR	STATUS	DESCRIPTION
PWR/SYS 	Red	Slow Blinking (On for 1s, Off for 1s)	The NAP is booting up.
	Green	On	
	Red	Off	The NAP is ready for use.
	Green	On	
	Red	On	There is system error and the NAP cannot boot up, or the NAP suffered a system failure.
	Green	Off	
	Red	Fast Blinking (on for 50ms, Off for 50ms)	The NAP is undergoing firmware upgrade.
	Green	Off	
	Red	Slow Blinking (blink for 3 times, Off for 3s)	The Uplink port is disconnected.
	Green	Off	
	Red	Slow Blinking (blink for 2 times, Off for 3s)	The wireless module of the NAP is disabled or failed.
Green	Off		
Management 	Green	On	The NAP is managed by the NCC.
		Slow Blinking (On for 1s, Off for 1s)	The NAP is connected to the NCC, but not registered.
	Amber	Slow Blinking (blink for 3 times, Off for 3s)	The NAP is searching for (discovering) the NCC.

Table 2 NAP203 LEDs (continued)

LED	COLOR	STATUS	DESCRIPTION
WLAN 2.4G	Green	On	The antenna switch is set to "Ceiling" for the radio. The 2.4 GHz WLAN is active.
	Amber	On	The antenna switch is set to "Wall" for the radio. The 2.4 GHz WLAN is active.
		Off	The 2.4 GHz WLAN is not active.
WLAN 5G	Green	On	The antenna switch is set to "Ceiling" for the radio. The 5 GHz WLAN is active.
	Amber	On	The antenna switch is set to "Wall" for the radio. The 5 GHz WLAN is active.
		Off	The 5 GHz WLAN is not active.
UPLINK 	Amber/ Green	On	Amber - The port is operating as a 100-Mbps connection. Green - The port is operating as a Gigabit connection (1000 Mbps).
		Blinking	The NAP is sending/receiving data through the port.
		Off	The port is not connected.
LAN 	Amber/ Green	On	Amber - The port is operating as a 100-Mbps connection. Green - The port is operating as a Gigabit connection (1000 Mbps).
		Blinking	The LAN port is sending/receiving data through the port.
		Off	The LAN port is not connected.
Locator 	White	Blinking	The Locator is activated and will show the actual location of the NAP between several devices in the network.
		Off	The Locator function is off.

1.5.3 NAP102

The following are the LED descriptions for your NAP102.

Figure 4 NAP102 LED



The following are the LED descriptions for your NAP102.

Table 3 NAP102 LED

COLOR	STATUS	DESCRIPTION
Red	Slow Blinking (On for 1s, Off for 1s)	The NAP is booting up.
Green	On	
Red	Off	The NAP is ready for use.
Green	On	
Red	Off	The NAP's wireless interface is activated.
Green	On	
Red	Slow Blinking (blink for 3 times, Off for 3s)	The NAP is searching for (discovering) the NCC.
Green	On	
Red	Off	The NAP is connected to the NCC, but not registered.
Green	Slow Blinking (On for 1s, Off for 1s)	
Red	On	The NAP failed to boot up or is experience system failure.
Green	Off	
Red	Fast Blinking (On for 50ms, Off for 50ms)	The NAP is undergoing firmware upgrade.
Green	Off	
Red	Slow Blinking (blink for 3 times, Off for 3s)	The Uplink port is disconnected.
Green	Off	

Table 3 NAP102 LED (continued)

COLOR	STATUS	DESCRIPTION
Amber	Slow Blinking (blink for 2 times, Off for 3s)	The wireless LAN is disabled or fails.
Green	Off	

CHAPTER 2

The Web Configurator

2.1 Overview

The NAP Web Configurator allows easy management using an Internet browser.

In order to use the Web Configurator, you must:

- Use Internet Explorer 10.0 and later versions, Mozilla Firefox 36.0 and later versions, Safari 9.0 and later versions, or Google Chrome 38.0 and later versions.
- Allow pop-up windows.
- Enable JavaScript (enabled by default).
- Enable Java permissions (enabled by default).
- Enable cookies.

The recommended screen resolution is 1024 x 768 pixels and higher.

2.2 Access

- 1 Make sure your NAP (Nebula AP) hardware is properly connected. See the Quick Start Guide.
- 2 Make sure your computer's IP address is in the same subnet as the NAP's IP address.
- 3 Browse to [http://\(NAP's IP address\)](http://(NAP's IP address)). See [Section 1.1 on page 6](#) for more information.
- 4 The **Login** screen appears.



Enter User Name/Password and click to login.

User Name:

Password:

(max. 63 alphanumeric, printable characters and no spaces)

Login Reset

- 5 Enter the user name (default: "admin") and password (default: "1234"). If the NAP is being managed or has been managed by the NCC, check the NCC's **Site-Wide > Configure > General setting** screen for the NAP's current password.
- 6 Click **Login**.

2.3 Navigating the Web Configurator

The following summarizes how to navigate the web configurator from the **Dashboard** screen. This guide uses the NAP102 screens as an example. The screens may vary slightly for different models.

Figure 5 The Web Configurator's Main Screen

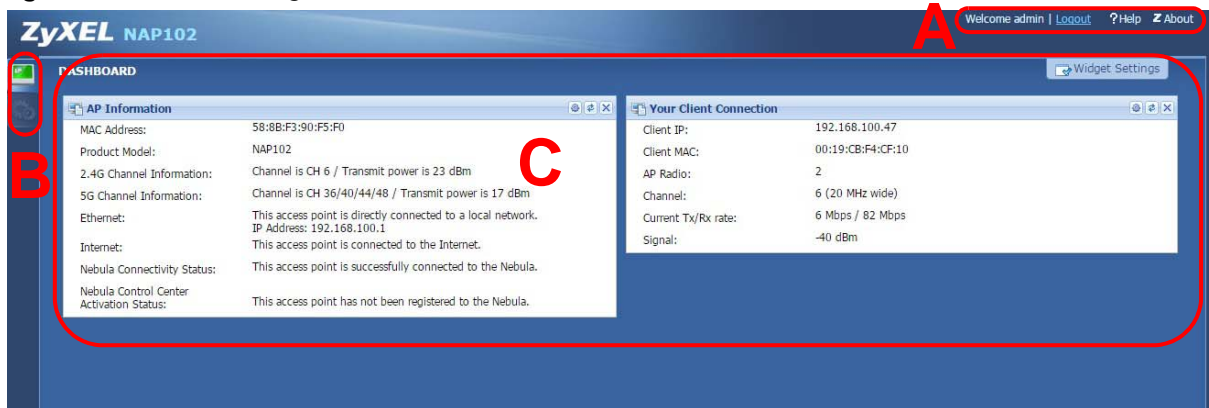

The Web Configurator's main screen is divided into these parts:

- **A** - Title Bar
- **B** - Navigation Panel
- **C** - Main Window

2.3.1 Title Bar

The title bar provides some useful links that always appear over the screens below, regardless of how deep into the Web Configurator you navigate.

Figure 6 Title Bar



The icons provide the following functions.

Table 4 Title Bar: Web Configurator Icons

LABEL	DESCRIPTION
Logout	Click this to log out of the Web Configurator.
Help	Click this to open the help page for the current screen.
About	Click this to display basic information about the NAP.

About

Click **About** to display basic information about the NAP.

Figure 7 About

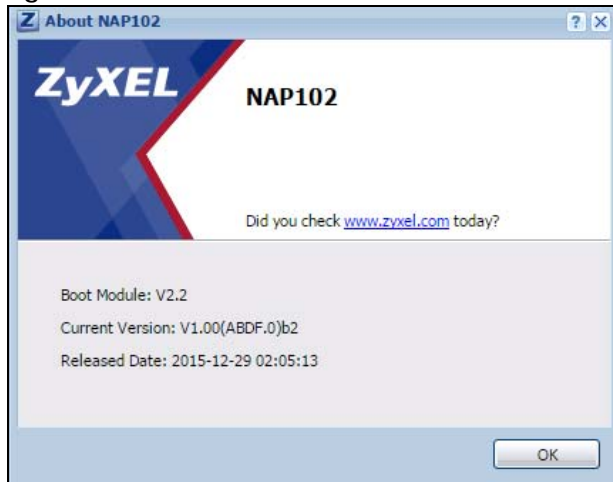

The following table describes labels that can appear in this screen.

Table 5 About

LABEL	DESCRIPTION
Boot Module	This shows the version number of the software that handles the booting process of the NAP.
Current Version	This shows the firmware version of the NAP.
Released Date	This shows the date (yyyy-mm-dd) and time (hh:mm:ss) when the firmware is released.
OK	Click this to close the screen.

2.3.2 Navigation Panel

Use the menu items on the navigation panel to open screens to configure NAP features. Click the arrow in the middle of the right edge of the navigation panel to hide the navigation panel menus or drag it to resize them. The following sections introduce the NAP's navigation panel menus and their screens.

Figure 8 Navigation Panel

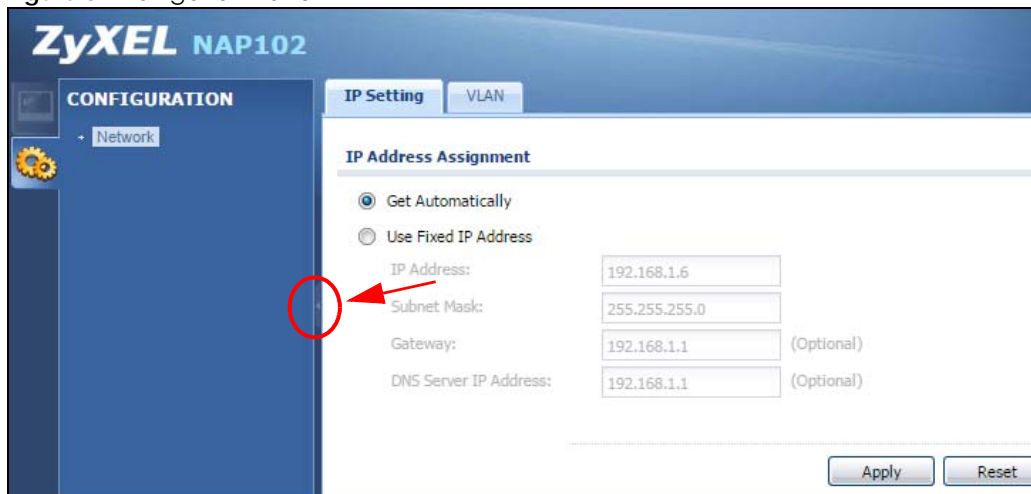

Dashboard

The dashboard displays general device information, and AP information in widgets that you can re-arrange to suit your needs.

For details on the Dashboard's features, see [Chapter 3 on page 18](#).

Configuration Menu

Use the configuration menu screens to configure the NAP's features.

Table 6 Configuration Menu Screens Summary

FOLDER OR LINK	TAB	FUNCTION
Network	IP Setting	Configure the IP address for the NAP Ethernet interface.
	VLAN	Manage the Ethernet interface VLAN settings.

2.3.3 Warning Messages

Warning messages, such as those resulting from misconfiguration, display in a pop up window.

Figure 9 Warning Message

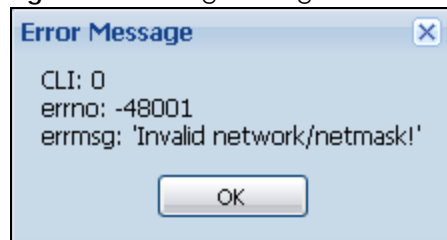

CHAPTER 3

Dashboard

3.1 Overview

Use the **Dashboard** screens to check status information about the NAP.

3.1.1 What You Can Do in this Chapter

- The main **Dashboard** screen ([Section 3.2 on page 18](#)) displays the NAP's general device information, and client information.

3.2 Dashboard

This screen is the first thing you see when you log into the NAP. It also appears every time you click the **Dashboard** icon in the navigation panel. The Dashboard displays general AP information, and client information in widgets that you can re-arrange to suit your needs. You can also collapse, refresh, and close individual widgets.

Figure 10 Dashboard

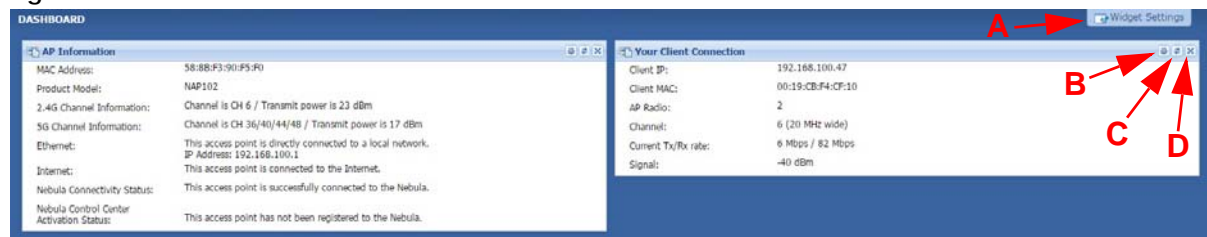

The following table describes the labels in this screen.

Table 7 Dashboard

LABEL	DESCRIPTION
Widget Settings (A)	Use this link to re-open closed widgets.
Refresh Time Setting (B)	Set the interval for refreshing the information displayed in the widget.
Refresh Now (C)	Click this to update the widget's information immediately.
Close Widget (D)	Click this to close the widget. Use Widget Settings to re-open it.
AP Information	
MAC Address	This field displays the MAC address of the NAP.
Product Model	This field displays the model name of the NAP.
2.4G Channel Information	This field displays the channel number the NAP is using and its output power in the 2.4 GHz spectrum.

Table 7 Dashboard (continued)

LABEL	DESCRIPTION
5G Channel Information	This field displays the channel number the NAP is using and its output power in the 5 GHz spectrum.
Ethernet	This field displays whether the NAP's Ethernet port is connected and the IP address of the gateway to which the NAP is connected.
Internet	This field displays whether the NAP is connecting to the Internet.
Nebula Connectivity Status	This field displays whether the NAP can connect to the Zyxel Nebula Control Center (NCC).
Nebula Control Center Activation Status	This field displays whether the NAP has been registered and can be managed by the NCC.
Your Client Connection	
Client IP	This field displays the IP address of the wireless client from which you access the NAP's web configurator.
Client MAC	This field displays the MAC address of the wireless client from which you access the NAP's web configurator.
AP Radio	This field displays the number of spatial streams for the NAP.
Channel	This field displays the channel number and channel bandwidth used by the connected wireless client.
Current Tx/Rx rate	This field displays the current transmission rate and reception rate of the connected wireless client.
Signal	This field displays the signal strength of the connected wireless client.

CHAPTER 4

Network

4.1 Overview

This chapter describes how you can configure the management IP address and VLAN settings of your NAP.

The Internet Protocol (IP) address identifies a device on a network. Every networking device (including computers, servers, routers, printers, etc.) needs an IP address to communicate across the network. These networking devices are also known as hosts.

Figure 11 IP Setup

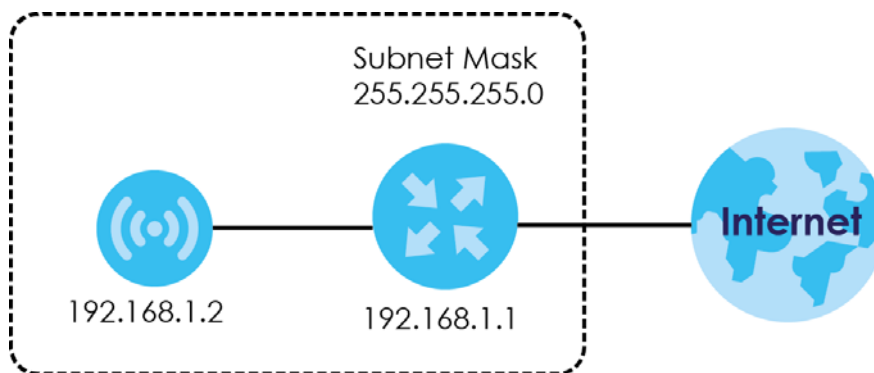

The figure above illustrates one possible setup of your NAP. The gateway IP address is 192.168.1.1 and the managed IP address of the NAP is 192.168.1.2 (default), but if the NAP is assigned an IP address by a DHCP server, the default (192.168.1.2) will not be used. The gateway and the NAP must belong in the same IP subnet to be able to communicate with each other.

4.1.1 What You Can Do in this Chapter

- The **IP Setting** screen ([Section 4.2 on page 20](#)) configures the NAP's LAN IP address.
- The **VLAN** screen ([Section 4.3 on page 21](#)) configures the NAP's VLAN settings.

4.2 IP Setting

Use this screen to configure the IP address for your NAP. To access this screen, click **Configuration > Network > IP Setting**.

Figure 12 Configuration > Network > IP Setting

Each field is described in the following table.

Table 8 IP Setting

LABEL	DESCRIPTION
IP Address Assignment	
Get Automatically	Select this to make the interface a DHCP client and automatically get the IP address, subnet mask, and gateway address from a DHCP server.
Use Fixed IP Address	Select this if you want to specify the IP address, subnet mask, and gateway manually.
IP Address	Enter the IP address for this interface.
Subnet Mask	Enter the subnet mask of this interface in dot decimal notation. The subnet mask indicates what part of the IP address is the same for all computers in the network.
Gateway	Enter the IP address of the gateway. The NAP sends packets to the gateway when it does not know how to route the packet to its destination. The gateway should be on the same network as the interface.
DNS Server IP Address	Enter the IP address of the DNS server.
Apply	Click Apply to save your changes back to the NAP.
Reset	Click Reset to return the screen to its last-saved settings.

4.3 VLAN

This section discusses how to configure the NAP's VLAN settings.

Figure 13 Management VLAN Setup

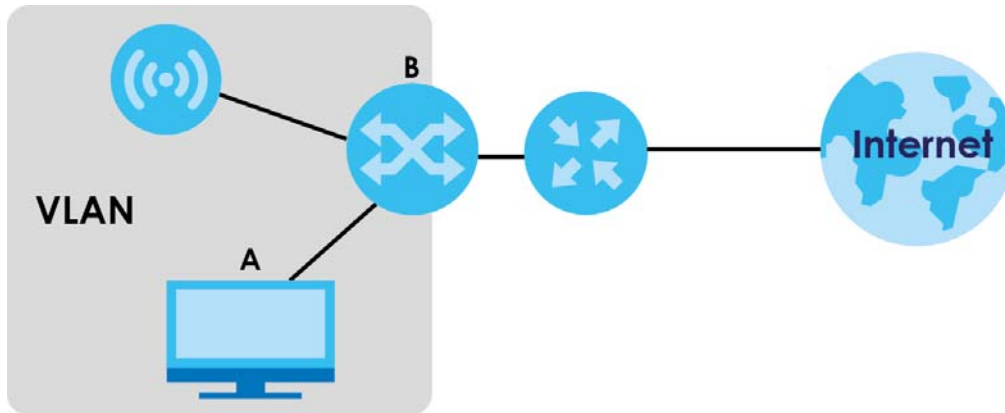

In the figure above, to access and manage the NAP from computer **A**, the NAP and switch **B**'s ports to which computer **A** and the NAP are connected should be in the same VLAN.

A Virtual Local Area Network (VLAN) allows a physical network to be partitioned into multiple logical networks. Devices on a logical network belong to one group. A device can belong to more than one group. With VLAN, a device cannot directly talk to or hear from devices that are not in the same group(s); the traffic must first go through a router.

VLAN also increases network performance by limiting broadcasts to a smaller and more manageable logical broadcast domain. In traditional switched environments, all broadcast packets go to each and every individual port. With VLAN, all broadcasts are confined to a specific broadcast domain.

IEEE 802.1Q Tag

The IEEE 802.1Q standard defines an explicit VLAN tag in the MAC header to identify the VLAN membership of a frame across bridges. A VLAN tag includes the 12-bit VLAN ID and 3-bit user priority. The VLAN ID associates a frame with a specific VLAN and provides the information that devices need to process the frame across the network.

Use this screen to configure the VLAN settings for your NAP. To access this screen, click **Configuration > Network > VLAN**.

Figure 14 Configuration > Network > VLAN

The screenshot shows a web-based configuration interface for VLAN settings. At the top, there are two tabs: 'IP Setting' and 'VLAN', with 'VLAN' being the active tab. Below the tabs, the title 'VLAN Settings' is displayed. The main configuration area contains a 'Management VLAN ID' field with the value '1' and a range '(1~4094)'. Below this field, there are two radio buttons: 'Untagged' (which is selected) and 'Tagged'. At the bottom of the form, there are two buttons: 'Apply' and 'Reset'.

Each field is described in the following table.

Table 9 VLAN

LABEL	DESCRIPTION
VLAN Settings	
Management VLAN ID	Enter a VLAN ID for the NAP.
Untagged/ Tagged	Set whether the NAP adds the VLAN ID to outbound traffic transmitted through its Ethernet port.
Apply	Click Apply to save your changes back to the NAP.
Reset	Click Reset to return the screen to its last-saved settings.

CHAPTER 5

Troubleshooting

5.1 Overview

This chapter offers some suggestions to solve problems you might encounter. The potential problems are divided into the following categories.

- [Power, Hardware Connections, and LED](#)
- [NAP Access and Login](#)
- [Internet Access](#)
- [Wireless Connections](#)
- [Resetting the NAP](#)

5.2 Power, Hardware Connections, and LED

[The NAP does not turn on. The LED is not on.](#)

- 1 Make sure you are using the power adaptor included with the NAP or a PoE power injector/switch.
- 2 Make sure the power adaptor or PoE power injector/switch is connected to the NAP and plugged in to an appropriate power source. Make sure the power source is turned on.
- 3 Disconnect and re-connect the power adaptor or PoE power injector/switch.
- 4 Inspect your cables for damage. Contact the vendor to replace any damaged cables.
- 5 If none of these steps work, you may have faulty hardware and should contact your NAP vendor.

[The LED does not behave as expected.](#)

- 1 Make sure you understand the normal behavior of the LED. See [Section 1.5 on page 8](#).
- 2 Check the hardware connections. See the Quick Start Guide.
- 3 Inspect your cables for damage. Contact the vendor to replace any damaged cables.
- 4 Disconnect and re-connect the power adaptor or PoE power injector to the NAP.

- 5 If the problem continues, contact the vendor.

5.3 NAP Access and Login

I forgot the IP address for the NAP.

- 1 The default static IP address is 192.168.1.2. If you changed the IP address and have forgotten it, you have to reset the device to its factory defaults. See [Section 5.6 on page 29](#).
- 2 If your NAP is a DHCP client, you can find your IP address from the DHCP server. This information is available from the DHCP server which allocates IP addresses on your network. Find this information directly from the DHCP server or contact your system administrator for more information.
- 3 If the NCC has managed the NAP, you can also check the NCC's **AP > Monitor > Access Point** screen for the NAP's current LAN IP address.

I cannot see or access the **Login** screen in the web configurator.

- 1 Make sure you are using the correct IP address.
 - The default static IP address is 192.168.1.2.
 - If you changed the IP address, use the new IP address.
 - If you changed the IP address and have forgotten it, see the troubleshooting suggestions for [I forgot the IP address for the NAP](#).
 - If the NCC has managed the NAP, you can check the NCC's **AP > Monitor > Access Point** screen for the NAP's current LAN IP address.
- 2 Check the hardware connections, and make sure the LED is behaving as expected. See the Quick Start Guide and [Section 1.5 on page 8](#).
- 3 Make sure your Internet browser does not block pop-up windows and has JavaScripts and Java enabled.
- 4 Make sure your computer is in the same subnet as the NAP. (If you know that there are routers between your computer and the NAP, skip this step.)
 - If there is a DHCP server on your network, make sure your computer is using a dynamic IP address.
 - If there is no DHCP server on your network, make sure your computer's IP address is in the same subnet as the NAP.
- 5 Reset the device to its factory defaults, and try to access the NAP with the default IP address. See [Section 5.6 on page 29](#).
- 6 If the problem continues, contact the network administrator or vendor, or try one of the advanced suggestions.

Advanced Suggestions

- If your computer is connected wirelessly, use a computer that is connected to a **LAN/ETHERNET** port.

I forgot the password.

- 1 The default password is **1234**. If the NAP is connected to the NCC and registered, check the NCC for the password.
- 2 If this does not work, you have to reset the device to its factory defaults. See [Section 5.6 on page 29](#).

I can see the **Login** screen, but I cannot log in to the NAP.

- 1 Make sure you have entered the user name and password correctly. This fields are case-sensitive, so make sure [Caps Lock] is not on.
- 2 Disconnect and re-connect the power adaptor or PoE power injector to the NAP.
- 3 If this does not work, you have to reset the device to its factory defaults. See [Section 5.6 on page 29](#).

5.4 Internet Access

I cannot access the Internet.

- 1 Check the hardware connections, and make sure the LED is behaving as expected. See the Quick Start Guide and [Section 5.2 on page 24](#).
- 2 Make sure the NAP is connected to a broadband modem or router with Internet access and your computer is set to obtain an dynamic IP address.
- 3 If you are trying to access the Internet wirelessly, make sure the wireless settings on the wireless client are the same as the settings on the NAP.
- 4 Disconnect all the cables from your device, and follow the directions in the Quick Start Guide again.
- 5 If the problem continues, contact your ISP.

I cannot access the Internet anymore. I had access to the Internet (with the NAP), but my Internet connection is not available anymore.

- 1 Check the hardware connections, and make sure the LED is behaving as expected. See the Quick Start Guide and [Section 1.5 on page 8](#).
- 2 Reboot the NAP.
- 3 If the problem continues, contact your ISP.

[The Internet connection is slow or intermittent.](#)

- 1 There might be a lot of traffic on the network. Look at the LED, and check [Section 1.5 on page 8](#). If the NAP is sending or receiving a lot of information, try closing some programs that use the Internet, especially peer-to-peer applications.
- 2 Check the signal strength. If the signal is weak, try moving the NAP closer to the NAP (if possible), and look around to see if there are any devices that might be interfering with the wireless network (microwaves, other wireless networks, and so on).
- 3 Reboot the NAP.
- 4 If the problem continues, contact the network administrator or vendor, or try one of the advanced suggestions.

5.5 Wireless Connections

[I cannot access the NAP or ping any computer from the WLAN.](#)

- 1 Make sure the wireless LAN (wireless radio) is enabled on the NAP.
- 2 Make sure the wireless adapter (installed on your computer) is working properly.
- 3 Make sure the wireless adapter (installed on your computer) is IEEE 802.11 compatible and supports the same wireless standard as the NAP's active radio.
- 4 Make sure your computer (with a wireless adapter installed) is within the transmission range of the NAP.
- 5 Check that both the NAP and your computer are using the same wireless and wireless security settings.

[Hackers have accessed my WEP-encrypted wireless LAN.](#)

WEP is extremely insecure. Its encryption can be broken by an attacker, using widely-available software. It is strongly recommended that you use a more effective security mechanism. Use the strongest security mechanism that all the wireless devices in your network support. WPA2 or WPA2-PSK is recommended.

The wireless security is not following the re-authentication timer setting I specified.

If a RADIUS server authenticates wireless stations, the re-authentication timer on the RADIUS server has priority. Change the RADIUS server's configuration if you need to use a different re-authentication timer setting.

How do I remove the NAP203 or NAP303 indoor AP from its mounting bracket?

- Find the down arrow close to the Ethernet ports, then use a thin flat tool (for example, a flat screw driver) to lift up a clip beneath the down arrow.

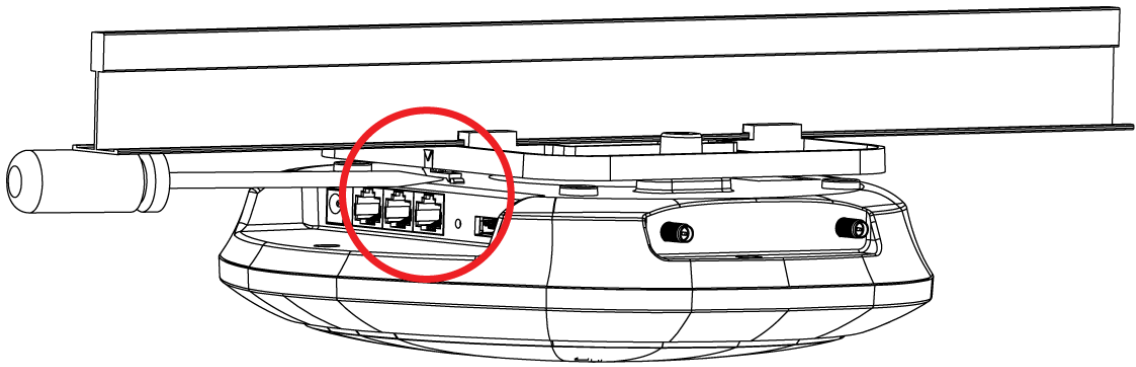

- Turn the NAP203 or NAP303 indoor AP counter-clockwise.

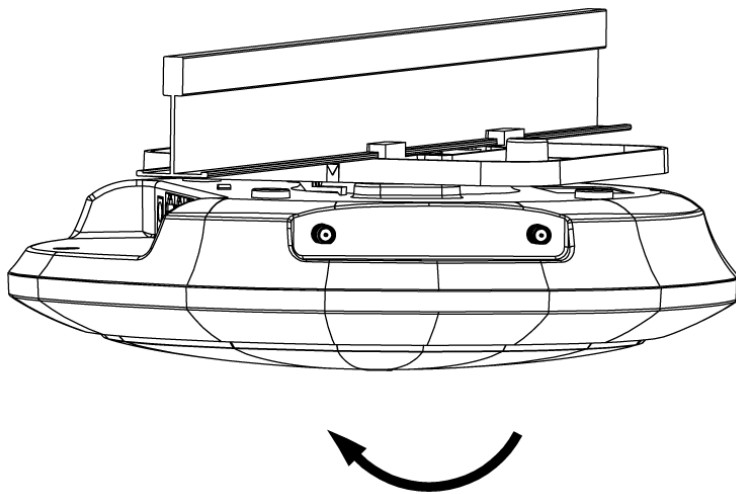

- Detach the NAP203 or NAP303 indoor AP from the mounting bracket.

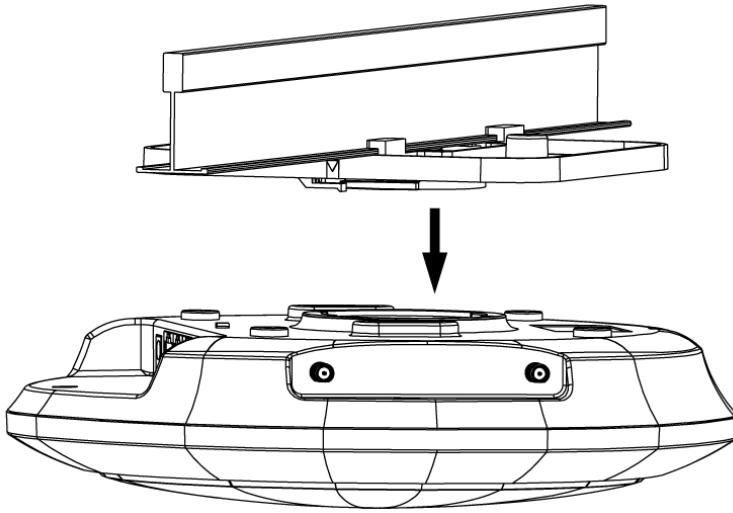

5.6 Resetting the NAP

If you cannot access the NAP by any method, try restarting it by turning the power off and then on again. If you still cannot access the NAP by any method or you forget the administrator password(s), you can reset the NAP to its factory-default settings. Any configuration files or shell scripts that you saved on the NAP should still be available afterwards.

Use the following procedure to reset the NAP to its factory-default settings. This overwrites the settings in the `startup-config.conf` file with the settings in the `system-default.conf` file.

Note: This procedure removes the current configuration.

- 1 Make sure the Power LED is on and not blinking.
- 2 Press the **RESET** button and hold it until the Power LED begins to blink. (This usually takes about ten seconds.)
- 3 Release the **RESET** button, and wait for the NAP to restart.

You should be able to access the NAP using the default settings.

5.7 Getting More Troubleshooting Help

Search for support information for your model at www.zyxel.com for more troubleshooting suggestions.

APPENDIX A

Customer Support

In the event of problems that cannot be solved by using this manual, you should contact your vendor. If you cannot contact your vendor, then contact a Zyxel office for the region in which you bought the device.

See <http://www.zyxel.com/homepage.shtml> and also http://www.zyxel.com/about_zyxel/zyxel_worldwide.shtml for the latest information.

Please have the following information ready when you contact an office.

Required Information

- Product model and serial number.
- Warranty Information.
- Date that you received your device.
- Brief description of the problem and the steps you took to solve it.

Corporate Headquarters (Worldwide)

Taiwan

- Zyxel Communications Corporation
- <http://www.zyxel.com>

Asia

China

- Zyxel Communications (Shanghai) Corp.
- Zyxel Communications (Beijing) Corp.
- Zyxel Communications (Tianjin) Corp.
- <http://www.zyxel.cn>

India

- Zyxel Technology India Pvt Ltd
- <http://www.zyxel.in>

Kazakhstan

- Zyxel Kazakhstan
- <http://www.zyxel.kz>

Korea

- Zyxel Korea Corp.
- <http://www.zyxel.kr>

Malaysia

- Zyxel Malaysia Sdn Bhd.
- <http://www.zyxel.com.my>

Pakistan

- Zyxel Pakistan (Pvt.) Ltd.
- <http://www.zyxel.com.pk>

Philippines

- Zyxel Philippines
- <http://www.zyxel.com.ph>

Singapore

- Zyxel Singapore Pte Ltd.
- <http://www.zyxel.com.sg>

Taiwan

- Zyxel Communications Corporation
- <http://www.zyxel.com/tw/zh/>

Thailand

- Zyxel Thailand Co., Ltd
- <http://www.zyxel.co.th>

Vietnam

- Zyxel Communications Corporation-Vietnam Office
- <http://www.zyxel.com/vn/vi>

Europe

Austria

- Zyxel Deutschland GmbH
- <http://www.zyxel.de>

Belarus

- Zyxel BY
- <http://www.zyxel.by>

Belgium

- Zyxel Communications B.V.
- <http://www.zyxel.com/be/nl/>
- <http://www.zyxel.com/be/fr/>

Bulgaria

- Zyxel България
- <http://www.zyxel.com/bg/bg/>

Czech Republic

- Zyxel Communications Czech s.r.o
- <http://www.zyxel.cz>

Denmark

- Zyxel Communications A/S
- <http://www.zyxel.dk>

Estonia

- Zyxel Estonia
- <http://www.zyxel.com/ee/et/>

Finland

- Zyxel Communications
- <http://www.zyxel.fi>

France

- Zyxel France
- <http://www.zyxel.fr>

Germany

- Zyxel Deutschland GmbH
- <http://www.zyxel.de>

Hungary

- Zyxel Hungary & SEE
- <http://www.zyxel.hu>

Italy

- Zyxel Communications Italy
- <http://www.zyxel.it/>

Latvia

- Zyxel Latvia
- <http://www.zyxel.com/lv/lv/homepage.shtml>

Lithuania

- Zyxel Lithuania
- <http://www.zyxel.com/lt/lt/homepage.shtml>

Netherlands

- Zyxel Benelux
- <http://www.zyxel.nl>

Norway

- Zyxel Communications
- <http://www.zyxel.no>

Poland

- Zyxel Communications Poland
- <http://www.zyxel.pl>

Romania

- Zyxel Romania
- <http://www.zyxel.com/ro/ro>

Russia

- Zyxel Russia
- <http://www.zyxel.ru>

Slovakia

- Zyxel Communications Czech s.r.o. organizacna zlozka
- <http://www.zyxel.sk>

Spain

- Zyxel Communications ES Ltd
- <http://www.zyxel.es>

Sweden

- Zyxel Communications
- <http://www.zyxel.se>

Switzerland

- Studerus AG

- <http://www.zyxel.ch/>

Turkey

- Zyxel Turkey A.S.
- <http://www.zyxel.com.tr>

UK

- Zyxel Communications UK Ltd.
- <http://www.zyxel.co.uk>

Ukraine

- Zyxel Ukraine
- <http://www.ua.zyxel.com>

Latin America

Argentina

- Zyxel Communication Corporation
- <http://www.zyxel.com/ec/es/>

Brazil

- Zyxel Communications Brasil Ltda.
- <https://www.zyxel.com/br/pt/>

Ecuador

- Zyxel Communication Corporation
- <http://www.zyxel.com/ec/es/>

Middle East

Israel

- Zyxel Communication Corporation
- <http://il.zyxel.com/homepage.shtml>

Middle East

- Zyxel Communication Corporation
- <http://www.zyxel.com/me/en/>

North America

USA

- Zyxel Communications, Inc. - North America Headquarters
- <http://www.zyxel.com/us/en/>

Oceania

Australia

- Zyxel Communications Corporation
- <http://www.zyxel.com/au/en/>

Africa

South Africa

- Nology (Pty) Ltd.
- <http://www.zyxel.co.za>

APPENDIX B

Legal Information

Copyright

Copyright © 2017 by Zyxel Communications Corporation.

The contents of this publication may not be reproduced in any part or as a whole, transcribed, stored in a retrieval system, translated into any language, or transmitted in any form or by any means, electronic, mechanical, magnetic, optical, chemical, photocopying, manual, or otherwise, without the prior written permission of Zyxel Communications Corporation.

Published by Zyxel Communications Corporation. All rights reserved.

Disclaimers

Zyxel does not assume any liability arising out of the application or use of any products, or software described herein. Neither does it convey any license under its patent rights nor the patent rights of others. Zyxel further reserves the right to make changes in any products described herein without notice. This publication is subject to change without notice.

Your use of the NAP is subject to the terms and conditions of any related service providers.

Trademarks

Trademarks mentioned in this publication are used for identification purposes only and may be properties of their respective owners.

Regulatory Notice and Statement

UNITED STATES of AMERICA



The following information applies if you use the product within USA area.

FCC EMC Statement

- The device complies with Part 15 of FCC rules. Operation is subject to the following two conditions:
 - (1) This device may not cause harmful interference, and
 - (2) This device must accept any interference received, including interference that may cause undesired operation.
- Changes or modifications not expressly approved by the party responsible for compliance could void the user's authority to operate the device.
- This product has been tested and complies with the specifications for a Class B digital device, pursuant to Part 15 of the FCC Rules. These limits are designed to provide reasonable protection against harmful interference in a residential installation. This device generates, uses, and can radiate radio frequency energy and, if not installed and used according to the instructions, may cause harmful interference to radio communications. However, there is no guarantee that interference will not occur in a particular installation.
- If this device does cause harmful interference to radio or television reception, which is found by turning the device off and on, the user is encouraged to try to correct the interference by one or more of the following measures:
 - Reorient or relocate the receiving antenna
 - Increase the separation between the devices
 - Connect the equipment to an outlet other than the receiver's
 - Consult a dealer or an experienced radio/TV technician for assistance

FCC Radiation Exposure Statement

- This device complies with FCC RF radiation exposure limits set forth for an uncontrolled environment.
- This transmitter must be at least 20 cm (NAP102, NAP203, NAP303) or 30 cm (NAP353) from the user and must not be co-located or operating in conjunction with any other antenna or transmitter.
- Country Code selection feature to be disabled for products marketed to the US/CANADA
- Operation of this device is restricted to indoor use only. (NAP353 is a device for outdoor use.)

“Este equipamento opera em caráter secundário, isto é, não tem direito à proteção contra interferência prejudicial, mesmo de estações do mesmo tipo, e não pode causar interferência a sistemas operando em caráter primário.”

CANADA

The following information applies if you use the product within Canada area.

Industry Canada ICES statement

CAN ICES-3 (B)/NMB-3(B)

Industry Canada RSS-GEN & RSS-247 statement

- This device complies with Industry Canada license-exempt RSS standard(s). Operation is subject to the following two conditions: (1) this device may not cause interference, and (2) this device must accept any interference, including interference that may cause undesired operation of the device.
- This radio transmitter (2468C-NWA5123AC (NAP102), 2468C-WAC6503DS (NAP303), 2468C-WAC6553DE (NAP353), 2468C-WAC6103DI (NAP203)) has been approved by Industry Canada to operate with the antenna types listed below with the maximum permissible gain and required antenna impedance for each antenna type indicated. Antenna types not included in this list, having a gain greater than the maximum gain indicated for that type, are strictly prohibited for use with this device.

Antenna Information

ANTENNA MODEL	NO.	TYPE	CONNECTOR	2.4 G GAIN	5 G GAIN	REMARK
NAP102 2.4 GHz Antenna	1	PIFA	U.FL	3.08 (2400-2483.5MHz)		
	2	PIFA	U.FL	3.07 (2400-2483.5MHz)		
NAP102 5 GHz Antenna	3	PIFA	U.FL		4.06 (5150-5250 MHz) 3.91 (5725-5850 MHz)	
	4	PIFA	U.FL		3.99 (5150-5250 MHz) 3.79 (5725-5850 MHz)	
NAP303		Dipole	IPEX	4	6	
ZXL04-22008A		Dipole	N type	4.5	7	
SINBON / 2.4 G & 5 G Metal & PCB Antenna	1	PIFA	U.FL	3.28		Ceiling Mounted: Antenna 1, 2, 3 Wall Mounted: Antenna 1, 2, 4
	2	PIFA	U.FL	3.37		
	3	PIFA	U.FL	3.15		
	4	Dipole	U.FL	4.33		
	5	Loop	U.FL		4.38 (5150-5250 MHz) 4.23 (5725-5850 MHz)	Ceiling Mounted: Antenna 5, 6, 7 Wall Mounted: Antenna 5, 6, 8
	6	Loop	U.FL		4.31 (5150-5250 MHz) 4.22 (5725-5850 MHz)	
	7	Loop	U.FL		4.38 (5150-5250 MHz) 4.36 (5725-5850 MHz)	
	8	Dipole	U.FL		5.12 (5150-5250 MHz) 5.20 (5725-5850 MHz)	

If the product with 5G wireless function operating in 5150-5250 MHz and 5725-5850 MHz , the following attention must be paid.

- The device for operation in the band 5150-5250 MHz is only for indoor use to reduce the potential for harmful interference to co-channel mobile satellite systems.
- For devices with detachable antenna(s), the maximum antenna gain permitted for devices in the band 5725-5850 MHz shall be such that the equipment still complies with the e.i.r.p. limits specified for point-to-point and non-point-to-point operation as appropriate; and
- The worst-case tilt angle(s) necessary to remain compliant with the e.i.r.p. elevation mask requirement set forth in Section 6.2.2(3) of RSS 247 shall be clearly indicated.

If the product with 5G wireless function operating in 5250-5350 MHz and 5470-5725 MHz , the following attention must be paid.

- For devices with detachable antenna(s), the maximum antenna gain permitted for devices in the bands 5250-5350 MHz and 5470-5725 MHz shall be such that the equipment still complies with the e.i.r.p. limit.
- Le présent appareil est conforme aux CNR d'Industrie Canada applicables aux appareils radio exempts de licence. L'exploitation est autorisée aux deux conditions suivantes : (1) l'appareil ne doit pas produire de brouillage, et (2) l'utilisateur de l'appareil doit accepter tout brouillage radioélectrique subi, même si le brouillage est susceptible d'en compromettre le fonctionnement.
- Le présent émetteur radio (2468C-NWA5123AC (NAP102), 2468C-WAC6503DS (NAP303), 2468C-WAC6553DE (NAP353), 2468C-WAC6103DI (NAP203)) de modèle s'il fait partie du matériel de catégoriel) a été approuvé par Industrie Canada pour fonctionner avec les types d'antenne énumérés ci-dessous et ayant un gain admissible maximal et l'impédance requise pour chaque type d'antenne. Les types d'antenne non inclus dans cette liste, ou dont le gain est supérieur au gain maximal indiqué, sont strictement interdits pour l'exploitation de l'émetteur.

Informations Antenne

MODELE D'ANTENNE	NOMBRE	TYPE	CONNECTEUR	2.4 G GAIN	5 G GAIN	REMARQUE
NAP102 2.4 GHz Antenna	1	PIFA	U.FL	3.08 (2400-2483.5MHz)		
	2	PIFA	U.FL	3.07 (2400-2483.5MHz)		
NAP102 5 GHz Antenna	3	PIFA	U.FL		4.06 (5150-5250 MHz) 3.91 (5725-5850 MHz)	
	4	PIFA	U.FL		3.99 (5150-5250 MHz) 3.79 (5725-5850 MHz)	
NAP303		Dipole	IPEX	4	6	
ZXL04-22008A		Dipole	N type	4.5	7	
SINBON / 2.4 G & 5 G Metal & PCB Antenna	1	PIFA	U.FL	3.28		Ceiling Mounted: Antenna 1, 2, 3
	2	PIFA	U.FL	3.37		
	3	PIFA	U.FL	3.15		Wall Mounted: Antenna 1, 2, 4
	4	Dipole	U.FL	4.33		
	5	Loop	U.FL		4.38 (5150-5250 MHz) 4.23 (5725-5850 MHz)	Ceiling Mounted: Antenna 5, 6, 7
	6	Loop	U.FL		4.31 (5150-5250 MHz) 4.22 (5725-5850 MHz)	
	7	Loop	U.FL		4.38 (5150-5250 MHz) 4.36 (5725-5850 MHz)	Wall Mounted: Antenna 5, 6, 8
	8	Dipole	U.FL		5.12 (5150-5250 MHz) 5.20 (5725-5850 MHz)	

Lorsque la fonction sans fil 5G fonctionnant en 5150-5250 MHz and 5725-5850 MHz est activée pour ce produit , il est nécessaire de porter une attention particulière aux choses suivantes

- Les dispositifs fonctionnant dans la bande 5150-5250 MHz sont réservés uniquement pour une utilisation à l'intérieur afin de réduire les risques de brouillage préjudiciable aux systèmes de satellites mobiles utilisant les mêmes canaux;
- Pour les dispositifs munis d'antennes amovibles, le gain maximal d'antenne permis (pour les dispositifs utilisant la bande de 5 725 à 5 850 MHz) doit être conforme à la limite de la p.i.r.e. spécifiée pour l'exploitation point à point et l'exploitation non point à point, selon le cas;
- Les pires angles d'inclinaison nécessaires pour rester conforme à l'exigence de la p.i.r.e. applicable au masque d'élévation, et énoncée à la section 6.2.2.3) du CNR-247, doivent être clairement indiqués.

Lorsque la fonction sans fil 5G fonctionnant en 5250-5350 MHz et 5470-5725 MHz est activée pour ce produit , il est nécessaire de porter une attention particulière aux choses suivantes.

- Pour les dispositifs munis d'antennes amovibles, le gain maximal d'antenne permis pour les dispositifs utilisant les bandes de 5 250 à 5 350 MHz et de 5 470 à 5 725 MHz doit être conforme à la limite de la p.i.r.e..

Industry Canada radiation exposure statement

This equipment complies with IC radiation exposure limits set forth for an uncontrolled environment. This equipment should be installed and operated with a minimum distance of 20 cm (NAP102, NAP203, NAP303) between the radiator and your body.

This equipment complies with IC radiation exposure limits set forth for an uncontrolled environment. This equipment should be installed and operated with a minimum distance of 30 cm (NAP353) between the radiator and your body.

Déclaration d'exposition aux radiations:

Cet équipement est conforme aux limites d'exposition aux rayonnements IC établies pour un environnement non contrôlé. Cet équipement doit être installé et utilisé avec un minimum de 20 cm (NAP102, NAP203, NAP303) de distance entre la source de rayonnement et votre corps.

Cet équipement est conforme aux limites d'exposition aux rayonnements IC établies pour un environnement non contrôlé. Cet équipement doit être installé et utilisé avec un minimum de 30 cm (NAP353) de distance entre la source de rayonnement et votre corps.

Caution:

- (i) the device for operation in the band 5150-5250 MHz is only for indoor use to reduce the potential for harmful interference to co-channel mobile satellite systems;
- (ii) the maximum antenna gain permitted for devices in the bands 5250-5350 MHz and 5470-5725 MHz shall comply with the e.i.r.p. limit; and
- (iii) the maximum antenna gain permitted for devices in the band 5725-5825 MHz shall comply with the e.i.r.p. limits specified for point-to-point and non point-to-point operation as appropriate.
- (iv) Users should also be advised that high-power radars are allocated as primary users (i.e. priority users) of the bands 5250-5350 MHz and 5650-5850 MHz and that these radars could cause interference and/or damage to LE-LAN devices.
- (v) NAP353 is an outdoor device and only uses 5G Band 4 (5725-5850 MHz).

Avertissement:

- (i) les dispositifs fonctionnant dans la bande 5150-5250 MHz sont réservés uniquement pour une utilisation à l'intérieur afin de réduire les risques de brouillage préjudiciable aux systèmes de satellites mobiles utilisant les mêmes canaux;

- (ii) le gain maximal d'antenne permis pour les dispositifs utilisant les bandes 5250-5350 MHz et 5 470-5 725 MHz doit se conformer à la limite de p.i.r.e.;
- (iii) le gain maximal d'antenne permis (pour les dispositifs utilisant la bande 5725-5825 MHz) doit se conformer à la limite de p.i.r.e. spécifiée pour l'exploitation point à point et non point à point, selon le cas.
- (iv) De plus, les utilisateurs devraient aussi être avisés que les utilisateurs de radars de haute puissance sont désignés utilisateurs principaux (c.-à-d., qu'ils ont la priorité) pour les bandes 5250-5350 MHz et 5650-5850 MHz et que ces radars pourraient causer du brouillage et/ou des dommages aux dispositifs LAN-EL.
- (v) NAP353 est un appareil extérieur et seulement utilise 5G Bane 4 (5725-5850 MHz).

EUROPEAN UNION



The following information applies if you use the product within the European Union.

Declaration of Conformity with Regard to EU Directive 1999/5/EC (R&TTE Directive)

- Compliance information for 2.4GHz and/or 5GHz wireless products relevant to the EU and other Countries following the EU Directive 1999/5/EC (R&TTE).

Български (Bulgarian)	С настоящото Zyxel декларира, че това оборудване е в съответствие със съществените изисквания и другите приложими разпоредбите на Директива 1999/5/EC.
Español (Spanish)	Por medio de la presente Zyxel declara que el equipo cumple con los requisitos esenciales y cualesquiera otras disposiciones aplicables o exigibles de la Directiva 1999/5/CE.
Čeština (Czech)	Zyxel tímto prohlašuje, že tento zařízení je ve shodě se základními požadavky a dalšími příslušnými ustanoveními směrnice 1999/5/EC.
Dansk (Danish)	Undertegnede Zyxel erklærer herved, at følgende udstyr overholder de væsentlige krav og øvrige relevante krav i direktiv 1999/5/EF.
Deutsch (German)	Hiermit erklärt Zyxel, dass sich das Gerät Ausstattung in Übereinstimmung mit den grundlegenden Anforderungen und den übrigen einschlägigen Bestimmungen der Richtlinie 1999/5/EU befindet.
Eesti keel (Estonian)	Käesolevaga kinnitab Zyxel seadme seadmed vastavust direktiivi 1999/5/EÜ põhinõuetele ja nimetatud direktiivist tulenevatele teistele asjakohastele sätetele.
Ελληνικά (Greek)	ΜΕ ΤΗΝ ΠΑΡΟΥΣΙΑ Ζyxel ΔΗΛΩΝΕΙ ΟΤΙ ΕΞΟΤΙΣΜΟΣ ΣΥΜΜΟΡΦΩΝΕΤΑΙ ΠΡΟΣ ΤΙΣ ΟΥΣΙΩΔΕΙΣ ΑΠΑΙΤΗΣΕΙΣ ΚΑΙ ΤΙΣ ΛΟΙΠΕΣ ΣΧΕΤΙΚΕΣ ΔΙΑΤΑΞΕΙΣ ΤΗΣ ΟΔΗΓΙΑΣ 1999/5/EC.
English	Hereby, Zyxel declares that this equipment is in compliance with the essential requirements and other relevant provisions of Directive 1999/5/EC.
Français (French)	Par la présente Zyxel déclare que l'appareil équipements est conforme aux exigences essentielles et aux autres dispositions pertinentes de la directive 1999/5/EC.
Hrvatski (Croatian)	Zyxel ovime izjavljuje da je radijska oprema tipa u skladu s Direktivom 1999/5/EC.
Íslenska (Icelandic)	Hér með lýsir, Zyxel því yfir að þessi búnaður er í samræmi við grunnkröfur og önnur viðeigandi ákvæði tilskipunar 1999/5/EC.
Italiano (Italian)	Con la presente Zyxel dichiara che questo attrezzatura è conforme ai requisiti essenziali ed alle altre disposizioni pertinenti stabilite dalla direttiva 1999/5/CE.
Latviešu valoda (Latvian)	Ar šo Zyxel deklarē, ka iekārtas atbilst Direktīvas 1999/5/EK būtiskajām prasībām un citiem ar to saistītajiem noteikumiem.
Lietuvių kalba (Lithuanian)	Šiuo Zyxel deklaruoja, kad šis įranga atitinka esminius reikalavimus ir kitas 1999/5/EB Direktyvos nuostatas.
Magyar (Hungarian)	Alulírott, Zyxel nyilatkozom, hogy a berendezés megfelel a vonatkozó alapvető követelményeknek és az 1999/5/EK irányelv egyéb előírásainak.
Malti (Maltese)	Hawnhekk, Zyxel, jiddikjara li dan tagħmir jikkonforma mal-htigijiet essenzjali u ma provvedimenti oħrajn relevanti li hemm fid-Direttiva 1999/5/EC.
Nederlands (Dutch)	Hierbij verklaart Zyxel dat het toestel uitrusting in overeenstemming is met de essentiële eisen en de andere relevante bepalingen van richtlijn 1999/5/EC.
Polski (Polish)	Niniejszym Zyxel oświadcza, że sprzęt jest zgodny z zasadniczymi wymogami oraz pozostałymi stosownymi postanowieniami Dyrektywy 1999/5/EC.
Português (Portuguese)	Zyxel declara que este equipamento está conforme com os requisitos essenciais e outras disposições da Directiva 1999/5/EC.
Română (Romanian)	Prin prezenta, Zyxel declară că acest echipament este în conformitate cu cerințele esențiale și alte prevederi relevante ale Directivei 1999/5/EC.

Slovenčina (Slovak)	Zyxel týmto vyhlasuje, že zariadenia spĺňa základné požiadavky a všetky príslušné ustanovenia Smernice 1999/5/EC.
Slovenščina (Slovene)	Zyxel izjavlja, da je ta oprema v skladu z bistvenimi zahtevami in ostalimi relevantnimi določili direktive 1999/5/EC.
Suomi (Finnish)	Zyxel vakuuttaa täten että laitteet tyyppinen laite on direktiivin 1999/5/EY oleellisten vaatimusten ja sitä koskevien direktiivin muiden ehtojen mukainen.
Svenska (Swedish)	Härmed intygar Zyxel att denna utrustning står i överensstämmelse med de väsentliga egenskapskrav och övriga relevanta bestämmelser som framgår av direktiv 1999/5/EC.
Norsk (Norwegian)	Erklærer herved Zyxel at dette utstyret er i samsvar med de grunnleggende kravene og andre relevante bestemmelser i direktiv 1999/5/EF.

- This device is restricted to indoor use only when operating in the 5150 to 5350 MHz frequency range.

National Restrictions

- This product may be used in all EU countries (and other countries following the EU Directive 1999/5/EC) without any limitation except for the countries mentioned below:
- Ce produit peut être utilisé dans tous les pays de l'UE (et dans tous les pays ayant transposés la directive 1999/5/CE) sans aucune limitation, excepté pour les pays mentionnés ci-dessous:
- Questo prodotto è utilizzabile in tutte i paesi EU (ed in tutti gli altri paesi che seguono le direttiva 1999/5/EC) senza nessuna limitazione, eccetto per i paesi menzionati di seguito:
- Das Produkt kann in allen EU Staaten ohne Einschränkungen eingesetzt werden (sowie in anderen Staaten die der Richtlinie 1999/5/CE folgen) mit Ausnahme der folgenden aufgeführten Staaten:

In the majority of the EU and other European countries, the 2.4GHz and 5GHz bands have been made available for the use of wireless local area networks (LANs). Later in this document you will find an overview of countries in which additional restrictions or requirements or both are applicable. The requirements for any country may evolve. Zyxel recommends that you check with the local authorities for the latest status of their national regulations for both the 2.4GHz and 5GHz wireless LANs. The following countries have restrictions and/or requirements in addition to those given in the table labeled "Overview of Regulatory Requirements for Wireless LANs":

Belgium

- The Belgian Institute for Postal Services and Telecommunications (BIPT) must be notified of any outdoor wireless link having a range exceeding 300 meters. Please check <http://www.bipt.be> for more details.
- Draadloze verbindingen voor buitengebruik en met een reikwijdte van meer dan 300 meter dienen aangemeld te worden bij het Belgisch Instituut voor postdiensten en telecommunicatie (BIPT). Zie <http://www.bipt.be> voor meer gegevens.
- Les liaisons sans fil pour une utilisation en extérieur d'une distance supérieure à 300 mètres doivent être notifiées à l'Institut Belge des services Postaux et des Télécommunications (IBPT). Visitez <http://www.ibpt.be> pour de plus amples détails.

Denmark

- In Denmark, the band 5150 - 5350 MHz is also allowed for outdoor usage.
- I Danmark må frekvensbåndet 5150 - 5350 også anvendes udendørs.

Italy

- This product meets the National Radio Interface and the requirements specified in the National Frequency Allocation Table for Italy. Unless this wireless LAN product is operating within the boundaries of the owner's property, its use requires a "general authorization." Please check <http://www.sviluppoeconomico.gov.it/> for more details.
- Questo prodotto è conforme alla specifiche di Interfaccia Radio Nazionali e rispetta il Piano Nazionale di ripartizione delle frequenze in Italia. Se non viene installato all'interno del proprio fondo, l'utilizzo di prodotti Wireless LAN richiede una "Autorizzazione Generale". Consultare <http://www.sviluppoeconomico.gov.it/> per maggiori dettagli.

Latvia

- The outdoor usage of the 2.4 GHz band requires an authorization from the Electronic Communications Office. Please check <http://www.esd.lv> for more details.
- 2.4 GHz frekvenču joslas izmantošanai ārpus telpām nepieciešama atļauja no Elektronisko sakaru direkcijas. Vairāk informācijas: <http://www.esd.lv>.

Notes:

1. Although Norway, Switzerland and Liechtenstein are not EU member states, the EU Directive 1999/5/EC has also been implemented in those countries.
2. The regulatory limits for maximum output power are specified in EIRP. The EIRP level (in dBm) of a device can be calculated by adding the gain of the antenna used (specified in dBi) to the output power available at the connector (specified in dBm).

List of national codes

COUNTRY	ISO 3166 2 LETTER CODE	COUNTRY	ISO 3166 2 LETTER CODE
Austria	AT	Liechtenstein	LI
Belgium	BE	Lithuania	LT
Bulgaria	BG	Luxembourg	LU
Croatia	HR	Malta	MT
Cyprus	CY	Netherlands	NL
Czech Republic	CR	Norway	NO
Denmark	DK	Poland	PL
Estonia	EE	Portugal	PT
Finland	FI	Romania	RO
France	FR	Serbia	RS
Germany	DE	Slovakia	SK
Greece	GR	Slovenia	SI
Hungary	HU	Spain	ES
Iceland	IS	Sweden	SE
Ireland	IE	Switzerland	CH
Italy	IT	Turkey	TR
Latvia	LV	United Kingdom	GB

Professional installation instruction (NAP353)

Please be advised that due to the unique function supplied by this product, the device is intended for use with our interactive entertainment software and licensed third-party only. The product will be distributed through controlled distribution channel and installed by trained professional and will not be sold directly to the general public through retail store.

- 1 Installation personal
This product is designed for specific application and needs to be installed by a qualified personal who has RF and related rule knowledge. The general user shall not attempt to install or change the setting.
- 2 Installation location
The product shall be installed at a location where the radiating antenna can be kept 30 cm from nearby person in normal operation condition to meet regulatory RF exposure requirement.
- 3 External antenna
Use only the antennas which have been approved by Zyxel Communications Corporation. The non-approved antenna(s) may produce unwanted spurious or excessive RF transmitting power which may lead to the violation of FCC/IC limit and is prohibited.
- 4 Installation procedure
Please refer to user's manual for the detail.
- 5 Warning
Please carefully select the installation position and make sure that the final output power does not exceed the limit set force in relevant rules. The violation of the rule could lead to serious federal penalty.

Instructions d'installation professionnelle (NAP353)

Veillez noter que l'appareil étant dédié à une fonction unique, il doit être utilisé avec notre logiciel propriétaire de divertissement interactif. Ce produit sera proposé par un réseau de distribution contrôlé et installé par des professionnels; il ne sera pas proposé au grand public par le réseau de la grande distribution.

- 1 Installation
Ce produit est destiné à un usage spécifique et doit être installé par un personnel qualifié maîtrisant les radiofréquences et les règles s'y rapportant. L'installation et les réglages ne doivent pas être modifiés par l'utilisateur final.
- 2 Emplacement d'installation
En usage normal, afin de respecter les exigences réglementaires concernant l'exposition aux radiofréquences, ce produit doit être installé de façon à respecter une distance de 30 cm entre l'antenne émettrice et les personnes.
- 3 Antenne externe.
Utiliser uniquement les antennes approuvées par le fabricant. L'utilisation d'autres antennes peut conduire à un niveau de rayonnement essentiel ou non essentiel dépassant les niveaux limites définis par FCC/IC, ce qui est interdit.
- 4 Procédure d'installation
Consulter le manuel d'utilisation.
- 5 Avertissement
Choisir avec soin la position d'installation et s'assurer que la puissance de sortie ne dépasse pas les limites en vigueur. La violation de cette règle peut conduire à de sérieuses pénalités fédérales.

Safety Warnings

- Do not use this product near water, for example, in a wet basement or near a swimming pool.
- Do not expose your device to dampness, dust or corrosive liquids.
- Do not store things on the device.
- Do not obstruct the device ventilation slots as insufficient airflow may harm your device. For example, do not place the device in an enclosed space such as a box or on a very soft surface such as a bed or sofa.
- Do not install, use, or service this device during a thunderstorm. There is a remote risk of electric shock from lightning.
- Connect ONLY suitable accessories to the device.
- Do not open the device or unit. Opening or removing covers can expose you to dangerous high voltage points or other risks. ONLY qualified service personnel should service or disassemble this device. Please contact your vendor for further information.
- Make sure to connect the cables to the correct ports.
- Place connecting cables carefully so that no one will step on them or stumble over them.
- Always disconnect all cables from this device before servicing or disassembling.
- Do not remove the plug and connect it to a power outlet by itself; always attach the plug to the power adaptor first before connecting it to a power outlet.
- Do not allow anything to rest on the power adaptor or cord and do NOT place the product where anyone can walk on the power adaptor or cord.
- Please use the provided or designated connection cables/power cables/ adaptors. Connect it to the right supply voltage (for example, 110V AC in North America or 230V AC in Europe). If the power adaptor or cord is damaged, it might cause electrocution. Remove it from the device and the power source; repairing the power adapter or cord is prohibited. Contact your local vendor to order a new one.
- Do not use the device outside, and make sure all the connections are indoors. There is a remote risk of electric shock from lightning.
- Caution: risk of explosion if battery (on the motherboard) is replaced by an incorrect type. dispose of used batteries according to the instructions. Dispose them at the applicable collection point for the recycling of electrical and electronic device. For detailed information about recycling of this product, please contact your local city office, your household waste disposal service or the store where you purchased the product.
- Antenna Warning! This device meets ETSI and FCC certification requirements when using the included antenna(s). Only use the included antenna(s).
- If you wall mount your device, make sure that no electrical lines, gas or water pipes will be damaged.
- The PoE (Power over Ethernet) devices that supply or receive power and their connected Ethernet cables must all be completely indoors.
- This product is for indoor use only (utilisation intérieure exclusive).
- FOR COUNTRY CODE SELECTION USAGE (WLAN DEVICES)
Note: The country code selection is for non-US model only and is not available to all US model. Per FCC regulation, all Wi-Fi product marketed in US must fixed to US operation channels only.
- The following warning statements apply, where the disconnect device is not incorporated in the device or where the plug on the power supply cord is intended to serve as the disconnect device,
 - For permanently connected devices, a readily accessible disconnect device shall be incorporated external to the device;
 - For pluggable devices, the socket-outlet shall be installed near the device and shall be easily accessible.

Environment statement

ErP (Energy-related Products)

Zyxel products put on the EU market in compliance with the requirement of the European Parliament and the Council published Directive 2009/125/EC establishing a framework for the setting of ecodesign requirements for energy-related products (recast), so called as "ErP Directive (Energy-related Products directive) as well as ecodesign requirement laid down in applicable implementing measures, power consumption has satisfied regulation requirements which are:

- Network standby power consumption < 8W, and/or
- Off mode power consumption < 0.5W, and/or
- Standby mode power consumption < 0.5W.

(Wireless setting, please refer to "Wireless" chapter for more detail.)

European Union - Disposal and Recycling Information

The symbol below means that according to local regulations your product and/or its battery shall be disposed of separately from domestic waste. If this product is end of life, take it to a recycling station designated by local authorities. At the time of disposal, the separate collection of your product and/or its battery will help save natural resources and ensure that the environment is sustainable development.

Die folgende Symbol bedeutet, dass Ihr Produkt und/oder seine Batterie gemäß den örtlichen Bestimmungen getrennt vom Hausmüll entsorgt werden muss. Wenden Sie sich an eine Recyclingstation, wenn dieses Produkt das Ende seiner Lebensdauer erreicht hat. Zum Zeitpunkt der Entsorgung wird die getrennte Sammlung von Produkt und/oder seiner Batterie dazu beitragen, natürliche Ressourcen zu sparen und die Umwelt und die menschliche Gesundheit zu schützen.

El símbolo de abajo indica que según las regulaciones locales, su producto y/o su batería deberán depositarse como basura separada de la doméstica. Cuando este producto alcance el final de su vida útil, llévelo a un punto limpio. Cuando llegue el momento de desechar el producto, la recogida por separado éste y/o su batería ayudará a salvar los recursos naturales y a proteger la salud humana y medioambiental.















































Le symbole ci-dessous signifie que selon les réglementations locales votre produit et/ou sa batterie doivent être éliminés séparément des ordures ménagères. Lorsque ce produit atteint sa fin de vie, amenez-le à un centre de recyclage. Au moment de la mise au rebut, la collecte séparée de votre produit et/ou de sa batterie aidera à économiser les ressources naturelles et protéger l'environnement et la santé humaine.

Il simbolo sotto significa che secondo i regolamenti locali il vostro prodotto e/o batteria deve essere smaltito separatamente dai rifiuti domestici. Quando questo prodotto raggiunge la fine della vita di servizio portarlo a una stazione di riciclaggio. Al momento dello smaltimento, la raccolta separata del vostro prodotto e/o della sua batteria aiuta a risparmiare risorse naturali e a proteggere l'ambiente e la salute umana.

Symbolen innebär att enligt lokal lagstiftning ska produkten och/eller dess batteri kastas separat från hushållsavfallet. När den här produkten når slutet av sin livslängd ska du ta den till en återvinningsstation. Vid tiden för kasseringen bidrar du till en bättre miljö och mänsklig hälsa genom att göra dig av med den på ett återvinningsställe.



Environmental Product Declaration

Български (Bulgarian)	Čeština (Czech)	Dansk (Danish)	Deutsch (German)
<p>Екологична продуктова декларация</p> <p>RoHS Директива 2011/65/EC WEEE Директива 2012/19/EC PPW Директива 94/62/EC REACH Регламент (ЕС) № 1907/2006 ErP Директива 2009/125/EC</p> <p>Име/ титла : Richard Hsu / Quality Management Division Senior Manager Подпис : Дата (dd/mm/yyyy) : 01/10/2014</p>  	<p>Environmentální prohlášení o produktu</p> <p>RoHS Směrnice 2011/65/EU WEEE Směrnice 2012/19/EU PPW Směrnice 94/62/EC REACH Nařízení (ES) č. 1907/2006 ErP Směrnice 2009/125/ES</p> <p>Jméno/ titul : Richard Hsu / Quality Management Division Senior Manager Podpis : Datum (dd/mm/yyyy) : 01/10/2014</p>  	<p>Miljøerklæring</p> <p>RoHS Direktiv 2011/65/EU WEEE Direktiv 2012/19/EU PPW Direktiv 94/62/EF REACH Forordning (EF) nr. 1907/2006 ErP Direktiv 2009/125/EF</p> <p>Navn/ titel : Richard Hsu / Quality Management Division Senior Manager Underskrift : Dato (dd/mm/åååå) : 01/10/2014</p>  	<p>Produkt-Umweltdeklaration</p> <p>RoHS Richtlinie 2011/65/EU WEEE Richtlinie 2012/19/EU PPW Richtlinie 94/62/EG REACH VERORDNUNG (EG) Nr. 1907/2006 ErP Richtlinie 2009/125/EG</p> <p>Name/ titel : Richard Hsu / Quality Management Division Senior Manager Unterschrift : Datum (dd/mm/yyyy) : 2014/10/01</p>  
Eesti keel (Estonian)	English	Español (Spanish)	Français (French)
<p>Toote keskkonnadeklaratsioon</p> <p>RoHS Direktiiv 2011/65/EL WEEE Direktiiv 2012/19/EL PPW Direktiiv 94/62/EU REACH MAARUS (EÜ) nr 1907/2006 ErP Direktiiv 2009/125/EÜ</p> <p>Nimi/ pealkiri : Richard Hsu / Quality Management Division Senior Manager Allikas : Kuupäev (pp/kk/aaaa) : 01/10/2014</p>  	<p>Environmental product declaration</p> <p>RoHS Directive 2011/65/EU WEEE Directive 2012/19/EU PPW Directive 94/62/CE REACH Regulation (EC) No 1907/2006 ErP Directive 2009/125/EC</p> <p>Name/ title : Richard Hsu / Quality Management Division Senior Manager Signature : Date (dd/mm/yyyy) : 01/10/2014</p>  	<p>Declaraciones Ambientales de Producto</p> <p>RoHS Directiva 2011/65/UE WEEE Directiva 2012/19/UE PPW Directiva 94/62/CE REACH REGLAMENTO (CE) nº 1907/2006 ErP Directiva 2009/125/CE</p> <p>Nombre/ título : Richard Hsu / Quality Management Division Senior Manager Firma : Fecha (aaaa/mm/dd) : 2014/10/01</p>  	<p>Profil environnemental de produit</p> <p>RoHS Directive 2011/65/UE WEEE Directive 2012/19/UE PPW Directive 94/62/CE REACH RÈGLEMENT (CE) Nº 1907/2006 ErP Directive 2009/125/CE</p> <p>Nom/ titre : Richard Hsu / Quality Management Division Senior Manager Signature : Date (dd/mm/yyyy) : 2014/10/01</p>  
Hrvatski (Croatian)	Italiano (Italian)	Latviešu valoda (Latvian)	Lietuvių kalba (Lithuanian)
<p>Deklaraciju o zbrinjavanju proizvoda</p> <p>RoHS Direktiva 2011/65/EU WEEE Direktiva 2012/19/EU PPW Direktiva 94/62/EZ REACH Uredbe (EZ) br. 1907/2006 ErP Direktiva 2009/125/EZ</p> <p>Ime/ nadim : Richard Hsu / Quality Management Division Senior Manager Podpis : Datum (dd/mm/yyyy) : 01/10/2014</p>  	<p>Dichiarazione ambientale di prodotto</p> <p>RoHS Direttiva 2011/65/UE WEEE Direttiva 2012/19/UE PPW Direttiva 94/62/CE REACH REGOLAMENTO (CE) n. 1907/2006 ErP Direttiva 2009/125/CE</p> <p>Nome/ titolo : Richard Hsu / Quality Management Division Senior Manager Firma : Data (aaaa/mm/gg) : 2014/10/01</p>  	<p>Produkta vides ietekmējuma deklarācija</p> <p>RoHS Direktīva 2011/65/ES WEEE Direktīva 2012/19/ES PPW Direktīva 94/62/EK REACH Regula (EK) Nr. 1907/2006 ErP Direktīva 2009/125/EK</p> <p>Nosaukums/ tāls : Richard Hsu / Quality Management Division Senior Manager Paraksts : Datums (dd/mm/yyyy) : 01/10/2014</p>  	<p>Aplinkosauginis gaminių deklaracija</p> <p>RoHS Direktyva 2011/65/ES WEEE Direktyva 2012/19/ES PPW Direktyva 94/62/WE REACH REGLAMENTAS (EB) Nr. 1907/2006 ErP Direktyva 2009/125/EB</p> <p>Varšius/ šiuks : Richard Hsu / Quality Management Division Senior Manager Parašas : Data (ddmmmmmm) : 01/10/2014</p>  
Magyar (Hungarian)	Malti (Maltese)	Nederlands (Dutch)	Polski (Polish)
<p>Környezetvédelmi terméknyilatkozat</p> <p>RoHS 2011/65/EU irányelve WEEE 2012/19/EU irányelve PPW 94/62/EK irányelve REACH 1907/2006/EK rendelet ErP 2009/125/EK irányelve</p> <p>Név/ cím : Richard Hsu / Quality Management Division Senior Manager Aláírás : Dátum (dd/mm/yyyy) : 2014/10/01</p>  	<p>Dikjarazzjoni Ambjentali dwar il-Prodott</p> <p>RoHS Direttiva 2011/65/UE WEEE Direttiva 2012/19/UE PPW Direttiva 94/62/CE REACH REGOLAMENTO (CE) NRU 1907/2006 ErP Direttiva 2009/125/CE</p> <p>Isem/ itlu : Richard Hsu / Quality Management Division Senior Manager Firma : Data (dd/mm/yyyy) : 2014/10/01</p>  	<p>Milieuproductverklaring</p> <p>RoHS Richtlijn 2011/65/EU WEEE Richtlijn 2012/19/EU PPW Richtlijn 94/62/EG REACH Verordening (EG) nr. 1907/2006 ErP Richtlijn 2009/125/EG</p> <p>Naam/ titel : Richard Hsu / Quality Management Division Senior Manager Handtekening : Datum (dd/mm/jaar) : 01/10/2014</p>  	<p>Deklarację środowiskową produktu</p> <p>RoHS Dyrektywa 2011/65/UE WEEE Dyrektywa 2012/19/UE PPW Dyrektywa 94/62/WE REACH Rozporządzenie (WE) nr. 1907/2006 ErP Dyrektywa 2009/125/WE</p> <p>Nazwisko/ tytuł : Richard Hsu / Quality Management Division Senior Manager Podpis : Data (ddmmmmmm) : 2014/10/01</p>  
Português (Portuguese)	Română (Romanian)	Slovenčina (Slovak)	Slovenščina (Slovene)
<p>Declaração ambiental do produto</p> <p>RoHS Diretiva 2011/65/UE WEEE Diretiva 2012/19/UE PPW Diretiva 94/62/CE REACH Regulamento (CE) nº 1907/2006 ErP Diretiva 2009/125/CE</p> <p>Nome/ título : Richard Hsu / Quality Management Division Senior Manager Assinatura : Data (dd/mm/aaaa) : 01/10/2014</p>  	<p>Declarație de mediu privind produsele</p> <p>RoHS Directiva 2011/65/UE WEEE Directiva 2012/19/UE PPW Directiva 94/62/CE REACH REGULAMENTUL (CE) NR. 1907/2006 ErP Directiva 2009/125/CE</p> <p>Numele/ titlu : Richard Hsu / Quality Management Division Senior Manager Semnatura : Data (dd/mm/yyyy) : 01/10/2014</p>  	<p>Vyhľadzenie o environmentálnom výrobku</p> <p>RoHS Smernica 2011/65/EU WEEE Smernica 2012/19/EU PPW Smernica 94/62/ES REACH Nariadenie (ES) č. 1907/2006 ErP Smernica 2009/125/ES</p> <p>Menlo/ titul : Richard Hsu / Quality Management Division Senior Manager Podpis : Datum (dd/mm/yyyy) : 01/10/2014</p>  	<p>Okoljsko deklaracija izdelka</p> <p>RoHS Direktiva 2011/65/EU WEEE Direktiva 2012/19/EU PPW Direktiva 94/62/ES REACH Uredba (ES) br. 1907/2006 ErP Direktiva 2009/125/ES</p> <p>Ime/ naziv : Richard Hsu / Quality Management Division Senior Manager Podpis : Datum (dd/mm/yyyy) : 01/10/2014</p>  
Suomi (Finnish)	Svenska (Swedish)	Ελληνικό (Greek)	Norsk (Norwegian)
<p>Standardin perustava ympäristötietustieto</p> <p>RoHS Direktiiv 2011/65/EU WEEE Direktiiv 2012/19/EU PPW Direktiiv 94/62/EY REACH ASETUS (EY) N:o 1907/2006 ErP Direktiiv 2009/125/EY</p> <p>Nimi/ osasto : Richard Hsu / Quality Management Division Senior Manager Ala kirjasto : Päivämäärä (pp/kk/vvvv) : 01/10/2014</p>  	<p>Miljöproduktdeklaration</p> <p>RoHS Direktiv 2011/65/EU WEEE Direktiv 2012/19/EU PPW Direktiv 94/62/EG REACH Förordning (EG) nr 1907/2006 ErP Direktiv 2009/125/EY</p> <p>Namn/ titel : Richard Hsu / Quality Management Division Senior Manager Namnteckning : Datum (dd/mm/åååå) : 01/10/2014</p>  	<p>Περιβαλλοντική δήλωση προϊόντος</p> <p>RoHS Οδηγία 2011/65/ΕΕ WEEE Οδηγία 2012/19/ΕΕ PPW Οδηγία 94/62/ΕΚ REACH Κ. ενσωμάτωση (ΕΚ) αριθ. 1907/2006 ErP Οδηγία 2009/125/ΕΚ</p> <p>Όνομα/ τίτλος : Richard Hsu / Quality Management Division Senior Manager Υπογραφή : Ημερομηνία (ηη/μμ/εεεε) : 01/10/2014</p>  	<p>Miljødeklarasjon</p> <p>RoHS Direktiv 2011/65/EU WEEE Direktiv 2012/19/EU PPW Direktiv 94/62/EF REACH Forordning (EF) nr. 1907/2006 ErP Direktiv 2009/125/EF</p> <p>Navn/ tittel : Richard Hsu / Quality Management Division Senior Manager Signatur : Dato (dd/mm/åååå) : 01/10/2014</p>  

台灣



以下訊息僅適用於產品具有無線功能且銷售至台灣地區

802.11b/802.11g 警語：

- 第十二條 經型式認證合格之低功率射頻電機，非經許可，公司，商號或使用者均不得擅自變更頻率、加大功率或變更原設計之特性及功能。
- 第十四條 低功率射頻電機之使用不得影響飛航安全及干擾合法通信；經發現有干擾現象時，應立即停用，並改善至無干擾時方得繼續使用。前項合法通信，指依電信法規定作業之無線電通信。低功率射頻電機須忍受合法通信或工業、科學及醫療用電波輻射性電機設備之干擾。

802.11a 警語：

無線傳輸設備 (UNII)

- 無線資訊傳輸設備忍受合法通信之干擾且不得干擾合法通信；如造成干擾，應立即停用，俟無干擾之虞，始得繼續使用。(4.7.6)
- 無線資訊傳輸設備的製造廠商應確保頻率穩定性，如依製造廠商使用手冊上所述正常操作，發射的信號應維持於操作頻帶中。(4.7.7)

NCC Statement:

1) 下列產品使用時建議應距離人體 20 cm

- 電磁波曝露量 MPE 標準值 (MPE) 1 mW/cm²，送測產品實值為 0.539 mW/cm² for NAP102。
- 電磁波曝露量 MPE 標準值 (MPE) 1 mW/cm²，送測產品實值為 0.756 mW/cm² for NAP203。
- 電磁波曝露量 MPE 標準值 (MPE) 1 mW/cm²，送測產品實值為 0.872 mW/cm² for NAP303。

2) 下列產品使用時建議應距離人體 30 cm

- 電磁波曝露量 MPE 標準值 (MPE) 1mW/cm²，送測產品實值為 0.539 mW/cm² for NAP353。

以下訊息僅適用於產品操作於 5.25-5.35 赫赫頻帶內並銷售至台灣地區

- 在 5.25-5.35 赫赫頻帶內操作之無線資訊傳輸設備，限於室內使用。

以下訊息僅適用於產品屬於專業安裝並銷售至台灣地區 (NAP353)

- 本器材須經專業工程人員安裝及設定，始得設置使用，且不得直接販售給一般消費者。





安全警告 - 為了您的安全，請先閱讀以下警告及指示：

- 請勿將此產品接近水、火焰或放置在高溫的環境。
- 避免設備接觸：
 - 任何液體 - 切勿讓設備接觸水、雨水、高濕度、污水腐蝕性的液體或其他水份。
 - 灰塵及污物 - 切勿接觸灰塵、污物、沙土、食物或其他不合適的材料。
- 雷雨天氣時，不要安裝，使用或維修此設備。有遭受電擊的風險。
- 切勿重摔或撞擊設備，並勿使用不正確的電源變壓器。
- 若接上不正確的電源變壓器會有爆炸的風險。
- 請勿隨意更換產品內的電池。
- 如果更換不正確之電池型式，會有爆炸的風險，請依製造商說明書處理使用過之電池。
- 請將廢電池丟棄在適當的電器或電子設備回收處。
- 請勿將設備解體。
- 請勿阻礙設備的散熱孔，空氣對流不足將造成設備損害。
- 請插在正確的電壓供給插座（如：北美 / 台灣電壓 110V AC，歐洲是 230V AC）。
- 假若電源變壓器或電源變壓器的纜線損壞，請從插座拔除，若您繼續插電使用，會有觸電死亡的風險。
- 請勿試圖修理電源變壓器或電源變壓器的纜線，若有毀損，請直接聯絡您購買的店家，購買一個新的電源變壓器。
- 請勿將此設備安裝於室外，此設備僅適合放置於室內。
- 請勿隨一般垃圾丟棄。
- 請參閱產品背貼上的設備額定功率。
- 請參考產品型錄或是彩盒上的作業溫度。
- 產品沒有斷電裝置或者採用電源線的插頭視為斷電裝置的一部分，以下警語將適用：
 - 對永久連接之設備，在設備外部須安裝可觸及之斷電裝置；
 - 對插接式之設備，插座必須接近安裝之地點而且是易於觸及的。

About the Symbols

Various symbols are used in this product to ensure correct usage, to prevent danger to the user and others, and to prevent property damage. The meaning of these symbols are described below. It is important that you read these descriptions thoroughly and fully understand the contents.

Explanation of the Symbols

SYMBOL	EXPLANATION
	Alternating current (AC): AC is an electric current in which the flow of electric charge periodically reverses direction.
	Direct current (DC): DC is the unidirectional flow or movement of electric charge carriers.
	Earth; ground: A wiring terminal intended for connection of a Protective Earthing Conductor.
	Class II equipment: The method of protection against electric shock in the case of class II equipment is either double insulation or reinforced insulation.

Viewing Certifications

Go to <http://www.zyxel.com> to view this product's documentation and certifications.

Zyxel Limited Warranty

Zyxel warrants to the original end user (purchaser) that this product is free from any defects in material or workmanship for a specific period (the Warranty Period) from the date of purchase. The Warranty Period varies by region. Check with your vendor and/or the authorized Zyxel local distributor for details about the Warranty Period of this product. During the warranty period, and upon proof of purchase, should the product have indications of failure due to faulty workmanship and/or materials, Zyxel will, at its discretion, repair or replace the defective products or components without charge for either parts or labor, and to whatever extent it shall deem necessary to restore the product or components to proper operating condition. Any replacement will consist of a new or re-manufactured functionally equivalent product of equal or higher value, and will be solely at the discretion of Zyxel. This warranty shall not apply if the product has been modified, misused, tampered with, damaged by an act of God, or subjected to abnormal working conditions.

Note

Repair or replacement, as provided under this warranty, is the exclusive remedy of the purchaser. This warranty is in lieu of all other warranties, express or implied, including any implied warranty of merchantability or fitness for a particular use or purpose. Zyxel shall in no event be held liable for indirect or consequential damages of any kind to the purchaser.

To obtain the services of this warranty, contact your vendor. You may also refer to the warranty policy for the region in which you bought the device at http://www.zyxel.com/web/support_warranty_info.php.

Registration

Register your product online to receive e-mail notices of firmware upgrades and information at www.zyxel.com.

Open Source Licenses

This product contains in part some free software distributed under GPL license terms and/or GPL like licenses. Open source licenses are provided with the firmware package. You can download the latest firmware at www.zyxel.com. If you cannot find it there, contact your vendor or Zyxel Technical Support at support@zyxel.com.tw.

To obtain the source code covered under those Licenses, please contact your vendor or Zyxel Technical Support at support@zyxel.com.tw.

Index

A

access [14](#)

C

certifications
 viewing [46](#)
channel [6](#)
configuration [6](#)
contact information [30](#)
cookies [14](#)
copyright [36](#)
customer support [30](#)

D

disclaimer [36](#)
dual radios [6](#)
dual-radio application [7](#)

E

ESSID [27](#)

F

FCC interference statement [36](#)
Firefox [14](#)

I

interference [6](#)

Internet Explorer [14](#)
IP Address [20](#)
 gateway IP address [20](#)
IP subnet [20](#)

J

Java
 permissions [14](#)
JavaScripts [14](#)

L

LEDs [8](#)
 Blinking [9, 10](#)
 Flashing [9, 10](#)
 Off [9, 10, 12](#)
logout
 Web Configurator [15](#)

M

management [6](#)
managing the device
 good habits [7](#)
message bar [17](#)
messages
 warning [17](#)

N

Netscape Navigator [14](#)

O

overview [6](#)

P

pop-up windows [14](#)
product registration [46](#)

R

radio [6](#)
registration
 product [46](#)
reset [29](#)
RESET button [29](#)
RF interference [6](#)

S

screen resolution [14](#)
status [18](#)
status bar [17](#)
 warning message popup [17](#)
supported browsers [14](#)

T

trademarks [36](#)

U

use [6](#)

V

Virtual Local Area Network [22](#)

VLAN [22](#)
 introduction [22](#)

W

warning message popup [17](#)
warranty [46](#)
 note [46](#)
Web Configurator [7, 14](#)
 access [14](#)
 requirements [14](#)
 supported browsers [14](#)
web configurator [6](#)
wireless channel [27](#)
wireless LAN [27](#)
wireless security [27](#)
WLAN interface [6](#)