

User's Guide

NWA30/50/55/90 Series

802.11a/b/g/n/ac/ax/be Access Point

Default Login Details

Management IP Address	http://DHCP-assigned IP OR http://192.168.1.2
User Name	admin
Password	See Zyxel Device label or 1234

Version 7.10-7.30 Edition 2, 5/2026

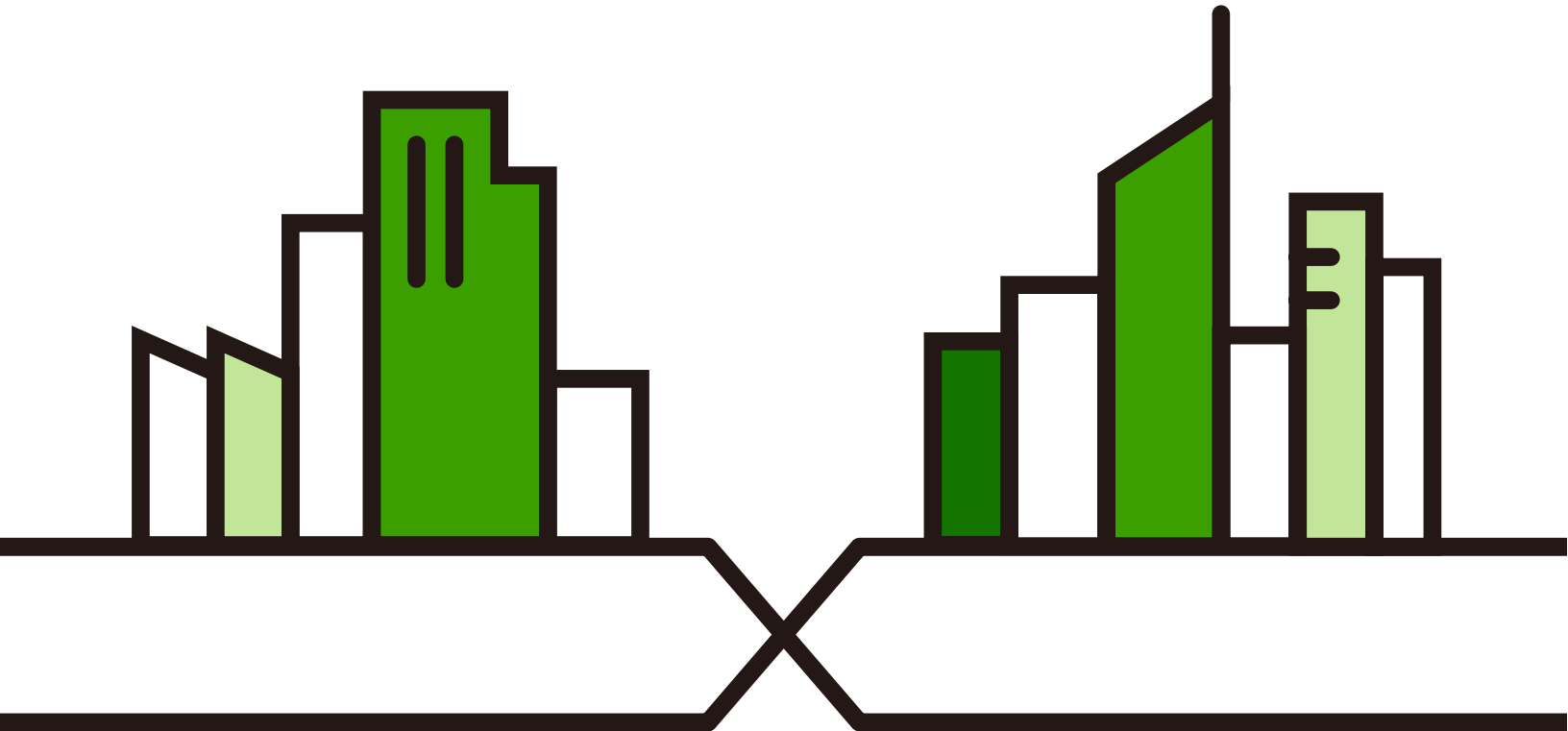

Document Conventions

Warnings and Notes

These are how warnings and notes are shown in this guide.

Warnings tell you about things that could harm you or your device.











Note: Notes tell you other important information (for example, other things you may need to configure or helpful tips) or recommendations.

Syntax Conventions

- All models in this series may be referred to as the "Zyxel Device" in this guide.
- Product labels, screen names, field labels and field choices are all in **bold** font.
- A right angle bracket (>) within a screen name denotes a mouse click. For example, **Configuration > Network > IP Setting** means you first click **Configuration** in the navigation panel, then the **Network** sub menu and finally the **IP Setting** tab to get to that screen.

Icons Used in Figures

Figures in this guide may use the following generic icons. The Zyxel Device icon is not an exact representation of your device.

Zyxel Device 	Router 	Switch 	Internet 
Server 	Desktop 	Laptop 	IP Phone 
Printer 	Smart TV. 		

Contents Overview

Introduction	12
AP Management	25
Hardware	35
Web Configurator	54
Standalone Configuration	65
Standalone Configuration	66
Dashboard	68
Setup Wizard	74
Getting Started	84
Monitor	136
Network	148
Wireless	154
User	169
AP Profile	176
WDS Profile	220
Certificates	222
System	238
Log and Report	256
File Manager	262
Legal and Regulatory	275
Diagnostics	276
LEDs	278
Reboot	281
Local Troubleshooting - Cloud Managed Mode	283
Cloud Managed Mode	284
Dashboard	286
Maintenance	291
Appendices and Troubleshooting	301
Troubleshooting	302

Table of Contents

Document Conventions	2
Contents Overview	3
Table of Contents.....	4
Chapter 1	
Introduction.....	12
1.1 Overview	12
1.2 Zyxel Device Product Feature Comparison	12
1.3 Zyxel Device Roles	17
1.3.1 Radio Frequency (RF) Monitor	20
1.4 Sample Feature Applications	21
1.4.1 MBSSID	21
1.4.2 Dual-Radio/Triple-Radio and BandFlex	22
Chapter 2	
AP Management.....	25
2.1 Management Mode	25
2.1.1 Standalone	25
2.1.2 Nebula Control Center	26
2.2 Switching Management Modes	28
2.3 Zyxel One Network (ZON) Utility	28
2.3.1 Requirements	28
2.3.2 Run the ZON Utility	29
2.4 Ways to Access the Zyxel Device	33
2.5 Good Habits for Managing the Zyxel Device	34
Chapter 3	
Hardware.....	35
3.1 Zyxel Device Models With Single LEDs	35
3.2 Zyxel Device LED	35
3.3 Ports	45
3.3.1 Ways to Reset a Zyxel Device without a Reset Button	50
3.4 PoE	52
Chapter 4	
Web Configurator.....	54
4.1 Overview	54
4.2 Accessing the Web Configurator	54

4.3 Navigating the Web Configurator	56
4.3.1 Title Bar	57
4.3.2 Navigation Panel	59
4.3.3 Standalone Mode Navigation Panel Menus	59
4.3.4 Cloud Managed Mode Navigation Panel Menus	61
4.3.5 Tables and Lists	62
Part I: Standalone Configuration	65
Chapter 5	
Standalone Configuration	66
5.1 Overview	66
5.2 Starting and Stopping the Zyxel Device	66
Chapter 6	
Dashboard	68
6.1 Overview	68
6.1.1 CPU Usage	71
6.1.2 Memory Usage	72
Chapter 7	
Setup Wizard	74
7.1 Accessing the Wizard	74
7.2 Using the Wizard	74
7.2.1 Step 1 Time Settings	74
7.2.2 Step 2 Uplink Connection	75
7.2.3 Step 3 SSID	76
7.2.4 Step 4 Radio	81
7.2.5 Step 5 Summary	82
Chapter 8	
Getting Started	84
8.1 Getting Started Overview	84
8.2 WiFi Network Setup	84
8.2.1 Select the Operation Mode	84
8.2.2 Set Up a WiFi Network in AP Mode	85
8.2.3 Set Up a WiFi Network in Root AP/Repeater Mode	87
8.2.4 Set Up General and Guest WiFi Networks on Both Radios	87
8.3 Limit Network Bandwidth for Each WiFi Client	92
8.4 Network Security	93
8.4.1 Change Security for a WiFi Network	93

8.4.2 RADIUS Server Setup	95
8.4.3 Set Up Rogue AP Detection	96
8.4.4 Set Up a Friendly AP List	98
8.4.5 Set Up a MAC Filter List	100
8.4.6 Restrict Users' Access to Specific Parts of Your Network	100
8.4.7 Test Your WiFi Access Restrictions	104
8.5 Device Settings	106
8.5.1 Change the Management IP Address	106
8.5.2 Change the System Name	107
8.5.3 Change the Login Password	108
8.6 Device Management Using Nebula	108
8.6.1 Create a Zyxel Account on the NCC Portal	109
8.6.2 Register your Zyxel Device on the NCC Portal	113
8.6.3 Create a Zyxel Account with the Zyxel Nebula Mobile App	118
8.6.4 Register your Zyxel Device with the Zyxel Nebula Mobile App	126
8.7 Device Maintenance	131
8.7.1 Upgrade the Firmware	131
8.7.2 Restore the Zyxel Device Configuration	131
8.8 Log and Report	132
8.8.1 Back Up Logs to a Remote Server	132
8.9 Remote Access to the Zyxel Device	134

Chapter 9

Monitor 136

9.1 Overview	136
9.1.1 What You Can Do in this Chapter	136
9.2 What You Need to Know	136
9.3 Network Status	136
9.3.1 Port Statistics Graph	138
9.4 Radio List	139
9.4.1 AP Mode Radio Information	140
9.5 Station List	142
9.6 WDS Link Info	143
9.7 Detected Device	144
9.8 View Log	145

Chapter 10

Network 148

10.1 Overview	148
10.1.1 What You Can Do in this Chapter	148
10.2 IP Setting	148
10.3 VLAN	151

Chapter 11	
Wireless	154
11.1 Overview	154
11.1.1 What You Can Do in this Chapter	154
11.1.2 What You Need to Know	154
11.2 AP Management	155
11.3 Rogue AP	163
11.3.1 Add/Edit Rogue/Friendly AP List	166
11.4 DCS	167
11.5 Technical Reference	167
Chapter 12	
User	169
12.1 Overview	169
12.1.1 What You Can Do in this Chapter	169
12.1.2 What You Need To Know	169
12.2 User Summary	170
12.2.1 Add or Edit User	170
12.3 Setting	172
12.3.1 Edit User Authentication Timeout Settings	174
Chapter 13	
AP Profile	176
13.1 Overview	176
13.1.1 What You Can Do in this Chapter	176
13.1.2 What You Need To Know	176
13.2 Radio	182
13.2.1 Add or Edit Radio Profile	183
13.3 SSID	191
13.3.1 SSID List	191
13.3.2 Add or Edit SSID Profile	193
13.4 Security List	196
13.4.1 Add or Edit Security Profile	198
13.4.2 Creating a Security Profile	214
13.5 MAC Filter List	215
13.5.1 Add or Edit MAC Filter Profile	216
13.6 Layer-2 Isolation List	217
13.6.1 Add or Edit Layer-2 Isolation Profile	219
Chapter 14	
WDS Profile	220
14.1 Overview	220
14.1.1 What You Can Do in this Chapter	220

14.2 WDS Profile	220
14.2.1 Add or Edit WDS Profile	221
Chapter 15	
Certificates.....	222
15.1 Overview	222
15.1.1 What You Can Do in this Chapter	222
15.1.2 What You Need to Know	222
15.1.3 Verifying a Certificate	224
15.2 My Certificates	225
15.2.1 Add My Certificates	226
15.2.2 Edit My Certificates	228
15.2.3 Import Certificates	231
15.3 Trusted Certificates	232
15.3.1 Edit Trusted Certificates	233
15.3.2 Import Trusted Certificates	236
15.4 Technical Reference	237
Chapter 16	
System.....	238
16.1 Overview	238
16.1.1 What You Can Do in this Chapter	238
16.2 Host Name	238
16.3 Power Mode	239
16.4 Date and Time	240
16.4.1 Pre-defined NTP Time Servers List	242
16.4.2 Time Server Synchronization	242
16.5 WWW Overview	243
16.5.1 Service Access Limitations	243
16.5.2 System Timeout	243
16.5.3 HTTPS	243
16.5.4 Configuring WWW Service Control	244
16.5.5 HTTPS Example	246
16.6 SSH	251
16.6.1 How SSH Works	251
16.6.2 SSH Implementation on the Zyxel Device	252
16.6.3 Requirements for Using SSH	253
16.6.4 Configuring SSH	253
16.6.5 Examples of Secure Telnet Using SSH	253
16.7 FTP	255
Chapter 17	
Log and Report.....	256

17.1 Overview	256
17.1.1 What You Can Do In this Chapter	256
17.2 Log Setting	256
17.2.1 Log Setting Screen	256
17.2.2 Edit Remote Server	257
17.2.3 Active Log Summary	259
Chapter 18	
File Manager	262
18.1 Overview	262
18.1.1 What You Can Do in this Chapter	262
18.1.2 What you Need to Know	262
18.2 Configuration File	265
18.2.1 Example of Configuration File Download Using FTP	268
18.3 Firmware Package	269
18.3.1 Example of Firmware Upload Using FTP	272
18.4 Shell Script	273
Chapter 19	
Legal and Regulatory	275
19.1 Overview	275
19.1.1 What You Can Do In this Chapter	275
19.2 Legal and Regulatory	275
Chapter 20	
Diagnostics	276
20.1 Overview	276
20.1.1 What You Can Do in this Chapter	276
20.2 Diagnostics	276
20.3 Remote Capture	277
Chapter 21	
LEDs	278
21.1 Overview	278
21.1.1 What You Can Do in this Chapter	278
21.2 Suppression Screen	278
21.3 Locator Screen	279
Chapter 22	
Reboot	281
22.1 Overview	281
22.1.1 What You Need To Know	281
22.2 Reboot	281

Part II: Local Troubleshooting - Cloud Managed Mode283

**Chapter 23
Cloud Managed Mode284**

23.1 Overview 284
 23.2 Local GUI Screens in Cloud Managed Mode 284

**Chapter 24
Dashboard286**

24.1 Overview 286
 24.2 Edit System Status 288
 24.2.1 Network 288
 24.2.2 NCC Discovery 289
 24.3 Edit Device Information 290

**Chapter 25
Maintenance 291**

25.1 Overview 291
 25.1.1 What You Can Do in this Chapter 291
 25.2 Firmware Package 291
 25.3 Shell Script 293
 25.4 Legal and Regulatory 296
 25.5 Diagnostics 296
 25.6 Remote Capture 297
 25.7 View Log 298
 25.8 Reboot 299

Part III: Appendices and Troubleshooting 301

**Chapter 26
Troubleshooting302**

26.1 Overview 302
 26.2 Power, Hardware Connections, and LEDs 302
 26.3 Zyxel Device Management, Access, and Login 304
 26.4 Internet Access 309
 26.5 WiFi Network 310
 26.6 Resetting the Zyxel Device 312
 26.7 Getting More Troubleshooting Help 313

Appendix A Zyxel Account Authentication 314

Appendix B Importing a Certificate 342

Appendix C IPv6 355

Appendix D Customer Support 364

Appendix E Legal Information 369

Index.....384

CHAPTER 1

Introduction

1.1 Overview

This User's Guide covers the models listed below:

WiFi 6 Models

- NWA50AX
- NWA90AX
- NWA55AXE
- NWA50AX PRO
- NWA55AX PRO
- NWA90AX PRO

WiFi 7 Models

- NWA30BE
- NWA50BE
- NWA55BE
- NWA90BE
- NWA50BE PRO
- NWA90BE PRO

The Zyxel Device can be managed in one of the following methods: remote management through Nebula Control Center (NCC) or local management in Standalone Mode. The Zyxel Device runs in standalone mode by default, but it is recommended to use NCC management if it is available for your device. For more information about Access Point (AP) management, see [Management Mode](#).

Use the Zyxel Device to set up a WiFi network with other IEEE 802.11a/b/g/n/ac/ax/be compatible devices in either 2.4 GHz, 5 GHz, and 6 GHz networks or all three at the same time.

To see if your Zyxel Device supports 6 GHz, please refer to [Zyxel Device Product Feature Comparison](#).

When two or more APs are interconnected, this network is called a Wireless Distribution System (WDS). See [Zyxel Device Roles](#) for more information on root and repeater APs and how to set them up.

The screens you see in the web configurator may be different depending on the Zyxel Device model you're using.

1.2 Zyxel Device Product Feature Comparison

The following table lists the features of the Zyxel Device.

Table 1 WiFi 6 Models Comparison Table

FEATURES	NWA50AX	NWA90AX	NWA55AXE
Supported WiFi Standards	IEEE 802.11a IEEE802.11b IEEE 802.11g IEEE 802.11n IEEE 802.11ac IEEE802.11ax	IEEE 802.11a IEEE802.11b IEEE 802.11g IEEE 802.11n IEEE 802.11ac IEEE802.11ax	IEEE 802.11a IEEE802.11b IEEE 802.11g IEEE 802.11n IEEE 802.11ac IEEE802.11ax
Multi-Link Operation (MLO)	No	No	No

Table 1 WiFi 6 Models Comparison Table (continued)

FEATURES	NWA50AX	NWA90AX	NWA55AXE
Supported Frequency Bands	2.4 GHz 5 GHz	2.4 GHz 5 GHz	2.4 GHz 5 GHz
Supported Channel Width	2.4G: 20 / 40 MHz 5G: 20 / 40 / 80 MHz	2.4G: 20 / 40 MHz 5G: 20 / 40 / 80 MHz	2.4G: 20 / 40 MHz 5G: 20 / 40 / 80 MHz
Available Security Modes	None / Enhanced-open / WEP / WPA2-MIX-Personal / WPA3-Personal	None / Enhanced-open / WEP / WPA2-MIX / WPA3-Personal & Enterprise	None / Enhanced-open / WEP / WPA2-MIX / WPA3-Personal & Enterprise
Number of SSID Profiles	64	64	64
Number of WiFi Radios	2	2	2
Security Profile Radius Settings	No	Yes	Yes
Security Profile Enterprise Authentication Settings	No	Yes	Yes
Rogue AP Detection	Yes	Yes	Yes
WDS (Wireless Distribution System) - Root AP & Repeater Modes	Yes	Yes	Yes
Wireless Bridge	No	No	Yes
Layer-2 Isolation	Yes	Yes	Yes
Supported PoE Standards	IEEE 802.3at	IEEE 802.3at	IEEE 802.3at
Power Detection	No	No	No
External Antennas	No	No	Yes
Internal Antennas	Yes	Yes	No
Console Port	4-Pin Serial	4-Pin Serial	No
Reset button	Yes	Yes	No
LED Locator	Yes	Yes	No
LED Suppression	Yes	Yes	Yes
APC (AP Controller) Discovery	No	No	No
NCC Discovery	Yes	Yes	Yes
802.11r Fast Roaming Support	Yes	Yes	Yes
802.11k/v Assisted Roaming	Yes	Yes	Yes
Ethernet Storm Control	No	No	No
Grounding	No	No	No
Power Jack	Yes	Yes	No
Maximum number of log messages	512 event logs		
Latest Firmware Version Supported	7.10	7.10	7.10

Table 2 WiFi 6 PRO Models Comparison Table

FEATURES	NWA50AX PRO	NWA55AX RPO	NWA90AX PRO
Supported WiFi Standards	IEEE 802.11a IEEE802.11b IEEE 802.11g IEEE 802.11n IEEE 802.11ac IEEE802.11ax	IEEE 802.11a IEEE802.11b IEEE 802.11g IEEE 802.11n IEEE 802.11ac IEEE802.11ax	IEEE 802.11a IEEE802.11b IEEE 802.11g IEEE 802.11n IEEE 802.11ac IEEE802.11ax
Multi-Link Operation (MLO)	No	No	No

Table 2 WiFi 6 PRO Models Comparison Table (continued)

FEATURES	NWA50AX PRO	NWA55AX RPO	NWA90AX PRO
Supported Frequency Bands	2.4 GHz 5 GHz	2.4 GHz 5 GHz	2.4 GHz 5 GHz
Supported Channel Width	2.4G: 20 / 40 MHz 5G: 20 / 40 / 80 / 160 MHz	2.4G: 20 / 40 MHz 5G: 20 / 40 / 80 / 160 MHz	2.4G: 20 / 40 MHz 5G: 20 / 40 / 80 / 160 MHz
Available Security Modes	None / Enhanced-open / WEP / WPA2-MIX-Personal / WPA3-Personal	None / Enhanced-open / WEP / WPA2-MIX-Personal / WPA3-Personal	None / Enhanced-open / WEP / WPA2-MIX / WPA3 -Personal & Enterprise
Number of SSID Profiles	64	64	64
Number of WiFi Radios	2	2	2
Security Profile Radius Settings	No	No	Yes
Security Profile Enterprise Authentication Settings	No	No	Yes
Rogue AP Detection	Yes	Yes	Yes
WDS (Wireless Distribution System) - Root AP & Repeater Modes	Yes	Yes	Yes
Wireless Bridge	No	Yes	No
Layer-2 Isolation	Yes	Yes	Yes
Supported PoE Standards	IEEE 802.3at	IEEE 802.3at	IEEE 802.3at
Power Detection	No	No	No
External Antennas	No	No	No
Internal Antennas	Yes	Yes	Yes
Console Port	4-Pin Serial	No	4-Pin Serial
Reset Button	Yes	Yes	Yes
LED Locator	Yes	Yes	Yes
LED Suppression	Yes	Yes	Yes
APC (AP Controller) Discovery	No	No	No
NCC Discovery	Yes	Yes	Yes
802.11r Fast Roaming Support	Yes	Yes	Yes
802.11k/v Assisted Roaming	Yes	Yes	Yes
Ethernet Storm Control	No	No	No
Grounding	No	No	No
Power Jack	Yes	Yes	Yes
Maximum number of log messages	512 event logs		
Latest Firmware Version Supported	7.10	7.10	7.10

Table 3 WiFi 7 Models Comparison Table (Part 1)

FEATURES	NWA30BE	NWA50BE	NWA55BE	NWA90BE
Supported WiFi Standards	IEEE 802.11a IEEE802.11b IEEE 802.11g IEEE 802.11n IEEE 802.11ac IEEE802.11ax IEEE802.11be	IEEE 802.11a IEEE802.11b IEEE 802.11g IEEE 802.11n IEEE 802.11ac IEEE802.11ax IEEE802.11be	IEEE 802.11a IEEE802.11b IEEE 802.11g IEEE 802.11n IEEE 802.11ac IEEE802.11ax IEEE802.11be	IEEE 802.11a IEEE802.11b IEEE 802.11g IEEE 802.11n IEEE 802.11ac IEEE802.11ax IEEE802.11be
Multi-Link Operation (MLO)	Yes	Yes	Yes	Yes

Table 3 WiFi 7 Models Comparison Table (Part 1) (continued)

FEATURES	NWA30BE	NWA50BE	NWA55BE	NWA90BE
Supported Frequency Bands	2.4 GHz 5 GHz	2.4 GHz 5 GHz	2.4 GHz 5 GHz	2.4 GHz 5 GHz
Supported Channel Width	2.4G: 20 / 40 MHz 5G: 20 / 40 / 80 / 160 / 240 MHz	2.4G: 20 / 40 MHz 5G: 20 / 40 / 80 / 160 / 240 MHz	2.4G: 20 / 40 MHz 5G: 20 / 40 / 80 / 160 / 240 MHz	2.4G: 20 / 40 MHz 5G: 20 / 40 / 80 / 160 / 240 MHz
Available Security Modes	None / Enhanced- open / WEP / WPA2-MIX- Personal / WPA3 - Personal	None / Enhanced- open / WEP / WPA2-MIX- Personal / WPA3 - Personal	None / Enhanced- open / WEP / WPA2-MIX / WPA3 -Personal & Enterprise	None / Enhanced- open / WEP / WPA2-MIX / WPA3 -Personal & Enterprise
Number of SSID Profiles	64	64	64	64
Number of WiFi Radios	2	2	2	2
Security Profile Radius Settings	No	No	Yes	Yes
Security Profile Enterprise Authentication Settings	No	No	Yes	Yes
Rogue AP Detection	Yes	Yes	Yes	Yes
WDS (Wireless Distribution System) - Root AP & Repeater Modes	Yes	Yes	Yes	Yes
Wireless Bridge	Yes	Yes	Yes	Yes
Layer-2 Isolation	Yes	Yes	Yes	Yes
Supported PoE Standards	No	IEEE 802.3at	IEEE 802.3at	IEEE 802.3at
Power Detection	No	No	No	No
External Antennas	Yes	No	Yes	No
Internal Antennas	No	Yes	No	Yes
Console Port	No	4-Pin Serial	No	4-Pin Serial
Reset button	Yes	Yes	Yes	Yes
LED Locator	Yes	Yes	Yes	Yes
LED Suppression	Yes	Yes	Yes	Yes
APC (AP Controller) Discovery	No	No	No	No
NCC Discovery	Yes	Yes	Yes	Yes
802.11r Fast Roaming Support	Yes	Yes	Yes	Yes
802.11k/v Assisted Roaming	Yes	Yes	Yes	Yes
Ethernet Storm Control	No	No	No	No
Grounding	No	No	No	No
Power Jack	Yes	Yes	No	Yes
Maximum number of log messages	512 event logs	512 event logs	512 event logs	512 event logs
Latest Firmware Version Supported	7.30	7.30	7.30	7.30

Table 4 WiFi 7 Models Comparison Table (Part 2)

FEATURES	NWA50BE PRO	NWA90BE PRO
Supported WiFi Standards	IEEE 802.11a IEEE802.11b IEEE 802.11g IEEE 802.11n IEEE 802.11ac IEEE802.11ax IEEE802.11be	IEEE 802.11a IEEE802.11b IEEE 802.11g IEEE 802.11n IEEE 802.11ac IEEE802.11ax IEEE802.11be
BandFlex (5 GHz/6 GHz)	Yes	Yes
Multi-Link Operation (MLO)	Yes	Yes
Supported Frequency Bands	2.4 GHz 5 GHz 6 GHz	2.4 GHz 5 GHz 6 GHz
Supported Channel Width	2.4G: 20 / 40 MHz 5G: 20 / 40 / 80 / 160 / 240 MHz 6G: 80 / 160 / 320 MHz	2.4G: 20 / 40 MHz 5G: 20 / 40 / 80 / 160 / 240 MHz 6G: 80 / 160 / 320 MHz
Available Security Modes	None / Enhanced-open / WEP / WPA2-MIX- Personal / WPA3 - Personal	None / Enhanced-open / WEP / WPA2-MIX / WPA3 -Personal & Enterprise
Number of SSID Profiles	64	64
Number of WiFi Radios	2	2
Security Profile Radius Settings	No	Yes
Security Profile Enterprise Authentication Settings	No	Yes
Rogue AP Detection	Yes	Yes
WDS (Wireless Distribution System) - Root AP & Repeater Modes	Yes	Yes
Wireless Bridge	Yes	Yes
Layer-2 Isolation	Yes	Yes
Supported PoE Standards	IEEE 802.3at	IEEE 802.3at
Power Detection	No	No
External Antennas	No	No
Internal Antennas	Yes	Yes
Console Port	4-Pin Serial	4-Pin Serial
Reset button	Yes	Yes
LED Locator	Yes	Yes
LED Suppression	Yes	Yes
APC (AP Controller) Discovery	No	No
NCC Discovery	Yes	Yes
802.11r Fast Roaming Support	Yes	Yes
802.11k/v Assisted Roaming	Yes	Yes
Ethernet Storm Control	No	No
Grounding	No	No
Power Jack	Yes	Yes
Maximum number of log messages	512 event logs	512 event logs
Latest Firmware Version Supported	7.30	7.30

1.3 Zyxel Device Roles

This section describes some of the different roles that your Zyxel Device can take up within a network. Not all roles are supported by all models (see [Zyxel Device Product Feature Comparison](#)). The Zyxel Device can serve as a:

- Access Point (AP) – This is used to allow WiFi clients to connect to the Internet.
- Radio Frequency (RF) monitor – If your Zyxel Device supports rogue APs detection, it can serve as an RF monitor and searches for rogue APs to help eliminate network threats. An RF monitor can simultaneously act as an AP.
- Root AP – A root AP connects to the gateway or switch through a wired Ethernet connection and has wireless repeaters connected to it to extend its range.
- WiFi Repeater – A WiFi repeater wirelessly connects to a root AP and extends the network's wireless range. A wireless repeater can also be a wireless bridge that connects to a root AP and extends the network to wired client devices.

If a client (**D**) tries to set up his own AP (**R**) with weak security settings, the network becomes exposed to threats. The RF monitor (**M**) scans the area to detect all APs, which can help the network administrator discover these rogue APs and remove them.

Figure 1 Zyxel Device Application in a Network

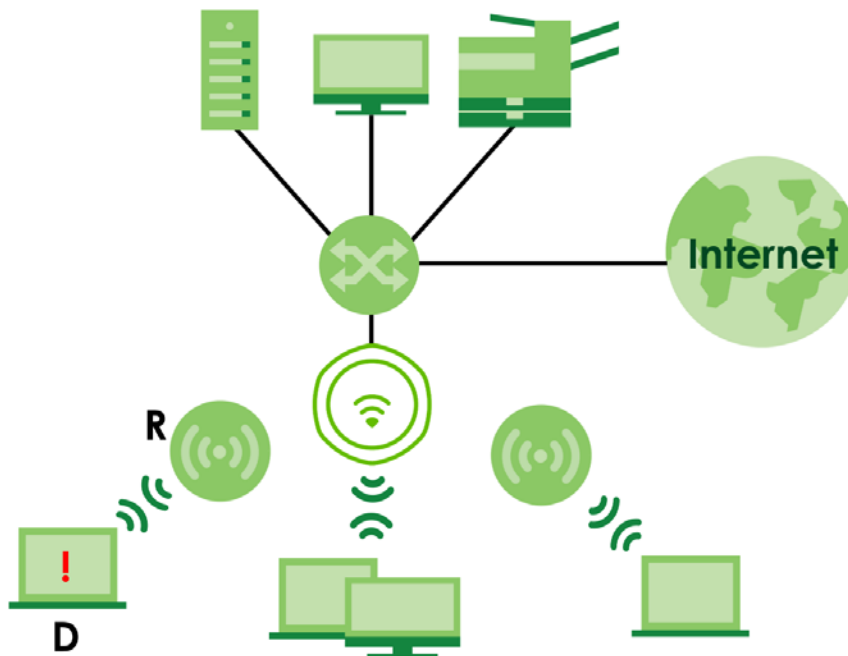

Wireless Distribution System (WDS)

Wireless Distribution System (WDS) is a network system that allows you to distribute the network to areas that require Internet connections. You can extend your network to unreachable areas with wireless repeaters.

The following figure shows you how to create a secure WDS with two wireless repeaters. The root AP (**Y**) is connected to a network with Internet access and has wireless repeaters (**X** and **Z**) connected to it to expand the WiFi network's range. Clients (**A** and **B**) can access the wired network through the wireless repeaters (**X** and **Z**) and/or root AP.

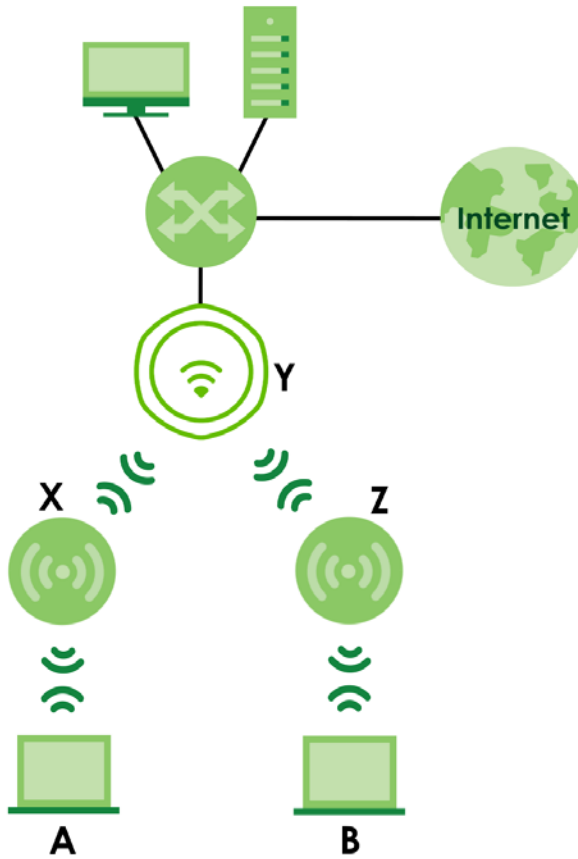
Figure 2 Wireless Distribution System Network Example

The Zyxel Device can also serve as a wireless bridge in Repeater mode. A wireless bridge connects two wired networks through a wireless connection. When the Zyxel Device is connected to a root AP, enable wireless bridge to allow traffic through the Ethernet port on the Zyxel Device to a wired network. Check [Zyxel Device Product Feature Comparison](#) for models that support wireless bridge.

The following figure shows an example of a WDS with a repeater acting as a wireless bridge. The root AP (**X**) is connected to a network with Internet access. The wireless repeater (**Y**) is connected to the root AP (**X**) to expand the network. Clients (**A** and **B**) are connected to the wireless repeater through the switch/gateway/router (**G**). They can access the network with the extended wired network the wireless bridge (wireless repeater) provides.

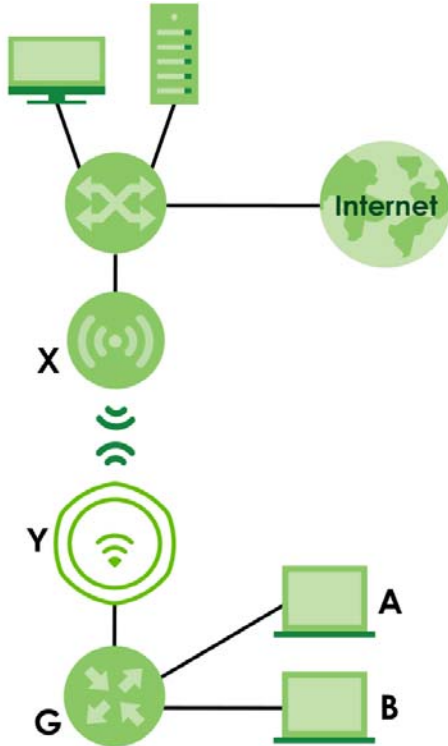
Figure 3 Wireless Bridge Network Example

Access Point (AP)

The Zyxel Device can receive connections from WiFi clients and pass their data traffic through to the Zyxel Device to be managed (or subsequently passed on to an upstream gateway for managing).

In **AP Mode**, the Zyxel Device is connected to a broadband modem with Internet access and provides a WiFi network for users to use their notebooks or computers to wirelessly access the Internet.

Figure 4 AP Mode Application

Root AP

The Zyxel Device acts as an AP and also supports the WiFi connections with other APs (in repeater mode) to form a WDS to extend its WiFi network.

In **Root AP** mode, you can have multiple SSIDs active for regular WiFi connections and one SSID (WDS SSID) for the connection with a repeater. WiFi clients can use either SSID to associate with the Zyxel Device in Root AP mode. A repeater must use the repeater SSID to connect to the Zyxel Device in **Root AP** mode. See [Overview](#) for more details.

When the Zyxel Device is in **Root AP** mode, repeater security between the Zyxel Device and other repeaters is independent of the security between the WiFi clients and the AP or repeater. When repeater

security is enabled, both APs and repeaters must use the same pre-shared key. See [AP Management](#) and [WDS Profile](#) for more details.

Unless specified, the term “security settings” refers to the traffic between the WiFi clients and the AP. At the time of writing, repeater security is compatible with the Zyxel Device only.

WiFi Repeater

The Zyxel Device can establish a WiFi connection with other APs (in either **Root AP** or **Repeater** mode) to form a WDS.

Using **Repeater** mode, your Zyxel Device can extend the range of the WLAN. In the figure below, the Zyxel Device in Repeater mode (**Z**) has a WiFi connection to the Zyxel Device in **Root AP** mode (**X**) which is connected to a wired network and also has a WiFi connection to another Zyxel Device in **Repeater** mode (**Y**) at the same time. **Z** acts as a repeater that forwards traffic between associated WiFi clients and the wired LAN. **Y** acts as a WiFi bridge (repeater with WDS wireless bridging enabled) that forwards traffic between wired clients and the wired LAN. Clients **A** and **B** access the AP and the wired network behind the AP through repeaters **Z** and **Y**.

Figure 5 Repeater Application

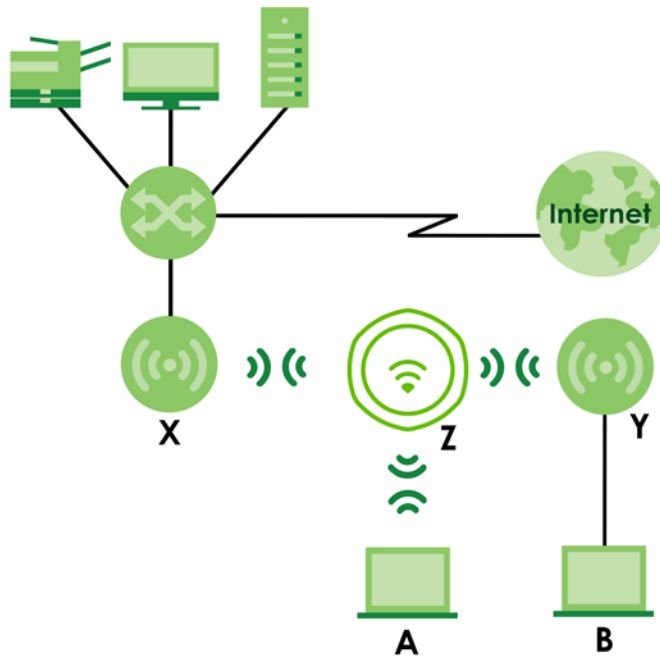

When the Zyxel Device is in **Repeater** mode, repeater security between the Zyxel Device and other repeater is independent of the security between the WiFi clients and the AP or repeater. When repeater security is enabled, both APs and repeaters must use the same pre-shared key. See [AP Management](#) and [WDS Profile](#) for more details.

For NCC managed devices, you only need to enable **AP Smart Mesh** to automatically create WiFi links between APs. See the NCC User’s Guide for more details.

1.3.1 Radio Frequency (RF) Monitor

The Zyxel Device supports **Rogue AP Detection** (see [Rogue AP](#)). **Rogue AP Detection** allows the Zyxel

Device to be set to work as an RF monitor to discover nearby Access Points. The information it obtains from other APs is used to tag possible rogue APs and friendly APs. The Zyxel Device can still work as an AP while it scans the environment for wireless signals.

1.4 Sample Feature Applications

This section describes some possible scenarios and topologies that you can set up using your Zyxel Device.

1.4.1 MBSSID

A Basic Service Set (BSS) is the set of devices forming a single WiFi network (usually an access point and one or more WiFi clients). The Service Set Identifier (SSID) is the name of a BSS. In Multiple BSS (MBSSID) mode, the Zyxel Device provides multiple virtual APs, each forming its own BSS and using its own individual SSID profile.

You can configure multiple SSID profiles, and have all of them active at any one time.

You can assign different wireless and security settings to each SSID profile. This allows you to compartmentalize groups of users, set varying access privileges, and prioritize network traffic to and from certain BSSs.

To the WiFi clients in the network, each SSID appears to be a different access point. As in any WiFi network, clients can associate only with the SSIDs for which they have the correct security settings.

For example, you might want to set up a WiFi network in your office where Internet telephony (VoIP) users have priority. You also want a regular WiFi network for standard users, as well as a 'guest' WiFi network for visitors. In the following figure, **VoIP_SSID** users have QoS priority, **SSID01** is the WiFi network for standard users, and **Guest_SSID** is the WiFi network for guest users. In this example, the guest user is forbidden access to the wired Local Area Network (LAN) behind the AP and can access only the Internet.

Figure 6 Multiple BSSs

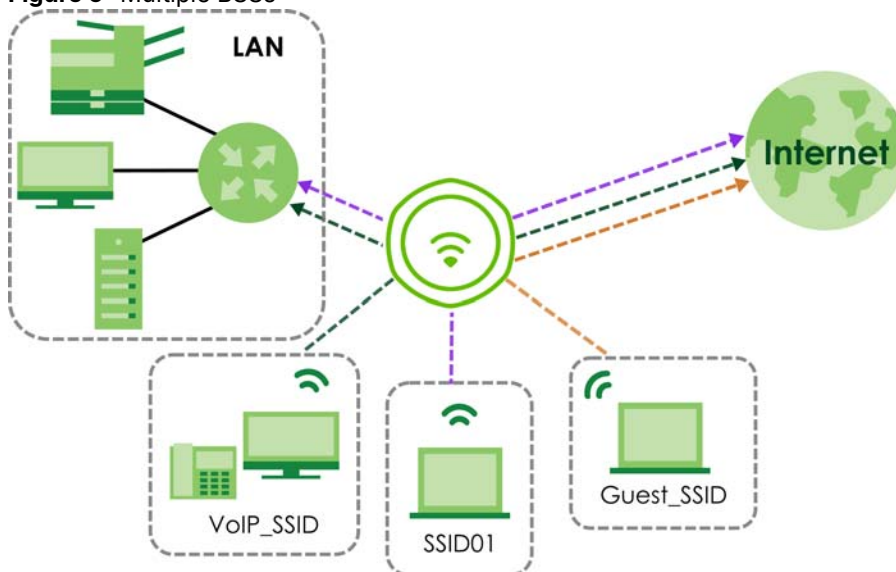

1.4.2 Dual-Radio/Triple-Radio and BandFlex

The Zyxel Device models are equipped with two or even three WiFi radios. The Zyxel Device uses the WiFi radios to transmit WiFi signals. This means you can configure different WiFi networks on the 2.4G/5G/6G bands to operate simultaneously.

BandFlex allows you to select the frequency bands operating on the radios by configuration. A frequency band is a range of frequency divided into channels which carry the WiFi signals for data transmission. If your Zyxel Device supports BandFlex, you can configure the second radio on the Zyxel Device to use the 5 GHz or 6 GHz bands, while the first radio is always set to use the 2.4 GHz band. The 6 GHz band provides less coverage but has the highest amount of channels among the three frequency bands. Use the 6 GHz band for the most congestion-free transmission if your client devices supports WiFi 6E (see [Zyxel Device Product Feature Comparison](#)).

Note: Due to each country's regulations on frequency band usage, the available radio bands (2.4 GHz, 5 GHz, and 6 GHz) may differ by countries or markets the Zyxel Device products are sold to.

Note: A different channel should be configured for each WLAN interface to reduce the effects of radio interference.

You could use the 2.4 GHz band for regular Internet surfing and downloading while using the 5 GHz or 6 GHz band for time sensitive traffic like high-definition video, music, and gaming.

See [Zyxel Device Product Feature Comparison](#) for the supported number of radios, frequency bands, and see if your Zyxel Device supports BandFlex.

Figure 7 Dual-Radio Application

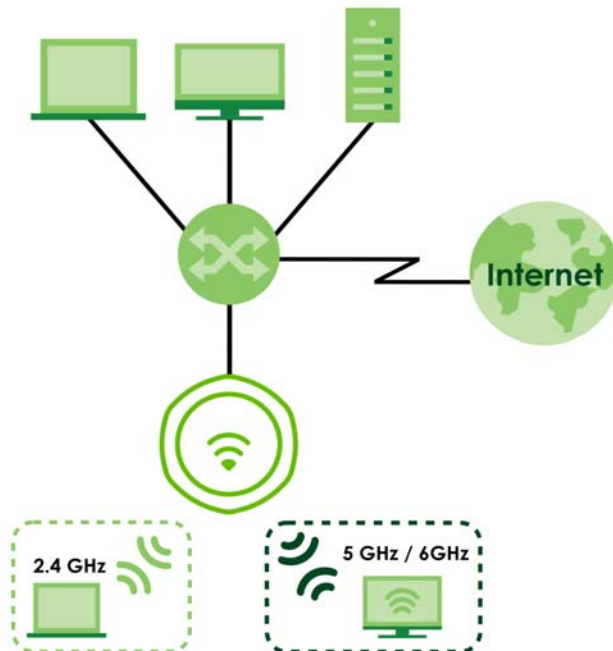
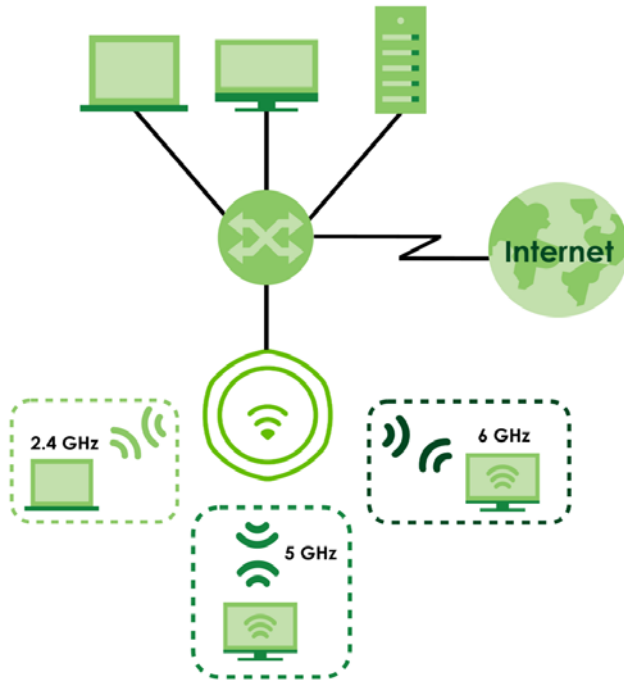
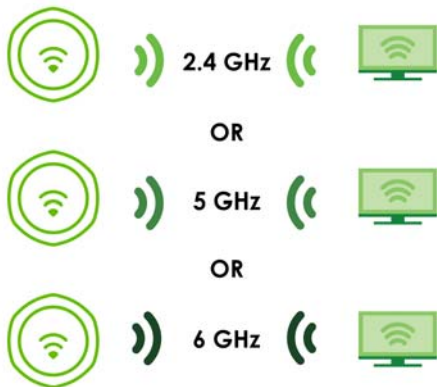

Figure 8 Triple-Radio Application

Multi-Link Operation (MLO)

An AP can support multiple frequency bands (2.4 GHz, 5 GHz and 6 GHz), but a WiFi client can only connect to the AP using one of these frequency bands. The other frequency bands are unused. The client's data transmission speed depends on the frequency band they are connected to.

Figure 9 Without Multi-Link Operation

WiFi 7 MLO allows a WiFi client to connect to the AP using multiple frequency bands simultaneously. This increases speed and improves reliability of the WiFi connection. MLO makes WiFi 7 ideal for streaming 4K/8K videos, using augmented reality (AR), virtual reality (VR) applications and playing online games.

To use MLO, both the AP and the WiFi client have to support MLO.

Note: Not all Zyxel Device models support MLO feature. See the comparison table in [Zyxel Device Product Feature Comparison](#). You can only set up MLO through NCC or the CLI. See NCC User's Guide or the Command Reference Guide for more information.

Figure 10 Multi-Link Operation Example

Preamble Puncturing

In WiFi 6 and earlier, any interference would cause the entire WiFi channel to become unavailable. In the figure below, if part of the WiFi channel (**B**) experiences interference, the rest of the WiFi channel (**C**) becomes unavailable.

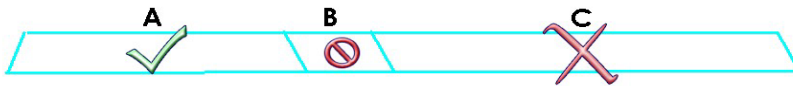
Figure 11 Without Preamble Puncturing

WiFi 7 preamble puncturing allows you to block the specific portion of the channel that is experiencing interference while continuing to use the rest of the WiFi channel. In the figure below, if part of the WiFi channel (**B**) experiences interference, the rest of the WiFi channel (**C**) is still available.

Figure 12 Preamble Puncturing Example

CHAPTER 2

AP Management

2.1 Management Mode

The Zyxel Device is a unified AP and can be managed by NCC, or work as a standalone device. We recommend you use NCC to manage multiple APs (see the NCC User's Guide).

The following table shows the default IP addresses and firmware upload methods for different management modes.

Table 5 Zyxel Device Management Mode Comparison

MANAGEMENT MODE	DEFAULT IP ADDRESS	UPDATE FIRMWARE THROUGH
Nebula Control Center	Dynamic	NCC Portal / Built-in Web Configurator
Standalone	Dynamic or Static (192.168.1.2)	Built-in Web Configurator

When the Zyxel Device is in standalone mode and connects to a DHCP server, it uses the IP address assigned by the DHCP server. Otherwise, the Zyxel Device uses the default static management IP address (192.168.1.2).

When the Zyxel Device is managed by the NCC, it acts as a DHCP client and obtains an IP address from NCC. You can configure the Zyxel Device using the web configurator when the Zyxel Device is not connected to NCC. Refer to [Switching Management Modes](#) if you need to change the Zyxel Device's management mode.

2.1.1 Standalone

When working in standalone mode, the Zyxel Device is configured with its built-in Web Configurator (preferred) or CLI. You can only connect to and set up one Zyxel Device at a time in this mode.

Figure 13 Web Configurator in Standalone Mode

The screenshot displays the Zyxel NWA50BE PRO Web Configurator interface in Standalone Mode. The top navigation bar includes the Zyxel logo, the device model 'NWA50BE PRO', and user information 'Welcome admin'. Navigation icons for Wizard, Help, Community, Site Map, CLI, and Logout are present, along with the Nebula logo.

The main dashboard area is titled 'DASHBOARD' and contains several widget sections:

- Device Information:**
 - System Name: [NWA50BE-PRO](#)
 - System Location: [n/a](#)
 - Model Name: NWA50BE PRO
 - Serial Number:
 - MAC Address Range:
 - Firmware Version: [V7.20\(0\) / 2025-06-16 05:48:26](#)
 - Last Firmware Upgrade Status: Success
 - Last Firmware Upgrade: 2025-05-27 07:03:13
- System Status:**
 - System Uptime: 7 days 04:05:21
 - Current Date/Time: [2025-06-03 / 11:09:35 UTC+00:00](#)
 - Current Login User: admin (unlimited / 00:30:00)
 - Boot Status: Firmware update OK
 - Management Mode: standalone
 - Power Mode: Full
- System Resources:**
 - CPU Usage: 2%
 - Memory Usage: 37%
 - Flash Usage: 1%
- Interface Status Summary:**

Name	Status	VID	IP Addr/Netmask	IP Assi...	Action
lan	1000M...	1	0.0.0.0 / 0.0.0.0	DHCP ...	Renew
- AP Information:**
 - All Sensed Device:
 - Un-Classified AP: 0
 - Rogue AP: 0
 - Friendly AP: 0
- Ethernet Neighbor:**

Local ...	Model...	Syste...	FW Ve...	Port(D...	IP	MAC
1 (lan)	N/A	N/A	N/A	N/A	N/A	N/A
- WLAN Interface Status Summary:**

Status	MAC Address	Radio	Band	OP ...	Cha...	Station
🔴		1	2.4G	AP [...	1 (20...	0
🟡		2	5G	AP [...	40 (8...	0
- WDS Downlink Status:**

MAC Address	Radio	Ch...	SSID	Security Mode	Link ...
-------------	-------	-------	------	---------------	----------
- WDS Uplink Status:**

MAC Address	Radio	Ch...	SSID	Security Mode	Link ...
-------------	-------	-------	------	---------------	----------

See [Standalone Configuration](#) for detailed information about the standalone Web Configurator screens.

2.1.2 Nebula Control Center

In this mode, which is also called cloud managed mode, you can manage and monitor the Zyxel Device through the Zyxel Nebula cloud-based network management system. This means you can manage devices remotely without the need of connecting to each device directly. It offers many features to better manage and monitor not just the Zyxel Device, but your network as a whole, including supported switches and gateways. Your network can also be managed through your smartphone using the Nebula Mobile app. See [Cloud Managed Mode](#) for an example NCC managed network topology.

Figure 14 NCC Dashboard

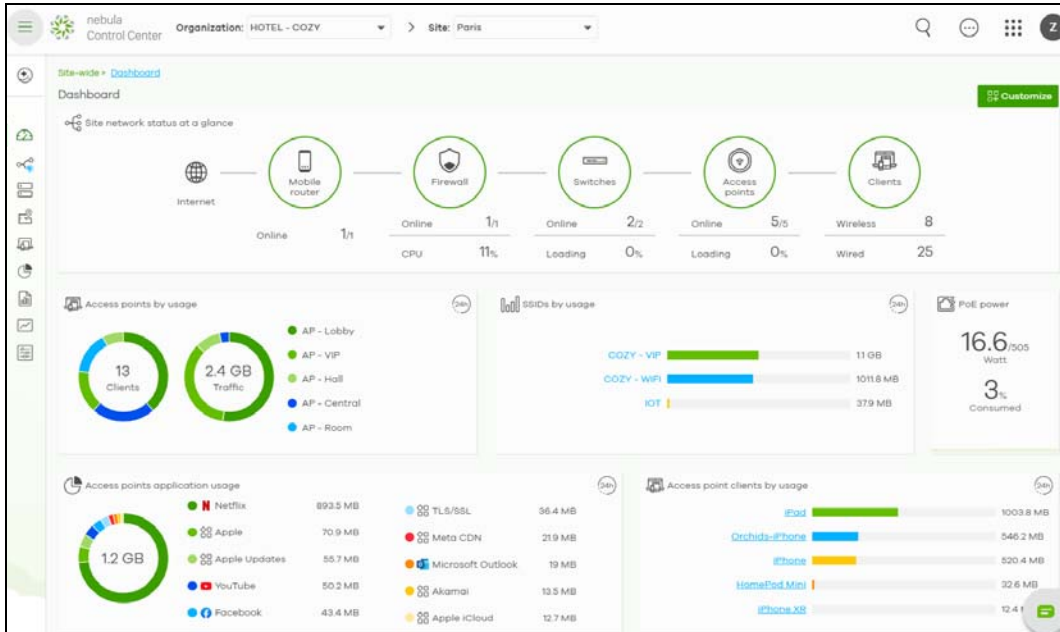

Each Zyxel Device must belong to a site which must be in an organization. You can configure each Zyxel Device on its own or configure a set of Zyxel Devices together in a site. You can also monitor groups of sites in organizations.

Table 6 Sites and Organizations

Organization	Organization	Organization	Organization
Site A	Site A	Site B	Site B
Device A-1	Device A-2	Device B-1	Device B-2

You can use the **Topology** in NCC which graphically presents your device and network statistics. It shows an overview of your network topology, as shown in the following figure. See the NCC User's Guide for how to configure Nebula managed devices.

Figure 15 NCC Topology

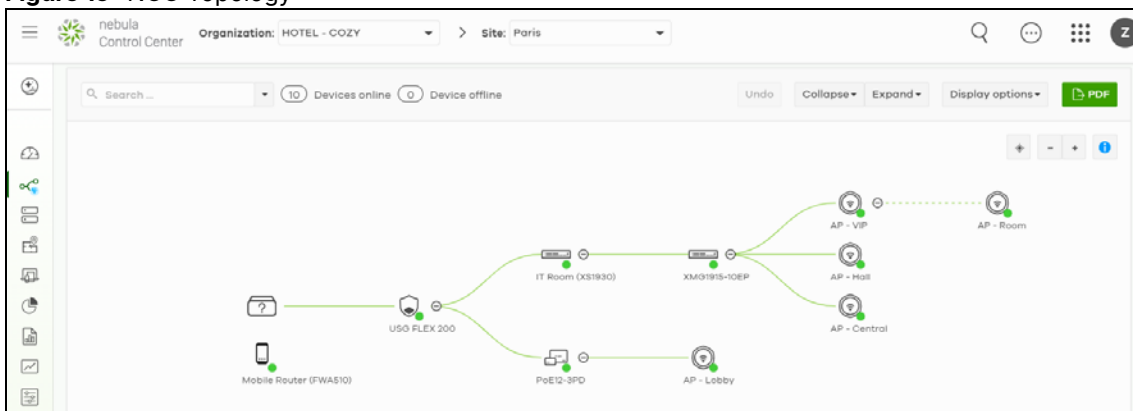

Note: Make sure your network firewall allows TCP ports 443, 4335, and 6667 as well as UDP port 123 so the Zyxel Device can connect to and sync with the NCC.

2.2 Switching Management Modes

This section shows you how to switch the Zyxel Device's management mode between standalone and cloud managed mode.

To change the Zyxel Device management mode, use the **Reset** button to restore the default configuration (see [Resetting the Zyxel Device](#)). Alternatively, you need to check NCC for the Zyxel Device's IP address and use FTP to upload the default configuration file at `conf/system-default.conf` to the Zyxel Device and reboot it.

Standalone-to-NCC

Register the Zyxel Device on the NCC website and then turn on the Zyxel Device. The NCC manages the Zyxel Device automatically when it is discovered. Settings on the Zyxel Device will be overwritten with what you have configured on the NCC website.

NCC-to-Standalone

Back up your configurations first, then unregister the Zyxel Device from NCC. Press the **Reset** button. The Zyxel Device will reset to factory defaults. See [Accessing the Web Configurator](#) to log in to the Web Configurator and select standalone mode.

2.3 Zyxel One Network (ZON) Utility

ZON Utility is a program designed to help you deploy and manage a network more efficiently. It detects devices automatically and allows you to do basic settings on devices in the network without having to be near it.

The ZON Utility issues requests through Zyxel Discovery Protocol (ZDP) and in response to the query, the device responds back with basic information including IP address, firmware version, location, system and model name in the same broadcast domain. The information is then displayed in the ZON Utility screen and you can perform tasks like basic configuration of the devices and batch firmware upgrade in it. You can download the ZON Utility at www.zyxel.com and install it on your computer (Windows operating system).

2.3.1 Requirements

Before installing the ZON Utility on your computer, please make sure it meets the requirements listed below.

Operating System

At the time of writing, the ZON Utility is compatible with:

- Windows 7 (both 32-bit / 64-bit versions)
- Windows 8 (both 32-bit / 64-bit versions)
- Windows 8.1 (both 32-bit / 64-bit versions)
- Windows 10 (both 32-bit / 64-bit versions)
- Windows 11 (64-bit version)

Note: To check for your Windows operating system version, right-click on **My Computer > Properties** on your computer. You should see this information in the **General** tab.

Note: It is suggested that you install Npcap, the packet capture library for Windows operating systems, and remove WinPcap or any other installed packet capture tools before you install the ZON utility.

Hardware

Here are the minimum hardware requirements to use the ZON Utility on your computer.

- Core i3 processor
- 2 GB RAM
- 100 MB free hard disk
- WXGA (Wide XGA 1280x800)

2.3.2 Run the ZON Utility

- 1 Double-click the ZON Utility to run it.
- 2 The first time you run the ZON Utility, you will see if your device and firmware version support the ZON Utility. Click the **OK** button to close this screen.

Figure 16 Supported Devices and Versions

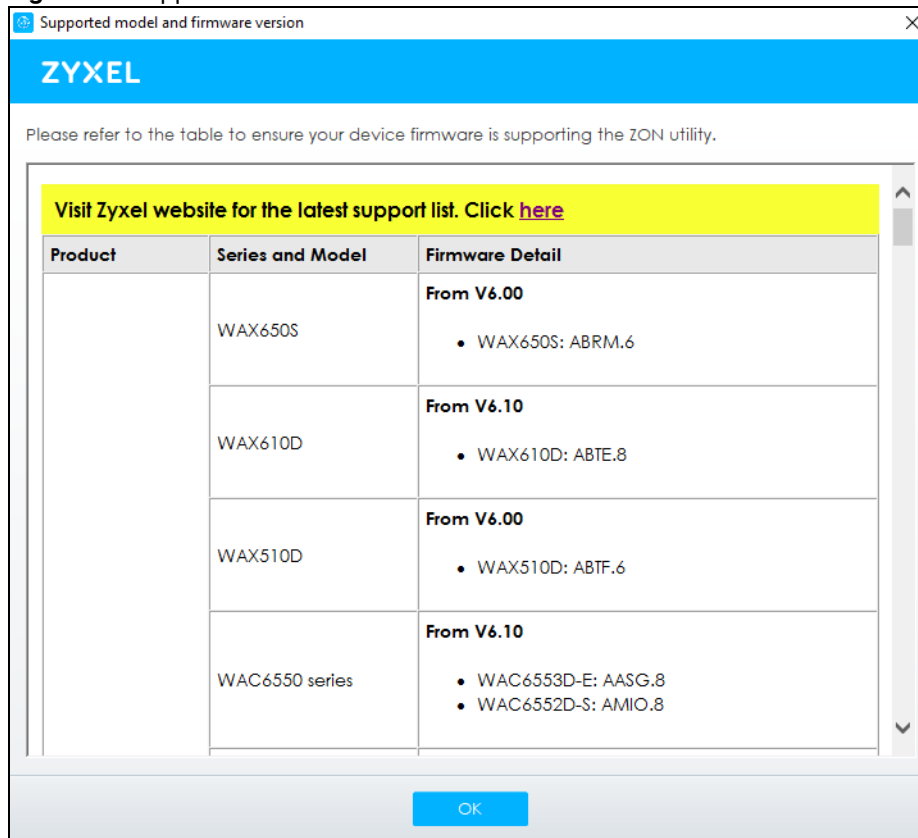

If you want to check the supported models and firmware versions later, you can click the **Show information about ZON** icon in the upper right hand corner of the screen. Then select the **Supported model and firmware version** link. If your device is not listed here, see the device release notes for ZON Utility support. The release notes are in the firmware zip file on the Zyxel web site.

Figure 17 ZON Utility Screen

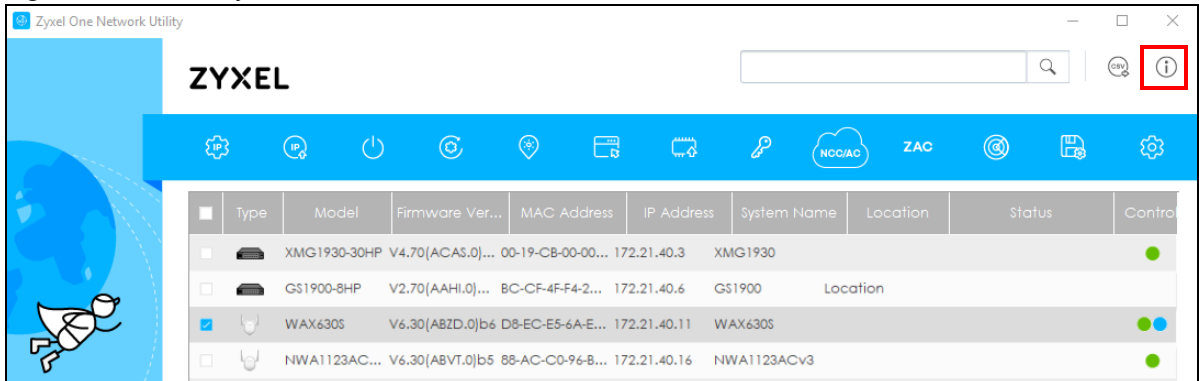

- 3 Select a network adapter to which your supported devices are connected.

Figure 18 Network Adapter

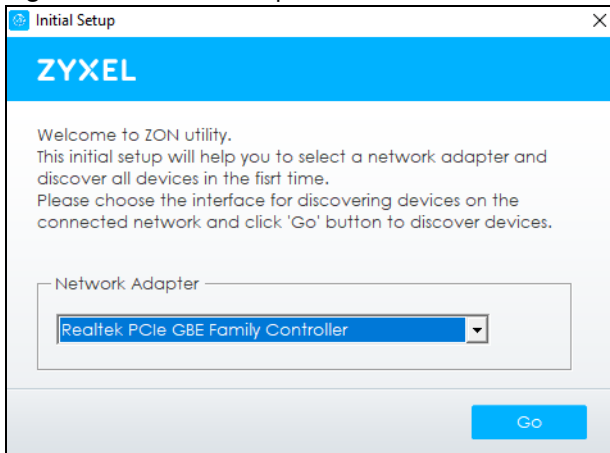

- 4 Click the **Go** button for the ZON Utility to discover all supported devices in your network.

Figure 19 Discovery

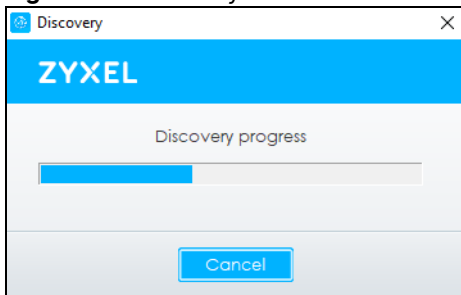

- 5 The ZON Utility screen shows the devices discovered.

Figure 20 ZON Utility Screen

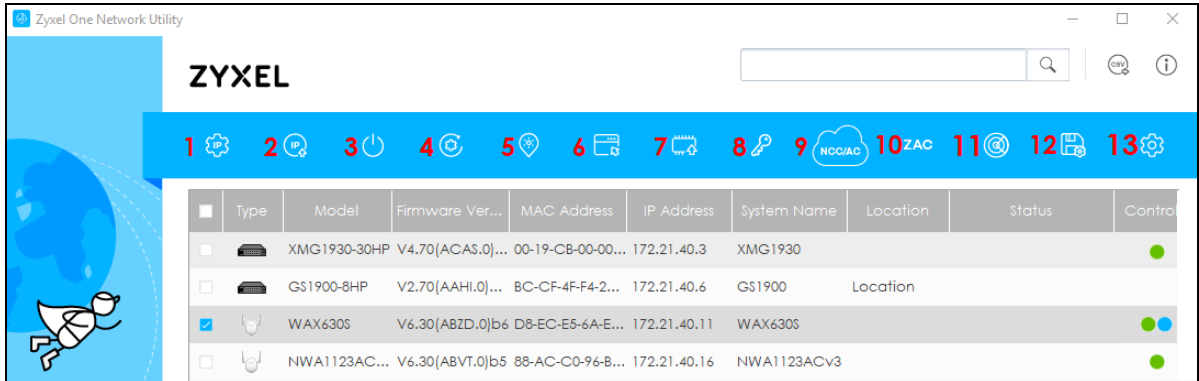

- 6 Select a device and then use the icons to perform actions. Some functions may not be available for your devices.

Note: You must know the selected device admin password before taking actions on the device using the ZON Utility icons. If the selected device is being managed or has been managed by the NCC, check **Local credentials** in the NCC's **Site-wide > Configure > Site settings** screen for the selected device's current password.

Figure 21 Password Prompt

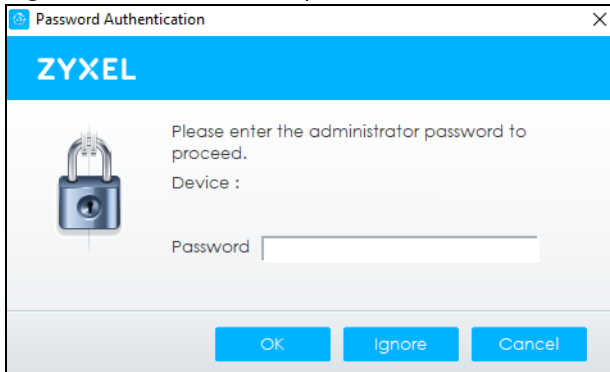

The following table describes the icons numbered from left to right in the ZON Utility screen.

Table 7 ZON Utility Icons

ICON	DESCRIPTION
1 IP Configuration	Change the selected device's IP address.
2 Renew IP Address	Update a DHCP-assigned dynamic IP address.
3 Reboot Device	Use this icon to restart the selected device(s). This may be useful when troubleshooting or upgrading new firmware.
4 Reset Configuration to Default	Use this icon to reload the factory-default configuration file. This means that you will lose all previous configurations.
5 Locator LED	Use this icon to locate the selected device by causing its Locator LED to blink.
6 Web GUI	Use this to access the selected device Web Configurator from your browser. You will need a username and password to log in.

Table 7 ZON Utility Icons (continued)

ICON	DESCRIPTION
7 Firmware Upgrade	Use this icon to upgrade new firmware to selected device(s) of the same model. Make sure you have downloaded the firmware from the Zyxel website to your computer and unzipped it in advance. The ZON only supports a standalone mode AP for the firmware upgrade, it does not support to upgrade the firmware for a managed mode AP.
8 Change Password	Use this icon to change the admin password of the selected device. You must know the current admin password before changing to a new one.
9 Configure Controller Discovery and NCC Discovery	The option is available if the selected device supports AP controller (APC) discovery or Nebula Control Center (NCC) discovery. You must have Internet access to use this feature. Use this icon on the selected device to enable or disable the: <ul style="list-style-type: none"> • AP controller (APC) discovery feature • Nebula Control Center (NCC) discovery feature If the feature is enabled, the selected device will try to connect to the APC or NCC. If the selected device has successfully connected to an APC, it will change to the controller managed mode. If the selected device has successfully connected to the NCC and is registered on the NCC, it will change to the cloud managed mode.
10 ZAC	Use this icon to run the Zyxel AP Configurator of the selected AP.
11 Clear and Rescan	Use this icon to clear the list and discover all devices on the connected network again.
12 Save Configuration	Use this icon to save configuration changes to permanent memory on a selected device.
13 Settings	Use this icon to select a network adapter for the computer on which the ZON utility is installed, and the utility language.

The following table describes the fields in the ZON Utility main screen.

Table 8 ZON Utility Fields

LABEL	DESCRIPTION
Type	This field displays an icon of the kind of device discovered.
Model	This field displays the model name of the discovered device.
Firmware Version	This field displays the firmware version of the discovered device.
MAC Address	This field displays the MAC address of the discovered device.
IP Address	This field displays the IP address of an internal interface on the discovered device that first received an ZDP discovery request from the ZON utility.
System Name	This field displays the system name of the discovered device.
Location	This field displays where the discovered device is.
Status	This field displays whether changes to the discovered device have been done successfully. As the Zyxel Device does not support IP Configuration , Renew IP address and Flash Locator LED , this field displays "Update failed", "Not support Renew IP address" and "Not support Flash Locator LED" respectively.

Table 8 ZON Utility Fields (continued)

LABEL	DESCRIPTION
Controller Discovery	<p>This field displays if the discovered device supports the:</p> <ul style="list-style-type: none"> • AP controller (APC) discovery feature. • Nebula Control Center (NCC) discovery feature. <p>If the feature is enabled, the selected device will try to connect to the APC or NCC. If the selected device has successfully connected to an AP controller, it will change to the AP controller managed mode. If the selected device has successfully connected to the NCC and is registered on the NCC, it will change to the cloud managed mode.</p> <ul style="list-style-type: none"> ● means NCC discovery is enabled. ● means controller discovery is enabled. ● means discovery is disabled.
Serial Number	Enter the admin password of the discovered device to display its serial number.
Hardware Version	This field displays the hardware version of the discovered device.
IPv6 Address	This field displays the IPv6 address of an internal interface on the discovered device that first received an ZDP discovery request from the ZON utility.

2.4 Ways to Access the Zyxel Device

You can use the following ways to configure the Zyxel Device.

Web Configurator

The Web Configurator allows easy Zyxel Device setup and management using an Internet browser. If your Zyxel Device is managed by the NCC, use this only for troubleshooting if you cannot connect to the Internet. This User's Guide provides information about the Web Configurator.

NCC

This is the primary means by which you manage the Zyxel Device in cloud managed mode (NCC). With the NCC, you can remotely manage and monitor the Zyxel Device through a cloud-based network management system. See the NCC User's Guide for more information.

ZON Utility

Zyxel One Network (ZON) Utility is a utility tool that assists you to set up and maintain network devices in a simple and efficient way. You can download the ZON Utility at www.zyxel.com and install it on your computer (Windows operating system). For more information on ZON Utility see [Zyxel One Network \(ZON\) Utility](#).

Command-Line Interface (CLI)

The CLI allows you to use text-based commands to configure the Zyxel Device. You can access it using remote management (SSH) or through the console port. See the Command Reference Guide for more information.

File Transfer Protocol (FTP)

This protocol can be used for firmware upgrades and configuration backup and restore.

2.5 Good Habits for Managing the Zyxel Device

Do the following things regularly to make the Zyxel Device more secure and to manage it more effectively.

- Change the password often. Use a password that is not easy to guess and that consists of different types of characters, such as numbers and letters.
- Write down the password and put it in a safe place.
- Back up the configuration (and make sure you know how to restore it). Restoring an earlier working configuration may be useful if the Zyxel Device becomes unstable or even crashes. If you forget your password, you will have to reset the Zyxel Device to its factory default settings. If you backed up an earlier configuration file, you will not have to totally re-configure the Zyxel Device; you can simply restore your last configuration.

CHAPTER 3

Hardware

See the Quick Start Guide for hardware installation and connections.

3.1 Zyxel Device Models With Single LEDs

The LEDs of some Zyxel Device models can be controlled by using the suppression feature such that the LEDs stay lit (ON) or OFF after the Zyxel Device is ready. Some Zyxel Device models also have Locator LED which allows you to see the actual location of the Zyxel Device among several devices in the network. See [Zyxel Device Product Feature Comparison](#) to check which models support these features. Refer to [Overview](#) for the LED **Suppression** and **Locator** menus in standalone mode.

3.2 Zyxel Device LED

The LED of the Zyxel Device can be controlled by using the suppression feature such that the LED stays lit (ON) or OFF after the Zyxel Device is ready. Refer to [Overview](#) for the LED **Suppression** and **Locator** menus in standalone mode.

802.11ax (WiFi 6) Dual- Radio PoE Access Point

- [NWA50AX, NWA90AX, NWA50AX PRO, and NWA90AX PRO](#)

802.11ax (WiFi 6) Dual- Radio Outdoor PoE Access Point

- [NWA55AXE](#)

802.11be (WiFi 7) Dual- Radio Desktop Access Point

- [NWA55AX PRO](#)

802.11be (WiFi 7) Dual- Radio PoE Access Point

- [NWA50BE, NWA90BE, NWA50BE PRO, and NWA90BE PRO](#)

802.11be (WiFi 7) Dual- Radio Outdoor PoE Access Point

- [NWA55BE](#)

NWA50AX, NWA90AX, NWA50AX PRO, and NWA90AX PRO

Figure 22 NWA50AX, NWA90AX, NWA50AX PRO, and NWA90AX PRO LEDs



The following are the LED descriptions for the Zyxel Device.

Table 9 Zyxel Device LEDs











COLOR	STATUS	DESCRIPTION	
	Amber Green	Blinks between amber and green alternately (300 milliseconds interval).	The Zyxel Device is booting up.
	Amber Green	Blinks between amber and green alternately (1 second interval).	The Zyxel Device is discovering the NCC.
	Amber Green	Blinks between amber and green alternately 3 times and then turns solid green for 3 seconds.	The Zyxel Device is managed by the NCC but fails to connect with NCC, and is reconnecting with the NCC.
	Green	Slow Blinking (On for 1 second, Off for 1 second)	The wireless module of the Zyxel Device is disabled or fails, the Zyxel Device is using default WiFi settings, and/or the Zyxel Device is configured to be managed by the NCC but is not yet registered with the NCC.
	Green	Steady On	The Zyxel Device is ready for use, the Zyxel Device's wireless interface is activated, and WiFi clients are connected to the Zyxel Device.
	Bright Blue	Steady On	The Zyxel Device's wireless interface is activated, but there are no WiFi clients connected.

Table 9 Zyxel Device LEDs (continued)

COLOR		STATUS	DESCRIPTION
	White	Slow Blinking (On for 100 ms per second)	Locator LED is on. It switches off automatically after the configured amount of time (1-60 min). Default duration is 10 minutes. Note: The color of the white LED may have slight differences (for example, very light purple) on different models.
	Blue	Slow Blinking (Blink for 1 time, Off for 1 second)	The Zyxel Device is performing a Channel Availability Check (CAC) with Dynamic Frequency Selection (DFS) to monitor a channel for radar signals.
	Red	On	The Zyxel Device failed to boot up or is experiencing system failure.
		Fast Blinking (On for 50 milliseconds, Off for 50 milliseconds)	The Zyxel Device is undergoing firmware upgrade.
		Slow Blinking (Blink for 3 times, Off for 3 seconds)	The uplink of the Zyxel Device is disconnected.

NWA55AXE

Figure 23 NWA55AXE



Note: The NWA55AXE does not have LEDs. Please refer to the LAN port indicators. The light turns on when connected, and blinks during data transmission.

NWA55AX PRO

Figure 24 NWA55AX PRO LED

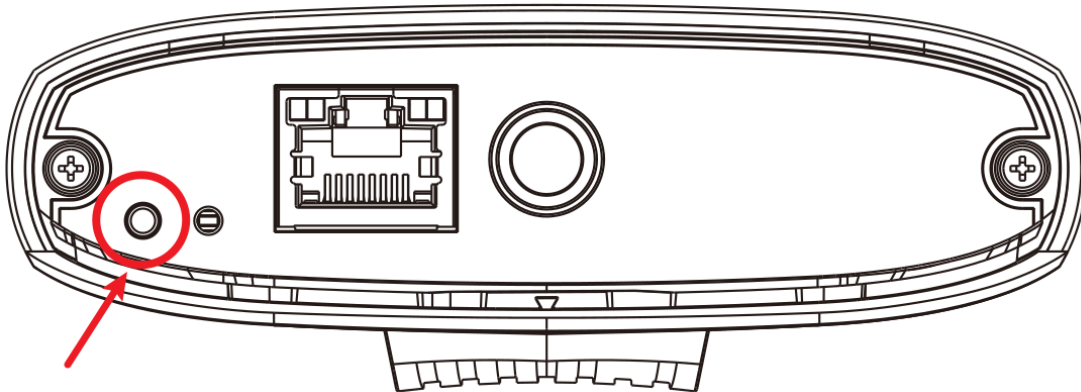

Remove the cover to view the System LED. The System LED is located under the cover of the Zyxel Device, and next to the Reset button.

The following are the System LED indicator descriptions for the Zyxel Device.

Table 10 Zyxel Device LED













COLOR	STATUS	DESCRIPTION
	Amber Green	Blinks between amber and green alternately (300 milliseconds interval).
	Amber Green	Blinks between amber and green alternately (1 second interval).
	Amber Green	Blinks between amber and green alternately 3 times and then turns solid green for 3 seconds.
	Green	Slow Blinking (On for 1 second, Off for 1 second)
	Green	Steady On
	Bright Blue	Steady On
	White	Slow Blinking (On for 100 ms per second)
	White	Locator LED is on. It switches off automatically after the configured amount of time (1-60 min). Default duration is 10 minutes. Note: The color of the white LED may have slight differences (for example, very light purple) on different models.
	Blue	Slow Blinking (Blink for 1 time, Off for 1 second)
	Blue	The Zyxel Device is performing a Channel Availability Check (CAC) with Dynamic Frequency Selection (DFS) to monitor a channel for radar signals.

Table 10 Zyxel Device LED (continued)

COLOR		STATUS	DESCRIPTION
	Red	On	The Zyxel Device failed to boot up or is experiencing system failure.
		Fast Blinking (On for 50 milliseconds, Off for 50 milliseconds)	The Zyxel Device is undergoing firmware upgrade.
		Slow Blinking (Blink for 3 times, Off for 3 seconds)	The uplink of the Zyxel Device is disconnected.

NWA30BE

Figure 25 NWA30BE LED



Figure 26 LED of the RJ45 Port on NWA30BE

The following are the system LED indicator descriptions for the Zyxel Device.

Table 11 Zyxel Device System LED











COLOR	STATUS	DESCRIPTION
	Amber Green	Blinks between amber and green alternately (300 milliseconds interval).
	Amber Green	Blinks between amber and green alternately (1 second interval).
	Amber Green	Blinks between amber and green alternately 3 times and then turns solid green for 3 seconds.
	Green	Slow Blinking (On for 1 second, Off for 1 second)
	Green	Steady On
	Bright Blue	Steady On
	White	Slow Blinking (On for 100 ms per second)
		Locator LED is on. It switches off automatically after the configured amount of time (1-60 min). Default duration is 10 minutes. Note: The color of the white LED may have slight differences (for example, very light purple) on different models.

Table 11 Zyxel Device System LED (continued)

COLOR		STATUS	DESCRIPTION
	Blue	Slow Blinking (Blink for 1 time, Off for 1 second)	The Zyxel Device is performing a Channel Availability Check (CAC) with Dynamic Frequency Selection (DFS) to monitor a channel for radar signals.
	Red	On	The Zyxel Device failed to boot up or is experiencing system failure.
		Fast Blinking (On for 50 milliseconds, Off for 50 milliseconds)	The Zyxel Device is undergoing firmware upgrade.
		Slow Blinking (Blink for 3 times, Off for 3 seconds)	The uplink of the Zyxel Device is disconnected.

NWA50BE, NWA90BE, NWA50BE PRO, and NWA90BE PRO

The System LED is located on the upper cover of the Zyxel Device.

Figure 27 NWA50BE, NWA90BE, NWA50BE PRO, and NWA90BE PRO LED



The following are the system LED indicator descriptions for the Zyxel Device.

Table 12 Zyxel Device System LED









COLOR		STATUS	DESCRIPTION
	Amber	Blinks between amber and green alternately (300 milliseconds interval).	The Zyxel Device is booting up.
	Green		

Table 12 Zyxel Device System LED (continued)

COLOR		STATUS	DESCRIPTION
	Amber	Blinks between amber and green alternately (1 second interval).	The Zyxel Device is discovering the NCC.
	Green		
	Amber	Blinks between amber and green alternately 3 times and then turns solid green for 3 seconds.	The Zyxel Device is managed by the NCC but fails to connect with NCC, and is reconnecting with the NCC.
	Green		
	Green	Slow Blinking (On for 1 second, Off for 1 second)	The wireless module of the Zyxel Device is disabled or fails, the Zyxel Device is using default WiFi settings, and/or the Zyxel Device is configured to be managed by the NCC but is not yet registered with the NCC.
	Green	Steady On	The Zyxel Device is ready for use, the Zyxel Device's wireless interface is activated, and WiFi clients are connected to the Zyxel Device.
	Bright Blue	Steady On	The Zyxel Device's wireless interface is activated, but there are no WiFi clients connected.
	White	Slow Blinking (On for 100 ms per second)	Locator LED is on. It switches off automatically after the configured amount of time (1-60 min). Default duration is 10 minutes. Note: The color of the white LED may have slight differences (for example, very light purple) on different models.
	Blue	Slow Blinking (Blink for 1 time, Off for 1 second)	The Zyxel Device is performing a Channel Availability Check (CAC) with Dynamic Frequency Selection (DFS) to monitor a channel for radar signals.
	Red	On	The Zyxel Device failed to boot up or is experiencing system failure.
		Fast Blinking (On for 50 milliseconds, Off for 50 milliseconds)	The Zyxel Device is undergoing firmware upgrade.
		Slow Blinking (Blink for 3 times, Off for 3 seconds)	The uplink of the Zyxel Device is disconnected.

NWA55BE

The System and Signal LED are located on the rear panel of the Zyxel Device.

Figure 28 NWA55BE LED

The following are the system LED indicator descriptions for the Zyxel Device.

Table 13 Zyxel Device System LED















COLOR		STATUS	DESCRIPTION
	Amber	Blinks between amber and green alternately (300 milliseconds interval).	The Zyxel Device is booting up.
	Green		
	Amber	Blinks between amber and green alternately (1 second interval).	The Zyxel Device is discovering the NCC.
	Green		
	Amber	Blinks between amber and green alternately 3 times and then turns solid green for 3 seconds.	The Zyxel Device is managed by the NCC but fails to connect with NCC, and is reconnecting with the NCC.
	Green		

Table 13 Zyxel Device System LED (continued)

COLOR		STATUS	DESCRIPTION
	Green	Slow Blinking (On for 1 second, Off for 1 second)	The wireless module of the Zyxel Device is disabled or fails, the Zyxel Device is using default WiFi settings, and/or the Zyxel Device is configured to be managed by the NCC but is not yet registered with the NCC.
	Green	Steady On	The Zyxel Device is ready for use, the Zyxel Device's wireless interface is activated, and WiFi clients are connected to the Zyxel Device.
	Bright Blue	Steady On	The Zyxel Device's wireless interface is activated, but there are no WiFi clients connected.
	White	Slow Blinking (On for 100 ms per second)	Locator LED is on. It switches off automatically after the configured amount of time (1-60 min). Default duration is 10 minutes. Note: The color of the white LED may have slight differences (for example, very light purple) on different models.
	Blue	Slow Blinking (Blink for 1 time, Off for 1 second)	The Zyxel Device is performing a Channel Availability Check (CAC) with Dynamic Frequency Selection (DFS) to monitor a channel for radar signals.
	Red	On	The Zyxel Device failed to boot up or is experiencing system failure.
		Fast Blinking (On for 50 milliseconds, Off for 50 milliseconds)	The Zyxel Device is undergoing firmware upgrade.
		Slow Blinking (Blink for 3 times, Off for 3 seconds)	The uplink of the Zyxel Device is disconnected.

The following are the signal LED indicator descriptions for the Zyxel Device.

Table 14 Zyxel Device Signal LED

COLOR		STATUS	DESCRIPTION
Repeater Mode			
	Green	Steady On	The WiFi signal strength between the Zyxel Device and the mesh AP is good. The signal strength is greater than -67 dBm.
	Amber	Steady On	The WiFi signal strength between the Zyxel Device and the mesh AP is fair. The signal strength is between -80 and -67 dBm.
	Red	Steady On	The WiFi signal strength between the Zyxel Device and the mesh AP is weak. The signal strength is below -80 dBm.
AP/Root Mode			
		Off	When the Zyxel Device is in AP/Root mode, the LEDs are off.

3.3 Ports

The following shows the Zyxel Device panels with connection ports.

802.11ax (WiFi 6) Dual- Radio PoE Access Point

- [NWA50AX, NWA90AX, NWA50AX PRO, and NWA90AX PRO](#)

802.11ax (WiFi 6) Dual- Radio Outdoor PoE Access Point

- [NWA55AXE](#)

802.11be (WiFi 7) Dual- Radio Desktop Access Point

- [NWA55AX PRO](#)

802.11be (WiFi 7) Dual- Radio PoE Access Point

- [NWA50BE, NWA90BE, NWA50BE PRO, and NWA90BE PRO](#)

802.11be (WiFi 7) Dual- Radio Outdoor PoE Access Point

- [NWA55BE](#)

NWA50AX, NWA90AX, NWA50AX PRO, and NWA90AX PRO

Place the Zyxel Device with the ports facing you and the wall mounting holes at the top.

Figure 29 NWA50AX/NWA90AX/NWA50AX PRO/NWA90AX PRO



The following are the items on the ports panels for your Zyxel Device.

Table 15 Ports and Buttons

LABEL	DESCRIPTION
POWER	Connect the power adapter and press the ON/OFF button to start the device
UPLINK	Connect the port to a router, a switch, or another access point (AP) to connect the Zyxel Device to the backbone of your network.
LAN	Connect computers or other Ethernet devices to Ethernet ports for Internet access.

Table 15 Ports and Buttons

LABEL	DESCRIPTION
CONSOLE	<p>You can use the console port to manage the Zyxel Device using CLI commands. You will be prompted to enter your user name and password. See the Command Reference Guide for more information about the CLI.</p> <p>When configuring using the console port, you need a computer equipped with communications software configured to the following parameters:</p> <ul style="list-style-type: none"> • Speed 115200 bps • Data Bits 8 • Parity None • Stop Bit 1 • Flow Control Off
RESET	Press the button for more than 5 seconds to return the Zyxel Device to the factory defaults.

NWA55AXE

Place the Zyxel Device with the ports and antennas facing you.

Figure 30 NWA55AXE



Note: The NWA55AXE does not have a reset button. Refer to [Ways to Reset a Zyxel Device without a Reset Button](#) to see how to reset your Zyxel Device to its factory default settings.

The following are the items on the ports panels for your Zyxel Device.

Table 16 Ports and Buttons

LABEL	DESCRIPTION
LAN	Connect computers or other Ethernet devices to Ethernet ports for Internet access.
POWER	Connect the power adapter and press the ON/OFF button to start the device

NWA55AX PRO

Place the Zyxel Device with the ports facing you.

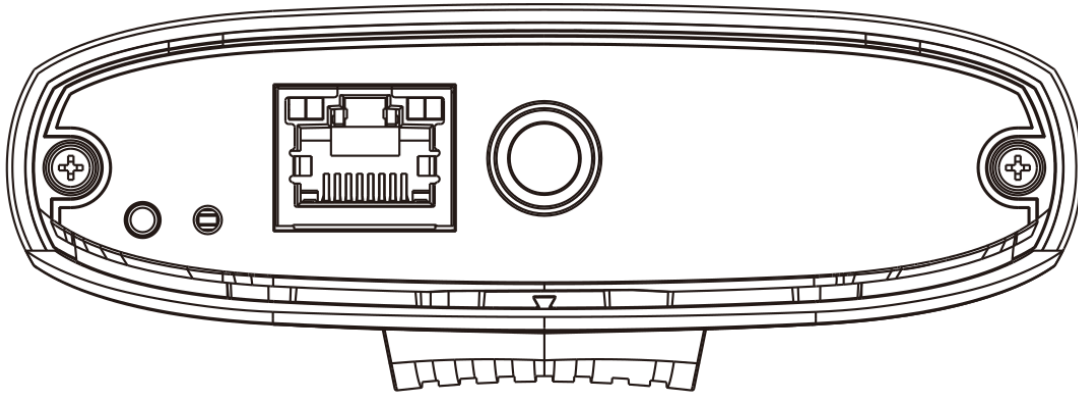
Figure 31 NWA55AX PRO

The following are the items on the ports panels for your Zyxel Device.

Table 17 Port and Button

LABEL	DESCRIPTION
Reset	Press the button for more than 5 seconds to return the Zyxel Device to the factory defaults.
Uplink (PoE IN)	Connect the port to a router, a switch, or another access point (AP) to connect the Zyxel Device to the backbone of your network.

NWA30BE

Place the Zyxel Device with the ports and antennas facing you.

Figure 32 NWA30BE

The following are the items on the ports panels for your Zyxel Device.

Table 18 Ports and Buttons

LABEL	DESCRIPTION
UPLINK	Connect the port to a router, a switch, or another access point (AP) to connect the Zyxel Device to the backbone of your network.
POWER	Connect the power adapter and press the ON/OFF button to start the device.
RESET	Press the button for more than 5 seconds to return the Zyxel Device to the factory defaults.

NWA50BE, NWA90BE, NWA50BE PRO, and NWA90BE PRO

Place the Zyxel Device with the ports facing you.

Figure 33 NWA50BE/NWA90BE/NWA50BE PRO/NWA90BE PRO



The following are the items on the ports panels for your Zyxel Device.

Table 19 Ports and Buttons

LABEL	DESCRIPTION
CONSOLE	<p>You can use the console port to manage the Zyxel Device using CLI commands. You will be prompted to enter your user name and password. See the Command Reference Guide for more information about the CLI.</p> <p>When configuring using the console port, you need a computer equipped with communications software configured to the following parameters:</p> <ul style="list-style-type: none"> • Speed 115200 bps • Data Bits 8 • Parity None • Stop Bit 1 • Flow Control Off
UPLINK	Connect the port to a router, a switch, or another access point (AP) to connect the Zyxel Device to the backbone of your network.

Table 19 Ports and Buttons

LABEL	DESCRIPTION
POWER	Connect the power adapter and press the ON/OFF button to start the device.
RESET	Press the button for more than 5 seconds to return the Zyxel Device to the factory defaults.

NWA55BE

Place the Zyxel Device with the antennas facing you.

Figure 34 NWA55BE



The following are the items on the ports panels for your Zyxel Device.

Table 20 Ports and Buttons

LABEL	DESCRIPTION
LAN	Connect computers or other Ethernet devices to Ethernet ports for Internet access.
POWER	Connect the power adapter and press the ON/OFF button to start the device.
RESET	Press the button for more than 5 seconds to return the Zyxel Device to the factory defaults.

3.3.1 Ways to Reset a Zyxel Device without a Reset Button

You can use the following ways to reset a Zyxel Device without a reset button to its factory default settings.

ZON Utility

- 1 Open the ZON Utility and click the **Clear and rescan** icon to scan for the Zyxel Device you want to reset.



- 2 Select the device and click the **Reset Configuration to Default** icon.



- 3 Enter the administrator password in the **Password** field on the pop-up screen and click **OK** to start the reset.

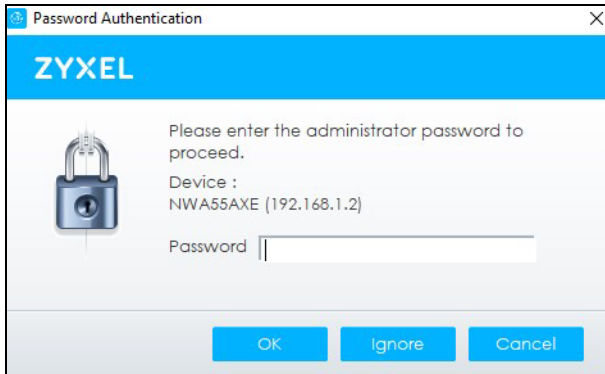

Web Configurator of the Zyxel Device Gateway

You can use this method if the Zyxel Device is connected to a Zyxel Switch with a Neighbor Reset function.

- 1 Log into the Zyxel switch's Web Configurator. Go to **Monitor > Neighbor**, and then click the **Restore** button to reset the Zyxel Device to its factory default settings.

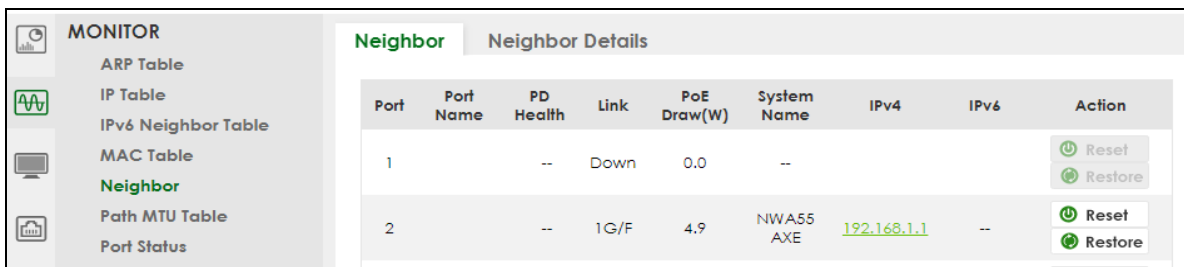

- 2 A pop-up window asks you to confirm that you want to reset the Zyxel Device to factory default. Click **OK** to proceed with reset. A count down starts.

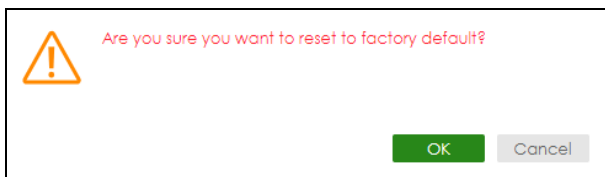

Nebula Control Center

If your Zyxel Device is registered with NCC, you can unregister it to reset it to its factory default settings.

- 1 Go to **Organization-wide > License & inventory > Devices** tab in the NCC portal.
- 2 Select the Zyxel Device you want to remove, then click **Actions > Remove from organization**.

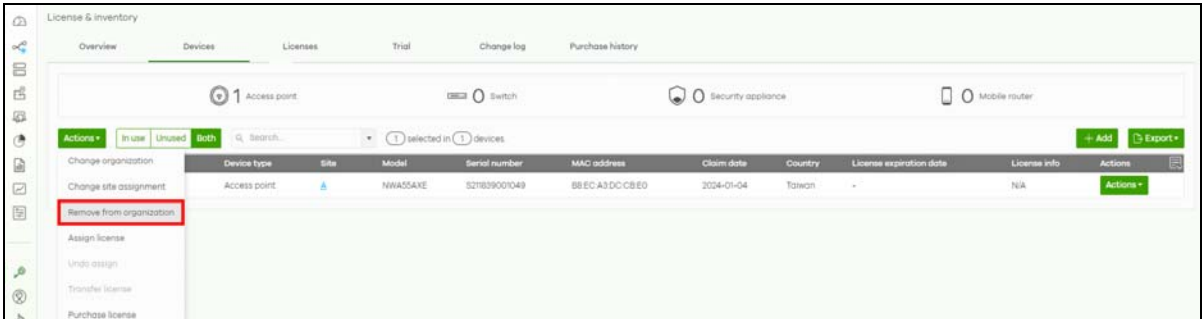

- 3 Click the **Yes** button to confirm.

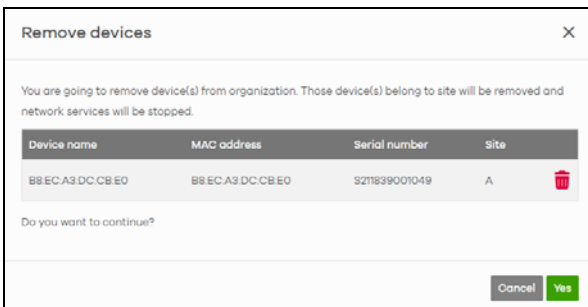

3.4 PoE

Power Over Ethernet (PoE) is a technology that allows Ethernet cables to supply power and transmit data simultaneously through a single Ethernet cable. You can use PoE when the Zyxel Device is hard to reach a power outlet or to simplify cabling.

The following example shows a Power Sourcing Equipment (**PSE**) supplying power and transmitting data to the Zyxel Device, along with other Powered Devices (PDs) such as an IP camera and an IP telephone.

Figure 35 PoE Example Application - PSE

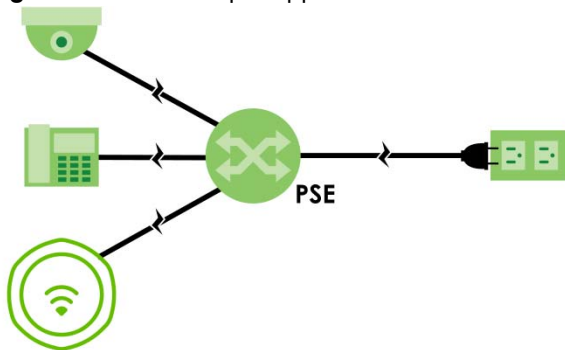

The following example shows a **PSE** using a PoE Extender (**PoEE**) to supply power and transmit data to the Zyxel Device, along with other PDs such as an IP camera and an IP telephone.

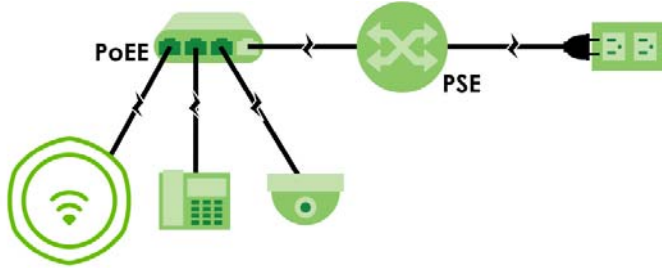
Figure 36 PoE Example Application - PSE with PoE Extender

The following example shows the PoE Injector (**PoEI**) delivering power from the power outlet and transmitting data from the non-PoE (**NPoE**) device to the Zyxel Device.

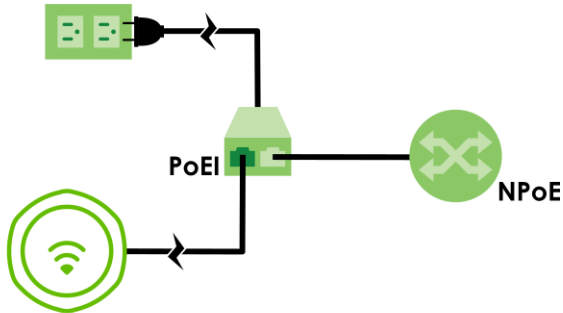
Figure 37 PoE Example Application - PoE Injector

To view the Zyxel Device's supported PoE standards, see [Zyxel Device Product Feature Comparison](#). Use Ethernet cables that correspond to the PoE standard your Zyxel Device supports (see [PoE](#)).

PoE standards are:

- IEEE 802.3af Power over Ethernet (PoE)
- IEEE 802.3at Power over Ethernet + (PoE+)
- IEEE 802.3bt Power over Ethernet ++ (PoE++)

The following table describes the PoE standards.

Table 21 PoE Standards

POE FEATURES	POE	POE+	POE++
IEEE Standard	IEEE 802.3af	IEEE 802.3at	IEEE 802.3bt
PoE Type	Type 1	Type 2	Type 3
PSE Port Power			
IEEE Power Classification	Class 0, 1, 2, 3	Class 4	Class 5, 6
Maximum Power Per Port	15.4 W	30 W	60 W
Port Voltage Range	44 – 57 V	50 – 57 V	50 – 57 V
Cables			
Twisted Pairs Used	2-pair	2-pair	4-pair
Supported Cables	Cat3 or better	Cat5 or better	Cat5 or better

CHAPTER 4

Web Configurator

4.1 Overview

The Web Configurator is an HTML-based management interface that allows easy system setup and management through Internet browser. Use a browser that supports HTML5, such as Mozilla Firefox, or Google Chrome, Microsoft Edge. The recommended screen resolution is 1024 by 768 pixels.

In order to use the Web Configurator you need to allow:

- Web browser pop-up windows from your device.
- JavaScript (enabled by default).
- Java permissions (enabled by default).

4.2 Accessing the Web Configurator

This section shows how to access the Web Configurator for the first time.

- 1 Ensure your Zyxel Device hardware is properly connected. See the Quick Start Guide.
- 2 Access the web configurator login screen through a WiFi or wired connection.

2a WiFi connection

From a WiFi-enabled device, search for the Zyxel Device's initial SSID (Zyxel-xxxx, where xxxx is the last four characters of the MAC address on the device label.) and connect to it. The web configurator appears once your computer connects to the initial SSID. If the web configurator does not appear automatically, open your web browser and enter "https://1.1.1.1" or "https://setup.zyxel.com".

Note: If the Zyxel Device cannot connect to the Internet, use the Zyxel Device's DHCP-assigned IP address to access its web configurator. Check the connected router or DHCP server for the IP address of the Zyxel Device.

Note: The default security mode for the Zyxel Device's initial SSID is enhanced-open. Client devices without enhanced-open support cannot connect to the initial SSID. Alternatively, you can use a wired connection to access the web configurator.

Init (initial) SSID (Service Set Identifier) is the default WiFi network name of the Zyxel Device. The default forwarding mode of the Zyxel Device is NAT (Network Address Translation) mode. This allows the Init SSID to be visible to your WiFi-enabled device and connect to the Zyxel Device. (see [SSID Forwarding Mode - NAT](#) for more information about forwarding mode.)

2b Wired connection

Use an Ethernet cable to connect your computer to the Zyxel Device. Open your web browser and enter the Zyxel Device's DHCP-assigned IP address or <http://192.168.1.2>. If the Zyxel Device and your computer are not connected to a DHCP server, ensure your computer's IP address is between "192.168.1.3" and "192.168.1.254".

- 3 Enter the user name (default: "admin") and default password. The default password is unique to each Zyxel Device and shown on the label. If your Zyxel Device does not have a password on the label, use "1234".

- 4 Select the language you prefer for the Web Configurator. Click **Login**.
- 5 Select a management mode. Select **Standalone** if you use the Web Configurator to manage your Zyxel Device. Select **Cloud Managed** if you use NCC to manage your Zyxel Device. Refer to [Management Mode](#) for more information about management mode. Click **Next**.

- 6 Check the **Reminders** on the screen. Click **Apply**. If you select **Cloud Managed**, refer to Nebula Control Center (NCC) to manage your Zyxel Device (see [Ways to Access the Zyxel Device](#) for more information). If you select **Standalone**, continue with the steps below.

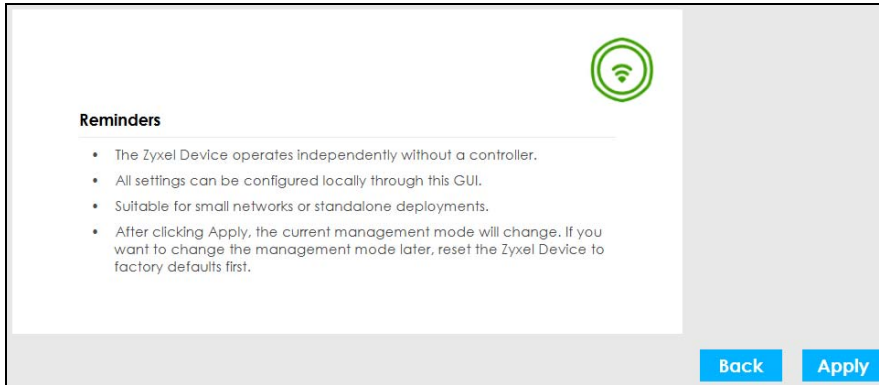

- 7 Set up a new password containing 4 to 63 printable characters. Spaces are not allowed. Click **Apply**.

- 8 Log in again with the user name (default: "admin") and the new password. Click **Login**.
- 9 The wizard screen appears. Please refer to [Accessing the Wizard](#) for wizard setup steps.

4.3 Navigating the Web Configurator

The following summarizes how to navigate the Web Configurator from the **Dashboard** screen. The figures below show the **Dashboard** screen in standalone mode and cloud managed mode. The screen layout may differ slightly depending on the mode and device model.

Figure 38 The Web Configurator's Dashboard for Standalone Mode

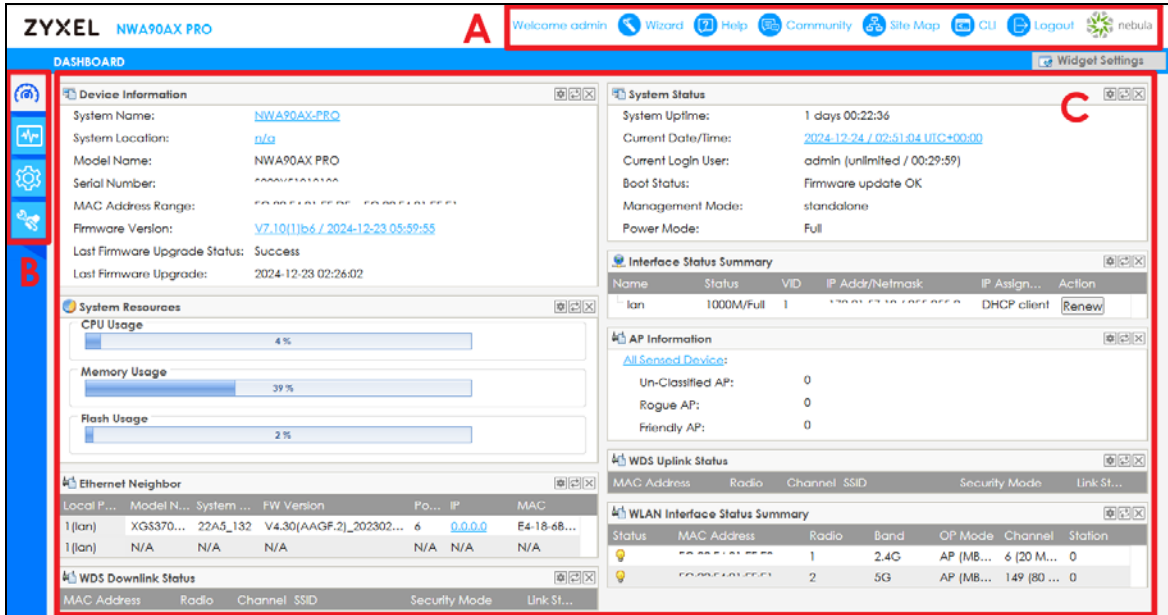
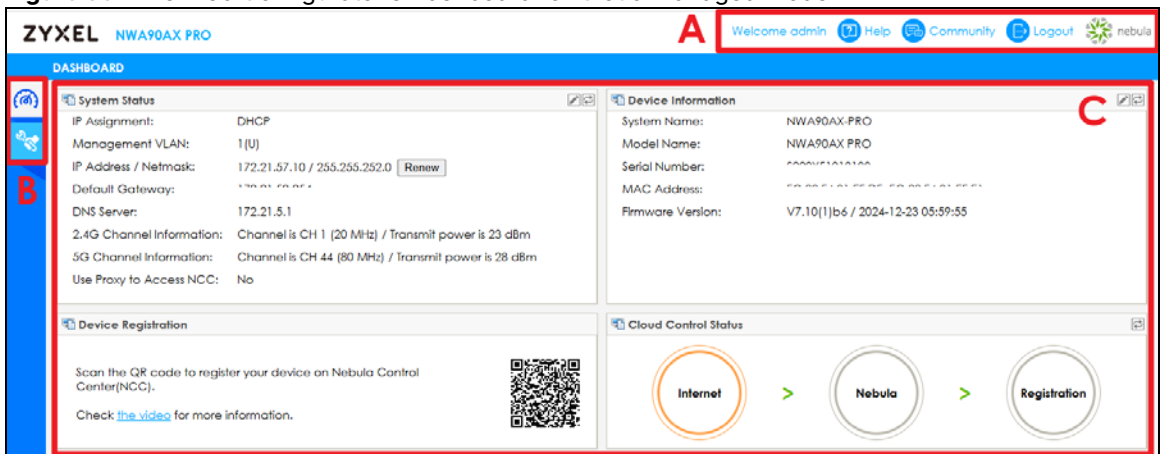

Figure 39 The Web Configurator's Dashboard for Cloud Managed Mode



The Web Configurator's main screen is divided into these parts:

- A - Title Bar
- B - Navigation Panel
- C - Main Window

4.3.1 Title Bar

The title bar provides some useful links that always appear over the screens below, regardless of how deep into the Web Configurator you navigate. If your Zyxel Device is in cloud managed mode, not all icons will be available in the title Bar.

Figure 40 Title Bar



The icons provide the following functions.

Table 22 Title Bar: Web Configurator Icons

LABEL	DESCRIPTION
Wizard	Click this to open the wizard. See Accessing the Wizard for more information.
Help	Click this to open the help page for the current screen.
Community	Click this to log into the Zyxel forum to post questions, contribute to a discussion and get feedback on Zyxel Device.
Site Map	Click this to see an overview of links to the Web Configurator screens.
CLI	Click this to open a popup window that displays the CLI commands sent by the Web Configurator.
Logout	Click this to log out of the Web Configurator.
nebula	Click this to open the NCC web site login page in a new tab or window.

Site Map

Click **Site MAP** to see an overview of links to the Web Configurator screens. Click a screen's link to go to that screen.

Figure 41 Site Map

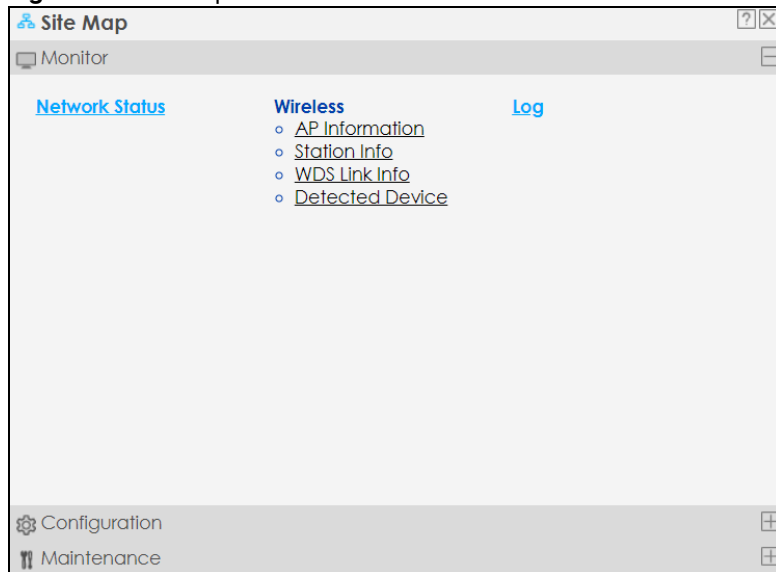

CLI Messages

Click **CLI** to look at the CLI commands sent by the Web Configurator. These commands appear in a popup window, such as the following.

Figure 42 CLI Messages



Click **Clear** to remove the currently displayed information.

Note: See the Command Reference Guide for information about the commands.

4.3.2 Navigation Panel

Use the menu items on the navigation panel to open screens to configure Zyxel Device features. Click the arrow in the middle of the right edge of the navigation panel to hide the navigation panel menus or drag it to resize them. The following sections introduce the Zyxel Device's navigation panel menus and their screens.

Figure 43 Navigation Panel

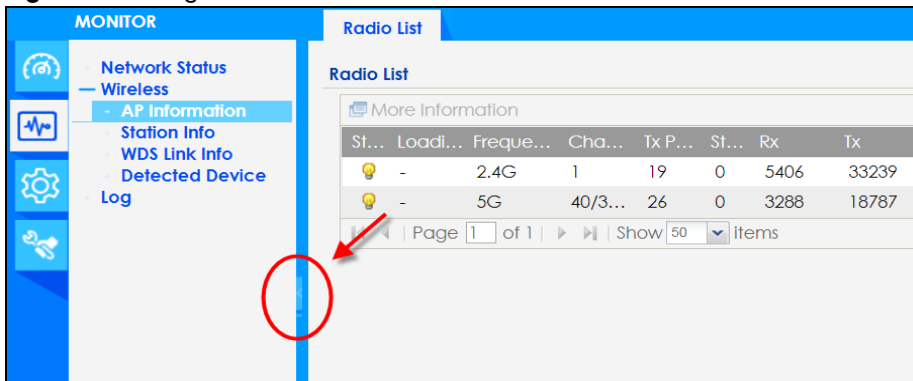

4.3.3 Standalone Mode Navigation Panel Menus

The following are the screens available in standalone mode. Note that some screens may not be available for your Zyxel Device model. See [Zyxel Device Product Feature Comparison](#) to see which features your Zyxel Device model supports.

Dashboard

The dashboard displays information such as general device information, system status, system resource usage, and interface status in widgets that you can rearrange to suit your needs.

For details on the Dashboard's features, see [Overview](#).

Monitor Menu

The monitor menu screens display status and statistics information.

Table 23 Monitor Menu Screens Summary

FOLDER OR LINK	TAB	FUNCTION
Network Status	Network Status	Display general LAN interface information and packet statistics.
Wireless		
AP Information	Radio List	Display information about the radios of the connected APs.
Station Info	Station List	Display information about the connected stations.
WDS Link Info	WDS Link Info	Display statistics about the Zyxel Device's WDS (Wireless Distribution System) connections.
Detected Device	Detected Device	Display information about suspected rogue APs.
Log	View Log	Display log entries for the Zyxel Device.

Configuration Menu

Use the configuration menu screens to configure the Zyxel Device's features.

Table 24 Configuration Menu Screens Summary

FOLDER OR LINK	TAB	FUNCTION
Network	IP Setting	Configure the IP address for the Zyxel Device Ethernet interface.
	VLAN	Manage the Ethernet interface VLAN settings.
Wireless		
AP Management	WLAN Setting	Manage the Zyxel Device's general WiFi settings.
Rogue AP	Rogue/Friendly AP List	Configure how the Zyxel Device monitors for rogue APs.
DCS	DCS	Configure dynamic WiFi channel selection.
Object		
User	User	Create and manage users.
User	Setting	Manage default settings for all users, general settings for user sessions, and rules to force user authentication.
AP Profile	Radio	Create and manage WiFi radio settings files that can be associated with different APs.
AP Profile	SSID	Create and manage WiFi SSID, security, MAC filtering, and layer-2 isolation files that can be associated with different APs.
WDS Profile	WDS	Create and manage WDS profiles that can be used to connect to different APs in WDS.
Certificate	My Certificates	Create and manage the Zyxel Device's certificates.
Certificate	Trusted Certificates	Import and manage certificates from trusted sources.
System		
Host Name	Host Name	Configure the system and domain name for the Zyxel Device.
Power Mode	Power Mode	Configure the Zyxel Device's power settings.
Date/Time	Date/Time	Configure the current date, time, and time zone in the Zyxel Device.
WWW	Service Control	Configure HTTP, HTTPS, and general authentication.
SSH	SSH	Configure SSH server and SSH service settings.

Table 24 Configuration Menu Screens Summary (continued)

FOLDER OR LINK	TAB	FUNCTION
FTP	FTP	Configure FTP server settings.
Log & Report		
Log Setting	Log Setting	Configure the system log and remote syslog servers.

Maintenance Menu

Use the maintenance menu screens to manage configuration and firmware files, run diagnostics, and reboot the Zyxel Device.

Table 25 Maintenance Menu Screens Summary

FOLDER OR LINK	TAB	FUNCTION
File Manager	Configuration File	Manage and upload configuration files for the Zyxel Device.
File Manager	Firmware Package	View the current firmware version and to upload firmware.
File Manager	Shell Script	Manage and run shell script files for the Zyxel Device.
Legal and Regulatory	Legal and Regulatory	View the legal and regulatory information of the Zyxel Device.
Diagnostics	Diagnostics	Collect diagnostic information.
Diagnostics	Remote Capture	Capture network traffic going through the Zyxel Device and output the captured packets to an analyzer.
LEDs	Suppression	Enable this feature to keep the LEDs off after the Zyxel Device starts.
LEDs	Locator	Enable this feature to see the actual location of the Zyxel Device between several devices in the network.
Reboot	Reboot	Restart the Zyxel Device.

4.3.4 Cloud Managed Mode Navigation Panel Menus

If your Zyxel Device is in cloud managed mode, you can use the Web Configurator for troubleshooting if your Zyxel Device cannot connect to the Internet.

Dashboard

The dashboard displays general Zyxel Device information, and AP information in widgets that you can rearrange to suit your needs.

For details on the Dashboard's features, see [Overview](#).

Maintenance Menu

Use the maintenance menu screens to manage configuration and firmware files, run diagnostics, and reboot the Zyxel Device.

Table 26 Maintenance Menu Screens Summary

FOLDER OR LINK	TAB	FUNCTION
File Manager	Firmware Package	View the current firmware version and to upload firmware.
File Manager	Shell Script	Manage and run shell script files for the Zyxel Device.
Legal and Regulatory	Legal and Regulatory	View the regulatory information.

Table 26 Maintenance Menu Screens Summary (continued)

FOLDER OR LINK	TAB	FUNCTION
Diagnostics	Diagnostics	Collect diagnostic information.
Diagnostics	Remote Capture	Capture network traffic going through the Zyxel Device and output the captured packets to an analyzer.
Reboot	Reboot	Restart the Zyxel Device.

4.3.5 Tables and Lists

The Web Configurator tables and lists are quite flexible and provide several options for how to display their entries.

4.3.5.1 Manipulating Table Display

Here are some of the ways you can manipulate the Web Configurator tables.

- 1 Click a column heading to sort the table's entries according to that column's criteria.

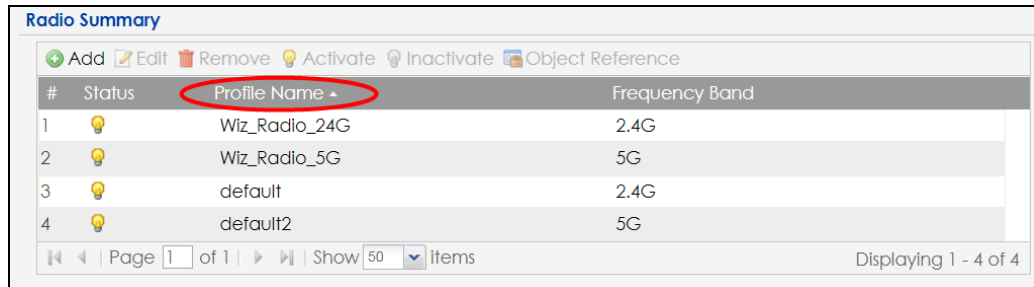

- 2 Click the down arrow next to a column heading for more options about how to display the entries. The options available vary depending on the type of fields in the column. Here are some examples of what you can do:

- Sort in ascending alphabetical order
- Sort in descending (reverse) alphabetical order
- Select which columns to display
- Group entries by field
- Show entries in groups
- Filter by mathematical operators (<, >, or =) or searching for text.

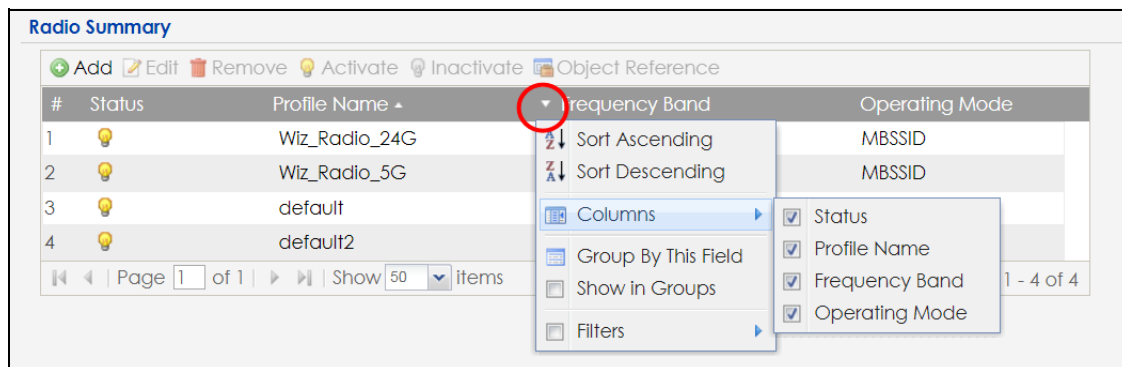

- 3 Select a column heading cell's right border and drag to re-size the column.

Radio Summary

Add
 Edit
 Remove
 Activate
 Inactivate
 Object Reference

#	Status	Profile Name	Frequency Band	Operating Mode
1		Wiz_Radio_24G	2.4G	MBSSID
2		Wiz_Radio_5G	5G	MBSSID
3		default	2.4G	MBSSID
4		default2	5G	MBSSID

Page 1 of 1 Show 50 items Displaying 1 - 4 of 4

- 4 Select a column heading and drag and drop it to change the column order. A green check mark displays next to the column's title when you drag the column to a valid new location.

Radio Summary

Add
 Edit
 Remove
 Activate
 Inactivate
 Object Reference

#	Status	Profile Name	Frequency Band	Operating Mode
1		default2	5G	MBSSID
2		default	2.4G	MBSSID
3		Wiz_Radio_5G	5G	MBSSID
4		Wiz_Radio_24G	2.4G	MBSSID

Page 1 of 1 Show 50 items Displaying 1 - 4 of 4

- 5 Use the icons and fields at the bottom of the table to navigate to different pages of entries and control how many entries display at a time.

Radio Summary

Add
 Edit
 Remove
 Activate
 Inactivate
 Object Reference

#	Status	Profile Name	Frequency Band	Operating Mode
1		default2	5G	MBSSID
2		default	2.4G	MBSSID
3		Wiz_Radio_5G	5G	MBSSID
4		Wiz_Radio_24G	2.4G	MBSSID

Page 1 of 1 Show 50 items Displaying 1 - 4 of 4

4.3.5.2 Working with Table Entries

The tables have icons for working with table entries. A sample is shown next. You can often use the [Shift] or [Ctrl] key to select multiple entries to remove, activate, or deactivate.

Figure 44 Common Table Icons

#	Status	Profile Name	Frequency Band	Operating Mode
1	🔦	Wiz_Radio_24G	2.4G	MBSSID
2	🔦	Wiz_Radio_5G	5G	MBSSID
3	🔦	default	2.4G	MBSSID
4	🔦	default2	5G	MBSSID
5	🔦	test	5G	MBSSID

Here are descriptions for the most common table icons.

Table 27 Common Table Icons

LABEL	DESCRIPTION
Add	Click this to create a new entry. For features where the entry's position in the numbered list is important (features where the Zyxel Device applies the table's entries in order like the firewall for example), you can select an entry and click Add to create a new entry after the selected entry.
Edit	Double-click an entry or select it and click Edit to open a screen where you can modify the entry's settings. In some tables you can just click a table entry and edit it directly in the table. For those types of tables small red triangles display for table entries with changes that you have not yet applied.
Remove	To remove an entry, select it and click Remove . The Zyxel Device confirms you want to remove it before doing so.
Activate	To turn on an entry, select it and click Activate .
Inactivate	To turn off an entry, select it and click Inactivate .
Object Reference	Select an entry and click Object Reference to open a screen that shows which settings use the entry.

PART I

Standalone Configuration

CHAPTER 5

Standalone Configuration

5.1 Overview

The Zyxel Device is in standalone mode by default. Use the Web Configurator to manage and configure the Zyxel Device directly. As shown in the following figure, WiFi clients can connect to the Zyxel Device (A) to access network resources.

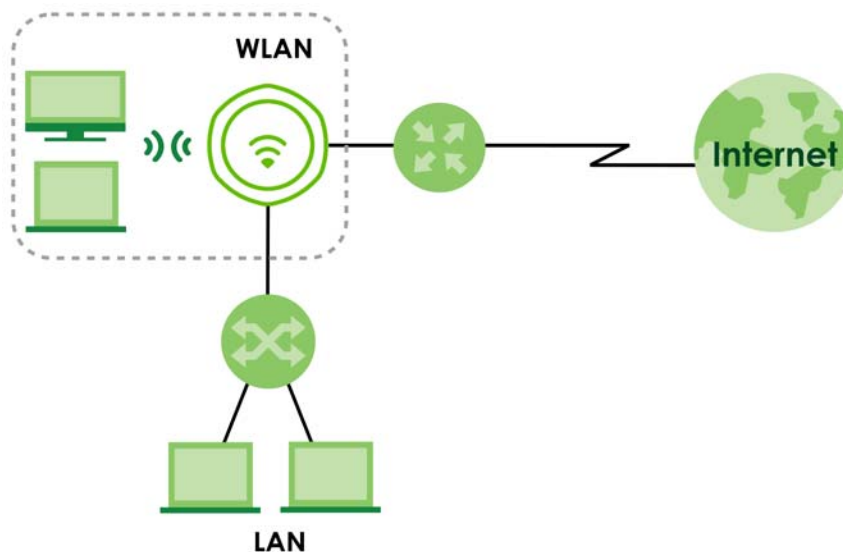

5.2 Starting and Stopping the Zyxel Device

Here are some of the ways to start and stop the Zyxel Device.

Table 28 Starting and Stopping the Zyxel Device

METHOD	DESCRIPTION
Turning on the power	A cold start occurs when you turn on the power to the Zyxel Device. The Zyxel Device powers up, checks the hardware, and starts the system processes.
Rebooting the Zyxel Device	A warm start (without powering down and powering up again) occurs when you use the Reboot button in the Reboot screen or when you use the <code>reboot</code> command. The Zyxel Device writes all cached data to the local storage, stops the system processes, and then does a warm start.

Table 28 Starting and Stopping the Zyxel Device (continued)

METHOD	DESCRIPTION
Using the RESET button	If you press the RESET button on the back of the Zyxel Device, the Zyxel Device sets the configuration to its default values and then reboots. See Resetting the Zyxel Device for more information. Note: Some models do not have a RESET button due to feature differences.
Disconnecting the power	Power off occurs when you turn off the power to the Zyxel Device. The Zyxel Device simply turns off. It does not stop the system processes or write cached data to local storage.

The Zyxel Device does not stop or start the system processes when you apply configuration files or run shell scripts although you may temporarily lose access to network resources.

CHAPTER 6

Dashboard

6.1 Overview

This screen displays general device information, system status, system resource usage, and interface status in widgets that you can rearrange to suit your needs. You can also collapse, refresh, and close individual widgets. Fields in this screen may slightly differ by models.

Figure 45 Dashboard

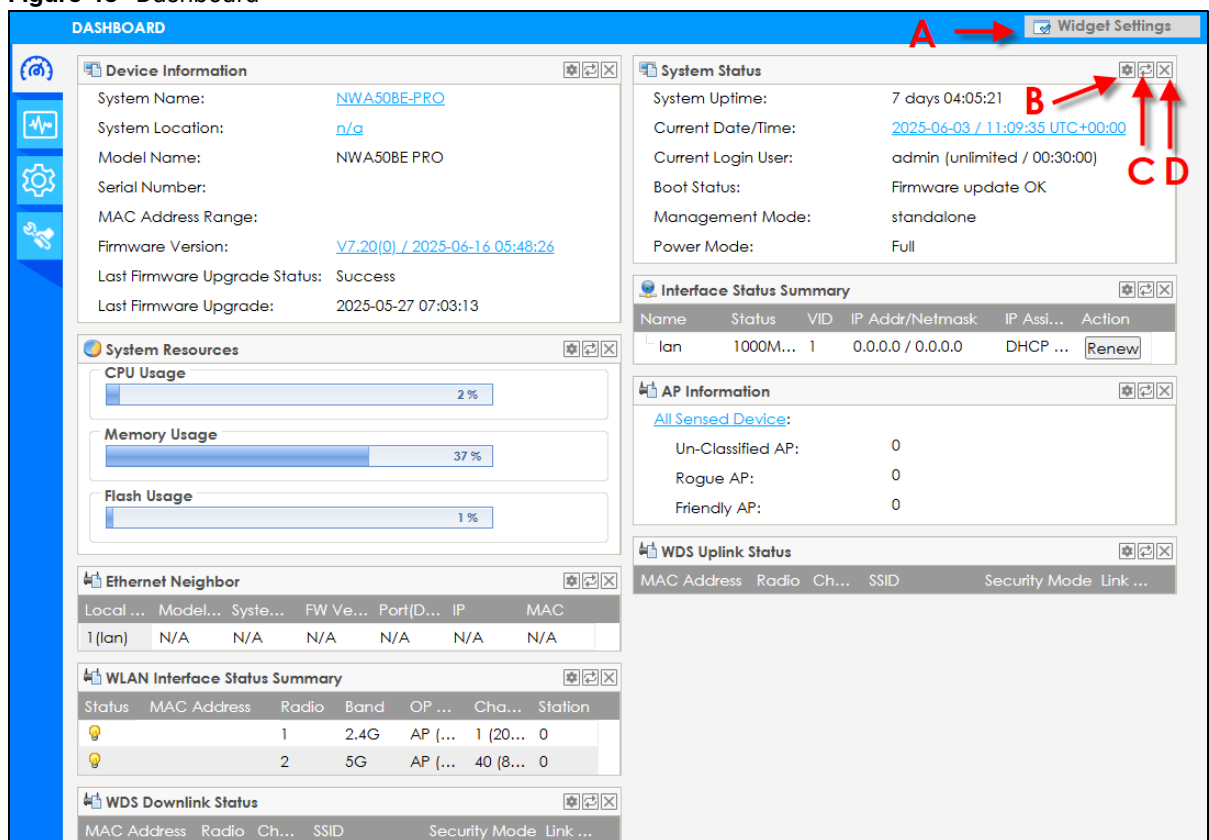

The following table describes the labels in this screen.

Table 29 Dashboard

LABEL	DESCRIPTION
Widget Settings (A)	Use this link to re-open closed widgets. Widgets that are already open appear grayed out.
Refresh Time Setting (B)	Set the interval for refreshing the information displayed in the widget.
Refresh Now (C)	Click this to update the widget's information immediately.
Close Widget (D)	Click this to close the widget. Use Widget Settings to re-open it.

Table 29 Dashboard (continued)

LABEL	DESCRIPTION
Device Information	
System Name	This field displays the name used to identify the Zyxel Device on any network. Click the icon to open the screen where you can change it.
System Location	This field displays the location of the Zyxel Device. Click the icon to open the screen where you can change it.
Model Name	This field displays the model name of this Zyxel Device.
Serial Number	This field displays the serial number of this Zyxel Device.
MAC Address Range	This field displays the MAC addresses used by the Zyxel Device. Each physical port or WiFi radio has one MAC address. The first MAC address is assigned to the Ethernet LAN port, the second MAC address is assigned to the first radio, and so on.
Firmware Version	This field displays the version number and date of the firmware the Zyxel Device is currently running. Click the icon to open the screen where you can upload firmware.
Last Firmware Upgrade Status	This field displays whether the latest firmware update was successfully completed.
Last Firmware Upgrade	This field displays the date and time when the last firmware update was made.
System Resources	
CPU Usage	This field displays what percentage of the Zyxel Device's processing capability is currently being used. Hover your cursor over this field to display the Show CPU Usage icon that takes you to a chart of the Zyxel Device's recent CPU usage.
Memory Usage	This field displays what percentage of the Zyxel Device's RAM is currently being used. Hover your cursor over this field to display the Show Memory Usage icon that takes you to a chart of the Zyxel Device's recent memory usage.
Flash Usage	This field displays what percentage of the Zyxel Device's onboard flash memory is currently being used.
Ethernet Neighbor	
Local Port (Description)	This field displays the port of the Zyxel Device, on which the neighboring device is discovered.
Model Name	This field displays the model name of the discovered device.
System Name	This field displays the system name of the discovered device.
FW Version	This field displays the firmware version of the discovered device.
Port (Description)	This field displays the discovered device's port which is connected to the Zyxel Device.
IP	This field displays the IP address of the discovered device. Click the IP address to access and manage the discovered device using its Web Configurator.
MAC	This field displays the MAC address of the discovered device.
WDS (Wireless Distribution System) Uplink/Downlink Status	
MAC Address	This field displays the MAC address of the root AP or repeater to which the Zyxel Device is connected using WDS.
Radio	This field displays the radio number on the root AP or repeater to which the Zyxel Device is connected using WDS.
Channel	This field displays the channel number on the root AP or repeater to which the Zyxel Device is connected using WDS.
SSID	This field displays the name of the WiFi network to which the Zyxel Device is connected using WDS.
Security Mode	This field displays which secure encryption methods is being used by the Zyxel Device to connect to the root AP or repeater using WDS.

Table 29 Dashboard (continued)

LABEL	DESCRIPTION
Link Status	This field displays the RSSI (Received Signal Strength Indicator) and transmission/reception rate of the wireless connection in WDS.
System Status	
System Uptime	This field displays how long the Zyxel Device has been running since it last restarted or was turned on.
Current Date/Time	This field displays the current date and time in the Zyxel Device. The format is yyyy-mm-dd hh:mm:ss.
Current Login User	This field displays the user name used to log in to the current session, the amount of reauthentication time remaining, and the amount of lease time remaining.
Boot Status	<p>This field displays details about the Zyxel Device's startup state.</p> <p>OK - The Zyxel Device started up successfully.</p> <p>Firmware update OK - A firmware update was successful.</p> <p>Problematic configuration after firmware update - The application of the configuration failed after a firmware upgrade.</p> <p>System default configuration - The Zyxel Device successfully applied the system default configuration. This occurs when the Zyxel Device starts for the first time or you intentionally reset the Zyxel Device to the system default settings.</p> <p>Fallback to lastgood configuration - The Zyxel Device was unable to apply the startup-config.conf configuration file and fell back to the lastgood.conf configuration file.</p> <p>Fallback to system default configuration - The Zyxel Device was unable to apply the lastgood.conf configuration file and fell back to the system default configuration file (system-default.conf).</p> <p>Booting in progress - The Zyxel Device is still applying the system configuration.</p>
Management Mode	This shows whether the Zyxel Device is set to work as a standalone AP.
Power Mode	<p>This displays the Zyxel Device's power status.</p> <p>Full - the Zyxel Device receives power using a power adapter and/or through a PoE switch/injector using IEEE 802.3at PoE plus or IEEE 802.3bt (WAX650S only at the time of writing).</p> <p>Limited - the Zyxel Device receives power through a PoE switch/injector using IEEE 802.3af PoE or IEEE 802.3at PoE plus (WAX650S only at the time of writing) even when it is also connected to a power source using a power adapter.</p> <p>When the Zyxel Device is in limited power mode, the Zyxel Device throughput decreases and has just one transmitting radio chain.</p> <p>It always shows Full if the Zyxel Device does not support power detection. See Zyxel Device Product Feature Comparison.</p>
Interface Status Summary	If an Ethernet interface does not have any physical ports associated with it, its entry is displayed in light gray text.
Name	This field displays the name of each interface.
Status	<p>This field displays the current status of each interface. The possible values depend on what type of interface it is.</p> <p>Inactive - The Ethernet interface is disabled.</p> <p>Down - The Ethernet interface is enabled but not connected.</p> <p>Speed / Duplex - The Ethernet interface is enabled and connected. This field displays the port speed and duplex setting (Full or Half).</p>
VID	This field displays the VLAN ID to which the interface belongs.

Table 29 Dashboard (continued)

LABEL	DESCRIPTION
IP Addr/Netmask	This field displays the current IP address and subnet mask assigned to the interface. If the IP address is 0.0.0.0, the interface is disabled or did not receive an IP address and subnet mask through DHCP.
IP Assignment	This field displays how the interface gets its IP address. Static - This interface has a static IP address. DHCP Client - This interface gets its IP address from a DHCP server.
Action	If the interface has a static IP address, this shows n/a . If the interface has a dynamic IP address, use this field to get or to update the IP address for the interface. Click Renew to send a new DHCP request to a DHCP server.
WLAN Interface Status Summary	This displays status information for the WLAN interface.
Status	This displays whether or not the WLAN interface is activated.
MAC Address	This displays the MAC address of the radio.
Radio	This indicates the radio number on the Zyxel Device.
Band	This indicates the WiFi frequency band currently being used by the radio.
OP Mode	This indicates the radio's operating mode. Operating modes are AP (MBSSID) , Root AP or Repeater .
Channel	This indicates the channel number the radio is using.
Station	This displays the number of WiFi clients connected to the Zyxel Device.
AP Information	This shows a summary of connected wireless Access Points (APs).
All Sensed Device	This sections displays a summary of all wireless devices detected by the network. Click the link to go to the Monitor > Wireless > Detected Device screen.
Un-Classified AP	This displays the number of detected unclassified APs.
Rogue AP	This displays the number of detected rogue APs.
Friendly AP	This displays the number of detected friendly APs.

6.1.1 CPU Usage

Use this screen to look at a chart of the Zyxel Device's recent CPU usage. To access this screen, click **CPU Usage** in the dashboard.

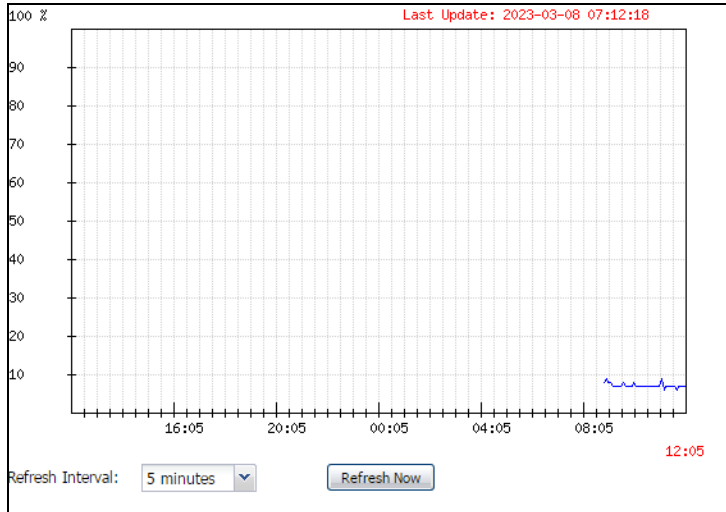
Figure 46 Dashboard > CPU Usage

The following table describes the labels in this screen.

Table 30 Dashboard > CPU Usage

LABEL	DESCRIPTION
%	The y-axis represents the percentage of CPU usage.
Time	The x-axis shows the time period over which the CPU usage occurred.
Refresh Interval	Enter how often you want this window to be automatically updated.
Refresh Now	Click this to update the information in the window right away.

6.1.2 Memory Usage

Use this screen to look at a chart of the Zyxel Device's recent memory (RAM) usage. To access this screen, click **Memory Usage** in the dashboard.

Figure 47 Dashboard > Memory Usage

The following table describes the labels in this screen.

Table 31 Dashboard > Memory Usage

LABEL	DESCRIPTION
%	The y-axis represents the percentage of RAM usage.
Time	The x-axis shows the time period over which the RAM usage occurred
Refresh Interval	Enter how often you want this window to be automatically updated.
Refresh Now	Click this to update the information in the window right away.

CHAPTER 7

Setup Wizard

7.1 Accessing the Wizard

When you log into the Web Configurator for the first time or when you reset the Zyxel Device to its default configuration, the wizard screen displays.

Note: If you have already configured the wizard screens and want to open it again, click the **Wizard** icon on the upper right corner of any Web Configurator screen.

7.2 Using the Wizard

This wizard helps you configure the Zyxel Device IP address, change time zone, daylight saving and radio settings, and edit an SSID profile to change general WiFi and WiFi security settings.

7.2.1 Step 1 Time Settings

Use this screen to configure the Zyxel Device's country code, time zone and daylight saving time.

- **Country:** Select the country where the Zyxel Device is located.

Note: The **Country** field is not available for the USA in order to comply with the U.S. laws, policies and regulations.

- **Time Zone:** Select the time zone of your Zyxel Device's location. This will set the time difference between your time zone and Coordinated Universal Time (UTC). UTC is a standard time for use around the world (formerly known as Greenwich Mean Time or GMT). UTC is an international abbreviation that is neither French nor English. It means both "Temps Universel Coordonné" and "Coordinated Universal Time".
- **Enable Daylight Saving:** Select this option if the location in which your Zyxel Device is uses Daylight Saving Time. Configure the date and time when Daylight Saving Time starts and ends.
- **Offset** allows you to specify how much the clock changes when daylight saving begins and ends. Enter a number from 1 to 5.5 (by 0.5 increments).

Click **Next** to proceed. Click **Exit** to close the wizard without saving.

Figure 48 Wizard: Time Settings

Figure 49 Wizard: Time Settings (with Country option)

7.2.2 Step 2 Uplink Connection

Use this screen to configure the Zyxel Device's IP address.

Uplink Connection: Select **Auto (DHCP)** if the Zyxel Device is connected to a router with DHCP server enabled. You then need to check the router for the IP address assigned to the Zyxel Device in order to access the Zyxel Device's Web Configurator.

Otherwise, select **Static IP** when the Zyxel Device is NOT connected to a router or you want to assign it a fixed IP address. You will need to manually enter:

- the Zyxel Device's IP address and subnet mask.
- the IP address of the router/gateway that helps forward traffic.

- a DNS server's IP address. The Domain Name System (DNS) maps a domain name to an IP address and so on. The DNS server is extremely important because without it, you must know the IP address of a computer before you can access it.

Click **Back** to return to the previous screen. Click **Next** to proceed. Click **Exit** to close the wizard without saving.

Figure 50 Wizard: Uplink Connection

Wizard Setting

Step 1

Uplink Connection:

Auto(DHCP) Static IP

IP Address:

Subnet Mask:

Gateway:

DNS Server:

Step 2

Step 3

Step 4

Step 5

Back Next Exit

7.2.3 Step 3 SSID

Use this screen to enable, disable or edit an SSID profile. An SSID profile is a configuration template for SSID (Service Set Identifier). It allows you to configure the SSID settings such as WiFi network name, VLAN ID, frequency band and security. You can configure multiple SSID profiles to provide different network access for various user groups.

Select an SSID profile and click the **Status** switch to turn it on or off. To change an SSID profile's settings, such as the SSID (WiFi network name) and WiFi password, double-click the SSID profile entry from the list. See [Edit SSID Profile](#) for more information.

Note: You must configure the first SSID in the list (default SSID).

Figure 51 Wizard: SSID (for 2.4 GHz and 5 GHz models)

Wizard Setting

Step 1

Step 2

Step 3

Step 4

Step 5

SSID

#	Status	SSID	Security	Band	VLAN ID
1	<input checked="" type="radio"/> ON	Unconfigured	OPEN	2.4G/5G	1
2	<input type="radio"/> OFF	Unconfigured	OPEN	2.4G/5G	1
3	<input type="radio"/> OFF	Unconfigured	OPEN	2.4G/5G	1
4	<input type="radio"/> OFF	Unconfigured	OPEN	2.4G/5G	1
5	<input type="radio"/> OFF	Unconfigured	OPEN	2.4G/5G	1
6	<input type="radio"/> OFF	Unconfigured	OPEN	2.4G/5G	1
7	<input type="radio"/> OFF	Unconfigured	OPEN	2.4G/5G	1
8	<input type="radio"/> OFF	Unconfigured	OPEN	2.4G/5G	1

Please configure the necessary SSID name and security settings.

Back Next Cancel

Figure 52 Wizard: SSID (for 2.4 GHz, 5 GHz, and 6 GHz models)

Wizard Setting

Step 1

Step 2

Step 3

Step 4

Step 5

SSID

#	Status	SSID	Security	Band	VLAN ID
1	<input checked="" type="radio"/> ON	Unconfigured	OPEN	2.4G/5G/6G	1
2	<input type="radio"/> OFF	Unconfigured	OPEN	2.4G/5G/6G	1
3	<input type="radio"/> OFF	Unconfigured	OPEN	2.4G/5G/6G	1
4	<input type="radio"/> OFF	Unconfigured	OPEN	2.4G/5G/6G	1
5	<input type="radio"/> OFF	Unconfigured	OPEN	2.4G/5G/6G	1
6	<input type="radio"/> OFF	Unconfigured	OPEN	2.4G/5G/6G	1
7	<input type="radio"/> OFF	Unconfigured	OPEN	2.4G/5G/6G	1
8	<input type="radio"/> OFF	Unconfigured	OPEN	2.4G/5G/6G	1

Please configure the necessary SSID name and security settings.

Back Next Exit

7.2.3.1 Edit SSID Profile

Use this screen to configure an SSID profile.

The screen varies depending on the security type you selected.

- **SSID:** Enter a descriptive name of up to 32 printable characters for the WiFi network.
- **Status:** Select **Active** to apply this SSID profile on all the radios. Select **Inactive** to create the SSID profile without applying this SSID on any radio.
- **VLAN ID:** Enter a VLAN ID for the Zyxel Device to use to tag traffic originating from this SSID.
- **Band:** Select the WiFi band which this profile should use. 2.4 GHz is the frequency used by IEEE 802.11b/g/n/ax WiFi clients. 5 GHz is the frequency used by IEEE 802.11a/n/ac/ax WiFi clients. 6 GHz is the frequency used by IEEE 802.11ax/be WiFi clients. See [Zyxel Device Product Feature Comparison](#) for models that support the 6 GHz band. See [WiFi 6 \(IEEE 802.11ax\)](#), [WiFi 6E \(IEEE 802.11ax - Extended Standard\)](#), and [WiFi 7 \(IEEE 802.11be\)](#) for more information about the IEEE standards.

- **Security Type:** Select **WPA2** or **WPA3** to add security on this WiFi network (recommended). Select **OPEN** or **Enhanced-Open** to allow any WiFi client to associate this network without authentication.
- **Transition Mode:** Select **WPA3** or **Enhanced-Open** for the **Security Type** to display this option. Select **Transition Mode** checkbox to enable this feature. Transition mode allows the Zyxel Device to create two virtual APs (VAPs): one using the primary (WPA3 or Enhanced-Open), and one using a fallback (WPA2 or none) security method. This allows both newer WiFi clients that support WPA3 and older clients that do not to connect to the Zyxel Device.
- **Personal:** Select this to store passwords for users on the Zyxel Device. Enter a pre-shared key of between 8 and 63 case-sensitive ASCII characters (including spaces and symbols) or 64 hexadecimal characters.
- **Enterprise:** Select this to store passwords for users on an external RADIUS authentication server. Select **Primary / Secondary RADIUS Server** checkbox to have the Zyxel Device use the specified RADIUS server. You have to enter the IP address, port number and shared secret password of the RADIUS server to be used for authentication.

Note: Not all Zyxel Devices support the enterprise authentication settings; see [Zyxel Device Product Feature Comparison](#) for more information.

Click **OK** to proceed. Click **Cancel** to close the screen without saving.

Figure 53 Wizard: SSID: Edit (WPA3-Personal)

Edit SSID Profile

SSID:

Status:

VLAN ID: (1~4094)

Band: 2.4G 5G 6G

Security Type:

Personal

Pre-Shared Key:

Transition Mode

Figure 54 Wizard: SSID: Edit (WPA3-Enterprise)

Edit SSID Profile

SSID: ⓘ

Status:

VLAN ID: (1~4094)

Band: 2.4G 5G

Security Type:

Personal

Enterprise

Primary RADIUS Server

RADIUS Server IP Address: ⓘ

RADIUS Server Port: ⓘ (1~65535)

RADIUS Server Secret: ⓘ

Secondary RADIUS Server

RADIUS Server IP Address:

RADIUS Server Port: (1~65535)

RADIUS Server Secret:

MLO in Firmware Version 7.20

To view the introduction of MLO (Multi-Link Operation), please refer to [Multi-Link Operation \(MLO\) on page 23](#).

In firmware version 7.20, MLO is automatically enabled for WiFi networks using the 802.11be radio. However, you cannot use **Open**, **WEP**, **WPA1**, **WPA2**, **WPA2-Mixed** security settings for any WiFi network using this radio nor hide a WiFi network SSID. In Nebula, you also cannot use **DPPSK** (Dynamic Personal Pre-Shared Key).

Note: If you configure any of these features for a WiFi network (SSID) using the 802.11be radio, then that WiFi network (SSID) will be disabled. You will see a log for this in the event logs. To re-enable the WiFi network (SSID), you must change the security setting to one of **Open**, **WPA1**, **WPA2**, **WPA2-Mixed**, unhide the SSID, and disable **DPPSK** (in Nebula).

To minimize impact on your existing WiFi network configurations, that may be using the above settings, firmware version 7.20 will cause the 2.4 GHz band to use the 802.11ax radio.

Note: **Open**, **WEP**, **WPA1**, **WPA2**, **WPA2-Mixed** and **DPPSK** will only work in the 2.4 GHz band. If your WiFi clients in this band do not use these settings, then set the radio mode to 802.11be for full WiFi 7 MLO functionality.

You should use **WPA3**, **WPA3 Transition**, or **Enhanced Open** security for WiFi networks using the 802.11be radio.

Version 7.20 Upgrade Automatic Changes

At the time of writing, upgrading to firmware version 7.20 will make these changes.

Table 32 Security Type in Firmware Version 7.20

EXISTING SECURITY	BAND	CHANGE
Open	2.4 GHz	None (recommend Enhanced Open)
	5 GHz	Enhanced Open
	6 GHz	Enhanced Open
Enhanced Open Transition	2.4 GHz	None (Recommend Enhanced Open unless legacy clients have connectivity issues.)
	5 GHz	Enhanced Open
	6 GHz	Enhanced Open
Enhanced Open	2.4 GHz	None
	5 GHz	None
WEP	2.4 GHz	None (Recommend WPA3 Transition)
	5 GHz	WiFi network (SSID) is disabled.
WPA1	2.4 GHz	None (Recommend WPA3 Transition)
	5 GHz	WiFi network (SSID) is disabled.
WPA2	2.4 GHz	None (Recommend WPA3 Transition)
	5 GHz	WPA3 Transition
WPA2-Mixed	2.4 GHz	None (Recommend WPA3 Transition)
	5 GHz	WiFi network (SSID) is disabled.
	6 GHz	WiFi network (SSID) is disabled.
WPA2-Mixed Enterprise	2.4 GHz	None (Recommend WPA3 Transition)
	5 GHz	WiFi network (SSID) is disabled.
	6 GHz	WiFi network (SSID) is disabled.
WPA2- Enterprise	2.4 GHz	None (Recommend WPA3 Transition)
	5 GHz	WPA3 Enterprise
	6 GHz	WPA3 Enterprise
WPA3- Transition	2.4 GHz	None
	5 GHz	None
	6 GHz	WPA3
WPA3	2.4 GHz	None
	5 GHz	None
	6 GHz	None
WPA3 - Enterprise	2.4 GHz	None
	5 GHz	None
	6 GHz	None
DPPSK (in Nebula)	2.4 GHz	None
	5 GHz	WiFi network (SSID) is disabled (Use the 802.11ax radio if you need DPPSK.)
	6 GHz	WiFi network (SSID) is disabled (Use the 802.11ax radio if you need DPPSK.)

7.2.4 Step 4 Radio

Use this screen to configure the Zyxel Device's radio transmitter(s).

- **Band:** This displays the radio band.
- **Channel Width:** Select the channel bandwidth list you want to use on this radio. The Zyxel Device will automatically choose the most suitable channel bandwidth from the bandwidth list you select based on your environment and client device type. See [Add or Edit Radio Profile](#).
- **Channel Selection:** Select **Auto** to have the Zyxel Device automatically choose a radio channel that has least interference. Otherwise, select **Manual** and specify a channel the Zyxel Device will use in the 2.4 GHz, 5 GHz and 6 GHz wireless LAN. The options vary depending on the frequency band and the country you are in.
- **Maximum Output Power:** Enter the maximum output power of the Zyxel Device. If there is a high density of APs in an area, decrease the output power of the Zyxel Device to reduce interference with other APs.

Note: Reducing the output power also reduces the Zyxel Device's effective broadcast radius.

Click **Back** to return to the previous screen. Click **Next** to proceed. Click **Exit** to close the wizard without saving.

Figure 55 Wizard: Radio (for 2.4 GHz and 5 GHz models)

The screenshot shows the 'Wizard Setting' interface with five steps. Step 4 is highlighted in blue. The settings for Step 4 are as follows:

Step	Setting	Value
Step 1	Band	2.4GHz
Step 2	Channel Width	20MHz
Step 2	Channel Selection	Auto (selected), Manual (6)
Step 3	Maximum Output Power	30 dBm(0~30)
Step 4	Band	5GHz
Step 4	Channel Width	160MHz
Step 4	Channel Selection	Auto, Manual (44) (selected)
Step 5	Maximum Output Power	30 dBm(0~30)

At the bottom right of the screen are three buttons: **Back**, **Next**, and **Exit**.

Figure 56 Wizard: Radio (for 2.4 GHz, 5 GHz, and 6 GHz models)

Wizard Setting

Step 1 **Radio**

Step 2 Band: 2.4GHz

Step 2 Channel Width: 20MHz

Step 2 Channel Selection: Auto Manual 6

Step 3 Maximum Output Power: 30 dBm(0~30)

Step 4 Band: 5G 6G

Step 4 Channel Width: 160MHz

Step 4 Channel Selection: Auto Manual 44

Step 5 Maximum Output Power: 30 dBm(0~30)

Back Next Exit

7.2.5 Step 5 Summary

Use this screen to check whether what you have configured is correct. Click **Save** to apply your settings and complete the wizard setup. Otherwise, click **Back** to return to the previous screen or click **Exit** to close the wizard without saving.

Figure 57 Wizard: Summary (for 2.4 GHz and 5 GHz models)

Wizard Setting

Step 1 **Summary**

Step 2 Time Zone: (UTC+08:00) Beijing, Hong Kong, Perth, Singapore, Taipei

Step 2 Daylight Saving: Disable

Step 2 Management IP: Auto(DHCP)

Step 3 2.4G Radio: Auto

Step 3 5G Radio: Channel 44

Step 4 SSID

#	Status	SSID	Security	Band	VLAN ID
1	ON	ZyxeL1111	WPA2-Personal	2.4G/5G	1
2	OFF	Unconfigured	OPEN	2.4G/5G	1
3	OFF	Unconfigured	OPEN	2.4G/5G	1
4	OFF	Unconfigured	OPEN	2.4G/5G	1

Step 5

Back Save Exit

Figure 58 Wizard: Summary (for 2.4 GHz, 5 GHz and 6 GHz models)

Wizard Setting

Step 1 **Summary**

Step 2 Time Zone: (UTC+08:00) Beijing, Hong Kong, Perth, Singapore, Taipei

Step 2 Daylight Saving: Disable

Step 2 Management IP: DHCP

Step 3 2.4G Radio: Auto

Step 3 5G Radio: Channel 44

Step 4 SSID

#	Status	SSID	Security	Band	VLAN ID
1	<input checked="" type="checkbox"/>	Zyxel	Enhanced-Open	2.4G/5G/6G	1
2	<input type="checkbox"/>	Unconfigured	OPEN	2.4G/5G/6G	1
3	<input type="checkbox"/>	Unconfigured	OPEN	2.4G/5G/6G	1
4	<input type="checkbox"/>	Unconfigured	OPEN	2.4G/5G/6G	1

Step 5

Back Save Exit

CHAPTER 8

Getting Started

8.1 Getting Started Overview

This chapter shows you how to use the Zyxel Device's various features.

- [WiFi Network Setup](#) - Choose the operation mode and set up a WiFi network.
- [Limit Network Bandwidth for Each WiFi Client](#) - Restrict the network bandwidth on a WiFi client.
- [Network Security](#) - Change the WiFi security, set up a RADIUS server, a rogue AP list, a friendly AP list, and a MAC filter list, and restrict users' access on the network.
- [Device Settings](#) - Change the management IP address, the login password, and the system name.
- [Device Management Using Nebula](#) - Register the Zyxel Device through the NCC Portal or the Nebula Mobile App.
- [Device Management Using Nebula](#) - Upgrade firmware, download and restore the device configuration.
- [Remote Access to the Zyxel Device](#) - Configure ways to access the Zyxel Device.

8.2 WiFi Network Setup

In this section, we show you how to:

- [Select the Operation Mode](#)
- [Set Up a WiFi Network in AP Mode](#)
- [Set Up a WiFi Network in Root AP/Repeater Mode](#)
- [Set Up General and Guest WiFi Networks on Both Radios](#)

8.2.1 Select the Operation Mode

The Zyxel Device has different Operation Modes (OP modes) to act as different roles in a network. You can select different OP modes for each radios. Not all OP modes are supported by all models. To select the OP mode, go to **Configuration > Wireless > AP Management**.

Figure 59 OP Modes

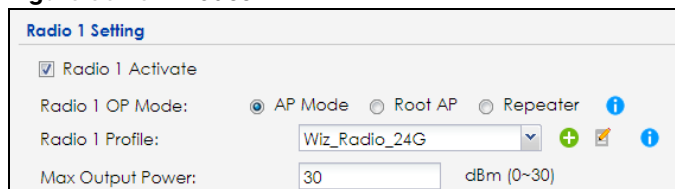

The Zyxel Device supports the following OP modes:

- Select **AP Mode** if you want WiFi clients to connect to the Zyxel Device.
- Select **Root AP Mode** if you want the Zyxel Device to wirelessly extend your WiFi network and also allow WiFi clients to connect to the Zyxel Device.
- Select **Repeater Mode** if you want the Zyxel Device to wirelessly extend your WiFi network (WDS).

8.2.2 Set Up a WiFi Network in AP Mode

This example uses the following parameters to set up a WiFi network.

Table 33 SSID Profile Settings Example

	PROFILE
SSID	Zyxel_Example
Channel Selection	36
Security Mode	wpa2
Pre-Shared Key	zyxel1234
802.11 Mode	11ax

- 1 Go to **Configuration > Object > AP Profile > Radio > Add**. Enter the profile name, select the 802.11 mode and select a channel (36 in this example) that is not used by another AP. Click **OK**.

General Settings

Activate

Profile Name:

802.11 Band: 2.4G 5G 6G

802.11 Mode:

Channel Width:

240MHz Support i

Channel Selection: DCS Manual i

- 2 Go to **Configuration > Object > AP Profile > SSID > SSID List**, select a SSID profile and click **Edit** to configure the SSID settings. Click **OK**.

Edit SSID Profile Zyxel_Example

Create new Object ▾

Profile Name:

SSID:

Band: 2.4G 5G 6G

Forwarding Mode:

Security Profile: + ✎

MAC Filtering Profile: +

Layer-2 Isolation Profile: +

QoS:

Rate Limiting (Per Station Traffic Rate)

Downlink: (0~160, 0 is unlimited)

Uplink: (0~160, 0 is unlimited)

VLAN ID: (1~4094)

Hidden SSID

Enable Intra-BSS Traffic blocking

Enable U-APSD

Enable Proxy ARP

802.11k/v Assisted Roaming

Schedule SSID

OK Cancel

- Go to **Configuration > Object > AP Profile > SSID > Security List** to set the **Security Mode** by clicking **Edit** and enter the **Pre-Shared Key**. Click **OK**.

Edit Security Profile default

Show Advanced Settings

General Settings

Profile Name:

Security Mode:

Authentication Settings

Enterprise

Personal

Pre-Shared Key:

Advance

OK Cancel

- To see your current WiFi settings and check if the WLAN connection is up, go to **Monitor > Wireless > AP Information**.

S..	Frequency Band	Cha...	Tra...	S..	Upload	Download	MAC Address	R..	OP Mode	AP / WDS Profile	Channel Utilization
🔦	2.4G	11 (2...	23	0	0	0	FC:22:F4:91:EF:E0	1	rootap	Wiz_Radio_24G / default	82%
🔦	5G	36 (1...	28	0	1888	5989	FC:22:F4:91:EF:E1	2	AP (MBS...	Wiz_Radio_5G / default	56%

Page 1 of 1 | Show 50 items | Displaying 1 - 2 of 2

- You can now allow your WiFi clients to search for the Zyxel Device's SSID and connect to the Zyxel Device's WiFi.

8.2.3 Set Up a WiFi Network in Root AP/Repeater Mode

To wirelessly extend a WiFi network (WDS), you need two Zyxel Devices, one in **Repeater** mode and one in **Root AP** mode. You should already have the root AP set up.

Note: The Zyxel Device in **Root AP/Repeater** mode cannot connect with other company's APs.

- 1 Go to **Configuration > Object > WDS Profile** in your root AP Web Configurator and click **Add**.
- 2 Enter a profile name, a WDS SSID, and a pre-shared key.

- 3 Go to **Configuration > Wireless > AP Management**, select the **Radio WDS Profile** of the radio on which you are setting the WDS connection to use the WDS profile you set, and click **Apply**.
- 4 Do steps 1 and 3 for the Zyxel Device in **Repeater** mode using the same WDS SSID and pre-shared key.
- 5 Once the security settings of the Zyxel Device in **Root AP** and **Repeater** modes match one another, the connection between the two Zyxel Devices is made.

If your Zyxel Device supports wireless bridging, you can extend a wired network from the port on the WiFi repeater, do the following steps:

- 6 Go to **Configuration > Wireless > AP Management**, select **Setup WDS Wireless Bridging** to enable WiFi bridge on the Zyxel Device in **Repeater** mode.
- 7 Connect the client device to the Zyxel Device's LAN port with an Ethernet cable.

Note: Make sure the VLAN settings on both the root AP and the WiFi repeater are exactly the same so they can communicate.

Note: When wireless bridge is enabled, WiFi interfaces for client devices will be disabled. You can only transmit data through the ports of the Zyxel Device in **Repeater** mode.

To set up a WDS in APC-managed Zyxel Devices, see the ZyWALL ATP, USG FLEX, or NCC User's Guide.

8.2.4 Set Up General and Guest WiFi Networks on Both Radios

The following example shows you how to create two WiFi networks (**Zyxel_General** and **Zyxel_Guest**) using the following settings for both **Radio 1** (2.4 GHz) and **Radio 2** (5 GHz). You should have already created two security profiles, **Security_Profile1** and **Security_Profile2**, on the **Configuration > Object > AP Profile > SSID > Security List** screen. See [Creating a Security Profile](#) for a tutorial on creating security profiles.

For the Guest WiFi, enable **Enable Intra-BSS Traffic blocking** to prohibit Guest WiFi clients from directly connecting to each other. To separate the **Guest WiFi** network from the **General** internal WiFi network, create two VLANs, **VLAN 10** and **VLAN 20**, on your firewall (F), such as ZyWALL. Set the **General** WiFi network to be in **VLAN 10**, where your internal network is. Set the **Guest** WiFi network to be in **VLAN 20**. This way, Guest WiFi clients will not be able to access the wired LAN network of the firewall (F) in **VLAN 10** while still able to access the Internet.

Figure 60 General and Guest WiFi Networks

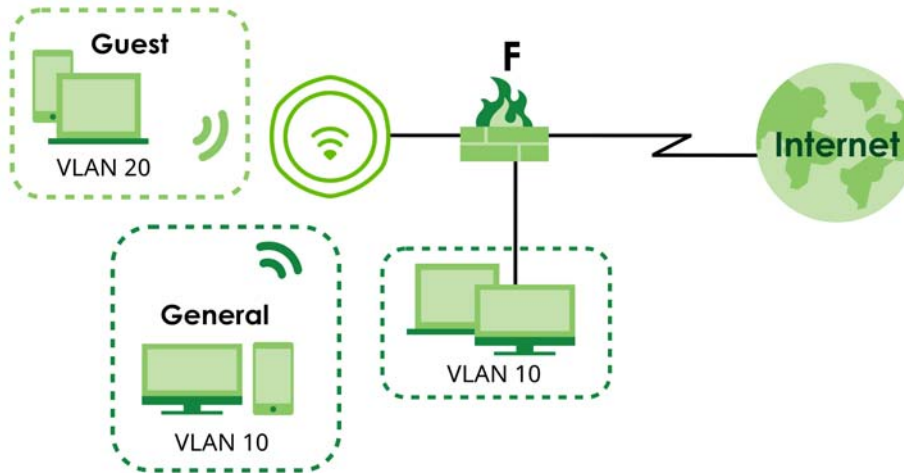

Table 34 General and Guest SSID Profiles

	GENERAL	GUEST
Profile Name	General	Guest
SSID	Zyxel_General	Zyxel_Guest
Band	2.4 GHz/5 GHz	2.4 GHz/5 GHz
Security Profile	Security_Profile1 Security Mode: WPA3 Authentication: Personal Pre-Shared Key: zyxel1234	Security_Profile2 Security Mode: WPA3 Authentication: Personal Pre-Shared Key: guest1234
VLAN ID	10	20
Rate Limiting	0 (unlimited)	Downlink: Up to 15 Mbps Uplink: Up to 10 Mbps
Enable Intra-BSS Traffic Blocking	Disabled	Enabled
Schedule SSID	No schedule	Monday-Friday: 09:00-17:00

- 1 Go to **Configuration > Object > AP Profile > SSID > SSID List**, click **Add** to create an SSID profile.
- 2 Configure the first SSID – **Zyxel_General** using the parameters given above, and then click **OK**.

Add SSID Profile

Create new Object ▾

Profile Name:

SSID:

Band: 2.4G 5G

Security Profile: + ✎

MAC Filtering Profile: +

Layer-2 Isolation Profile: +

QoS:

Rate Limiting (Per Station Traffic Rate)

Downlink: (0~160, 0 is unlimited)

Uplink: (0~160, 0 is unlimited)

VLAN ID: (1~4094)

Hidden SSID

Enable Intra-BSS Traffic blocking

Enable U-APSD

802.11k/v Assisted Roaming

Schedule SSID

OK Cancel

Edit SSID Profile General

Create new Object ▾

Profile Name:

SSID:

Band: 2.4G 5G 6G

Forwarding Mode:

Security Profile: + ✎

MAC Filtering Profile: +

Layer-2 Isolation Profile: +

QoS:

Rate Limiting (Per Station Traffic Rate)

Downlink: (0~160, 0 is unlimited)

Uplink: (0~160, 0 is unlimited)

VLAN ID: (1~4094)

Hidden SSID

Enable Intra-BSS Traffic blocking

Enable U-APSD

Enable Proxy ARP

802.11k/v Assisted Roaming

Schedule SSID

OK Cancel

- 3 Configure the second SSID – **ZyxeL_Guest** using the parameters given above, and then click **OK**.

Add SSID Profile ? ✕

Create new Object ▾

Profile Name:

SSID:

Band: 2.4G 5G

Security Profile: + ✎

MAC Filtering Profile: +

Layer-2 Isolation Profile: +

QoS:

Rate Limiting (Per Station Traffic Rate)

Downlink: (0~160, 0 is unlimited)

Uplink: (0~160, 0 is unlimited)

VLAN ID: (1~4094)

Hidden SSID

Enable Intra-BSS Traffic blocking

Enable U-APSD

802.11k/v Assisted Roaming

Schedule SSID

Sunday:	<input type="text" value="disable"/>	from:	<input type="text" value="00:00"/>	to:	<input type="text" value="24:00"/>
Monday:	<input type="text" value="enable"/>	from:	<input type="text" value="09:00"/>	to:	<input type="text" value="17:00"/>
Tuesday:	<input type="text" value="enable"/>	from:	<input type="text" value="09:00"/>	to:	<input type="text" value="17:00"/>
Wednesday:	<input type="text" value="enable"/>	from:	<input type="text" value="09:00"/>	to:	<input type="text" value="17:00"/>
Thursday:	<input type="text" value="enable"/>	from:	<input type="text" value="09:00"/>	to:	<input type="text" value="17:00"/>
Friday:	<input type="text" value="enable"/>	from:	<input type="text" value="09:00"/>	to:	<input type="text" value="17:00"/>
Saturday:	<input type="text" value="disable"/>	from:	<input type="text" value="00:00"/>	to:	<input type="text" value="24:00"/>

OK **Cancel**

Add SSID Profile

Create new Object ▾

Profile Name:

SSID:

Band: 2.4G 5G 6G

Forwarding Mode:

Security Profile: + ✎

MAC Filtering Profile: +

Layer-2 Isolation Profile: +

QoS:

Rate Limiting (Per Station Traffic Rate)

Downlink: (0~160, 0 is unlimited)

Uplink: (0~160, 0 is unlimited)

VLAN ID: (1~4094)

Hidden SSID

Enable Intra-BSS Traffic blocking

Enable U-APSD

Enable Proxy ARP

802.11k/v Assisted Roaming

Schedule SSID

Sunday:	<input type="text" value="disable"/>	from:	<input type="text" value="00:00"/>	to:	<input type="text" value="24:00"/>
Monday:	<input type="text" value="enable"/>	from:	<input type="text" value="09:00"/>	to:	<input type="text" value="17:00"/>
Tuesday:	<input type="text" value="enable"/>	from:	<input type="text" value="09:00"/>	to:	<input type="text" value="17:00"/>
Wednesday:	<input type="text" value="enable"/>	from:	<input type="text" value="09:00"/>	to:	<input type="text" value="17:00"/>
Thursday:	<input type="text" value="enable"/>	from:	<input type="text" value="09:00"/>	to:	<input type="text" value="17:00"/>
Friday:	<input type="text" value="enable"/>	from:	<input type="text" value="09:00"/>	to:	<input type="text" value="17:00"/>
Saturday:	<input type="text" value="disable"/>	from:	<input type="text" value="00:00"/>	to:	<input type="text" value="24:00"/>

- 4 Go to **Configuration > Wireless > AP Management**. Click the first **SSID Profile** of **Radio 1** (2.4 GHz). A drop-down list appears. Select the **General** SSID profile you just configured.

Radio 1 Setting

Radio 1 Activate

Radio 1 OP Mode: AP Mode Root AP Repeater ⓘ

Radio 1 Profile: + ✎ ⓘ

Max Output Power: dBm (0~30)

MBSSID Settings

#	SSID Profile	Band	
1	General	2.4G/5G/6G	+ ✎
2	disable		+
3	General		+
4	Guest		+
5	Zyxel_SSID_1		+

- 5 Click the second **SSID Profile** and select the **Guest** SSID profile.

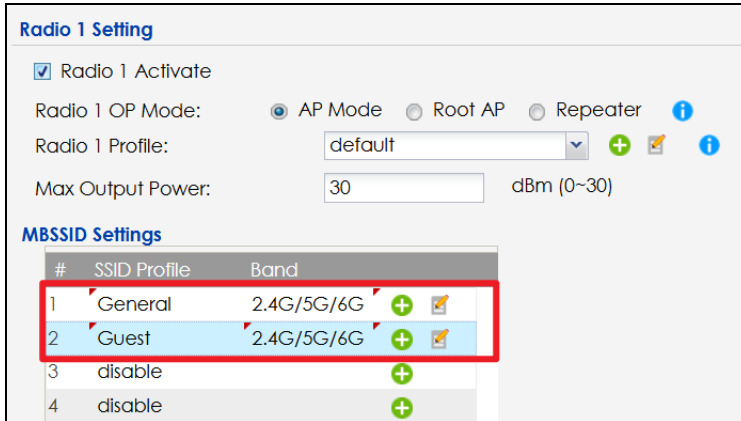

- Click the first **SSID Profile** of **Radio 2** (5 GHz). A drop-down list appears. Select the **General** SSID profile you just configured. Click the second **SSID Profile** and select the **Guest** SSID profile.
- Click **Apply** on the bottom of the screen. The **General** and **Guest** SSID profiles are now applied on **Radio 1** and **Radio 2**. You should now be able to see the **Zyxel_General** and **Zyxel_Guest** SSIDs on your WiFi devices for both 2.4 GHz and 5 GHz radio bands. General WiFi users can access the Internet and your local network. Guest users can only access the Internet.

8.3 Limit Network Bandwidth for Each WiFi Client

Restricting network bandwidth for each WiFi client ensures that all clients have equitable access to the network, preventing a few WiFi clients from monopolizing the bandwidth.

- Go to **Configuration > Object > AP Profile > SSID > SSID List**, select a profile and click **Edit**.

#	Profile Name	SSID	Security Profile	QoS	MAC Filter...	Layer-2 Isol...	VLAN ID
1	Guest	Zyxel_Guest	Security_Profile2	WMM	disable	disable	20
2	Zyxel_SSID_1	Zyxel	default	WMM	disable	disable	1
3	Zyxel_SSID_2	Zyxel	default	WMM	disable	disable	1
4	Zyxel_SSID_3	Zyxel	default	WMM	disable	disable	1
5	Zyxel_SSID_4	Zyxel	Security_Profile2	WMM	disable	disable	1
6	default	Zyxel-59B1	default	WMM	disable	disable	1

- Enter the maximum transmission data rate (either in Mbps or Kbps) for each WiFi client in the **Downlink** field.

Edit SSID Profile Zyxel_SSID_1

Create new Object

Profile Name: Zyxel_SSID_1

SSID: Zyxel

Band: 2.4G 5G 6G

Forwarding Mode: Local Bridge

Security Profile: Security_Profile 1

MAC Filtering Profile: disable

Layer-2 Isolation Profile: disable

QoS: WMM

Rate Limiting (Per Station Traffic Rate)

Downlink: 100 mbps (0~160, 0 is unlimited)

Uplink: 0 mbps (0~160, 0 is unlimited)

VLAN ID: 1 (1~4094)

Hidden SSID

Enable Intra-BSS Traffic blocking

Enable U-APSD

Enable Proxy ARP

802.11k/v Assisted Roaming

Schedule SSID

OK Cancel

- 3 Click **OK** to save your changes.

8.4 Network Security

In this section, we show you how to:

- [Change Security for a WiFi Network](#)
- [RADIUS Server Setup](#)
- [Set Up Rogue AP Detection](#)
- [Set Up a Friendly AP List](#)
- [Set Up a MAC Filter List](#)
- [Restrict Users' Access to Specific Parts of Your Network](#)
- [Test Your WiFi Access Restrictions](#)

8.4.1 Change Security for a WiFi Network

Changing the security settings on a WiFi network enhances protection by blocking unauthorized client devices. This option is ideal for small WiFi networks with a few WiFi clients. For WiFi networks with a lot of clients, see [RADIUS Server Setup](#) for more information.

- 1 Go to the **Configuration > Wireless > AP Management > WLAN Setting** screen. Click **Edit** under the SSID profile to change the WiFi security.

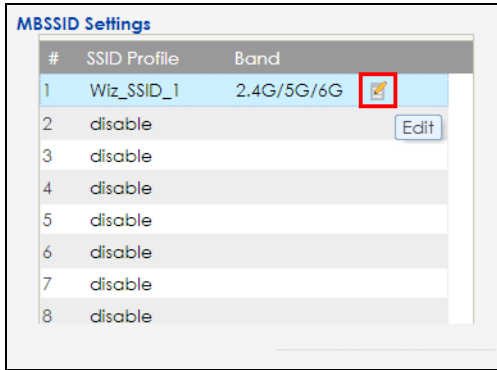

- 2 The following screen appears, click the **Edit** icon next to **Security Profile**.

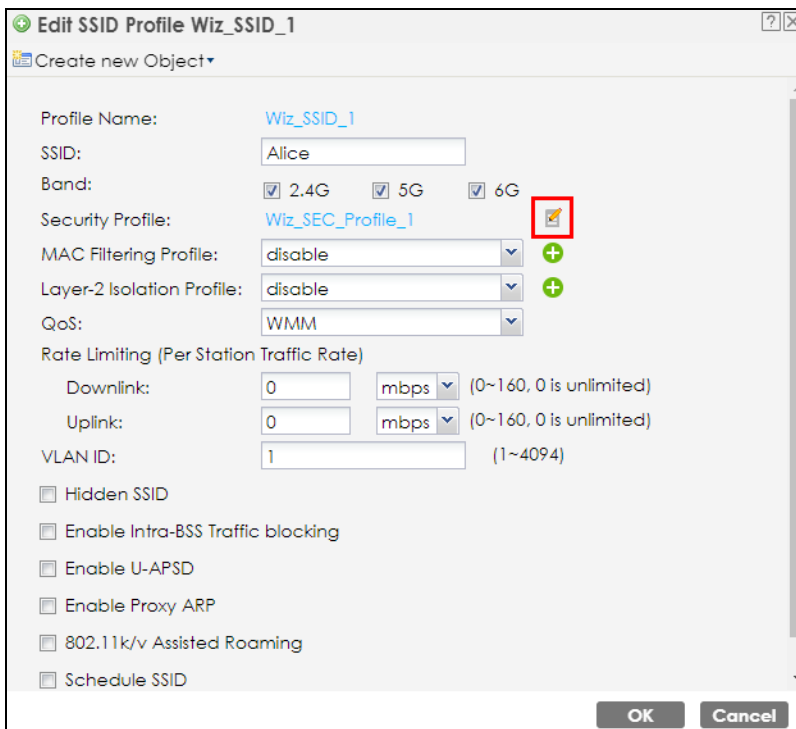

- 3 The following screen appears, select **Personal** and enter a pre-shared key from 8 to 63 case-sensitive keyboard characters in **Pre-Shared Key**. Click **OK** to save your changes.

Edit Security Profile Wiz_SEC_Profile_1

Show Advanced Settings

General Settings

Profile Name: Wiz_SEC_Profile_1

Security Mode: wpa2

Authentication Settings

Enterprise

Personal

Pre-Shared Key:

Advance

OK Cancel

8.4.2 RADIUS Server Setup

Setting up a RADIUS server on your Zyxel Device allows centralized user authentication and authorization, which enhances network security. This option is ideal for enterprise users who need to manage many WiFi clients.

- 1 Go to the **Configuration > Object > AP Profile > SSID > Security List** screen. Select a profile you want to configure for the RADIUS server and click **Edit**.

Security Summary

Edit Object Reference

#	Profile Name	Security Mode
1	Wiz_SEC_Profile_1	WPA2-Personal
2	Wiz_SEC_Profile_2	Open
3	Wiz_SEC_Profile_3	Open
4	Wiz_SEC_Profile_4	Open
5	Wiz_SEC_Profile_5	Open
6	Wiz_SEC_Profile_6	Open
7	Wiz_SEC_Profile_7	Open
8	Wiz_SEC_Profile_8	Open
9	default	Open

Page 1 of 1 | Show 50 items | Displaying 1 - 9 of 9

- 2 Set **Authentication Settings** to **Enterprise** to configure the RADIUS server. Enter the RADIUS server's IP address, port number and secret. The **Radius Server Secret** must match the secret on the RADIUS server client. Click **OK** to save your changes.

Edit Security Profile Wiz_SEC_Profile_1

Show Advanced Settings

General Settings

Profile Name: Wiz_SEC_Profile_1

Security Mode: wpa2

Authentication Settings

Enterprise

ReAuthentication Timer: 0 (30~30000 seconds, 0 is unlimited)

Personal

Advance

Radius Settings

Primary Radius Server Activate

Radius Server IP Address: 192.168.1.100

Radius Server Port: (1~65535)

Radius Server Secret: (1~65535)

Secondary Radius Server Activate

Primary Accounting Server Activate

Secondary Accounting Server Activate

OK Cancel

8.4.3 Set Up Rogue AP Detection

This example shows you how to configure the rogue AP detection feature on the Zyxel Device. A rogue AP is a WiFi access point operating in a network's coverage area that is not a sanctioned part of that network. See [Rogue AP](#) for background information on the rogue AP function and security considerations.

In this example, you want to ensure that your company's data is not accessible to an attacker gaining entry to your WiFi network through a rogue AP.

Your WiFi network operates in an office building. It consists of four Zyxel access points (all NWAs) and a variable number of WiFi clients. You also know that the coffee shop on the ground floor has a WiFi network consisting of a single access point (**AP 1**), which can be detected and accessed from your floor of the building. There are no other static WiFi networks in your coverage area.

The following diagram shows the WiFi networks in your area. Your access points are marked **A**, **B**, **C** and **D**. You also have a computer, marked **E**, connected to the wired network. The coffee shop's access point is marked **1**.

Figure 61 WiFi Network Example

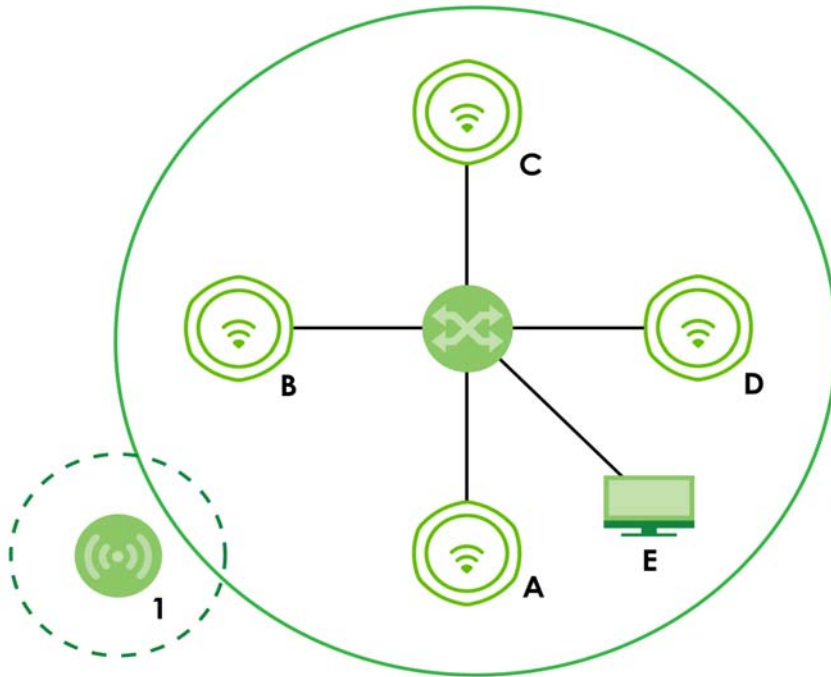

In the figure, the solid circle represents the range of your WiFi network, and the dashed circle represents the extent of the coffee shop's WiFi network. Note that the two networks overlap. This means that one or more of your APs can detect the **AP 1** in the other WiFi network.

When configuring the rogue AP feature on your Zyxel Device in this example, you will need to use the information in the following table. You need the IP addresses of your APs to access their Web configurators, and you need the MAC address of each AP to configure the friendly AP list.

Table 35 Rogue AP Example Information

DEVICE	IP ADDRESS	MAC ADDRESS
Access Point A	192.168.1.1	00:AA:00:AA:00:AA
Access Point B	192.168.1.2	AA:00:AA:00:AA:00
Access Point C	192.168.1.3	A0:0A:A0:0A:A0:0A
Access Point D	192.168.1.4	0A:A0:0A:A0:0A:A0
Access Point 1	Unknown	AF:AF:AF:FA:FA:FA

Note: You can detect the MAC addresses of other APs in the **Monitor > Wireless > Detected Device** screen. However, it is more secure to obtain the correct MAC addresses from another source and add them to the friendly AP list manually. For example, an attacker's AP mimicking the correct SSID could be placed on the friendly AP list by accident, if selected from the list of auto-detected APs.

In this example you have spoken to the coffee shop's owner, who has told you the correct MAC address of his **AP 1**.

8.4.4 Set Up a Friendly AP List

To find rogue APs, create a list of known friendly APs, then scan for all APs in your coverage area. Check if other APs are known and if not add them to the Rogue AP list.

Take the following steps to set up and save a list of access points you want to allow in your network's coverage area.

- 1 On a computer connected to the wired network (F in the previous figure), open your Internet browser and enter the URL of access point A (192.168.1.1). Login to the Web Configurator, go to **Configuration > Rogue AP > Rogue/Friendly AP List** and then click **Add** in the **Rogue/Friendly AP list** field.

- 2 Fill in the **MAC** and **Description** fields as in the following table. Click **Add** after you enter the details of each AP to include it in the list.

MAC ADDRESS	DESCRIPTION
00:AA:00:AA:00:AA	My Access Point _A_
AA:00:AA:00:AA:00	My Access Point _B_
A0:0A:A0:0A:A0:0A	My Access Point _C_
0A:A0:0A:A0:0A:A0	My Access Point _D_
AF:AF:AF:FA:FA:FA	Coffee Shop Access Point _1_

Note: You can add APs that are not part of your network to the friendly AP list, as long as you know that they do not pose a threat to your network's security.

The Friendly AP screen now appears as follows.

- 3 Next, click **Apply** to save the list of friendly APs in order to provide a backup and upload it to your other access points.
- 4 Click **Exporting** in the **Friendly AP List Importing/Exporting** field. If a window similar to the following appears, click **Save**.

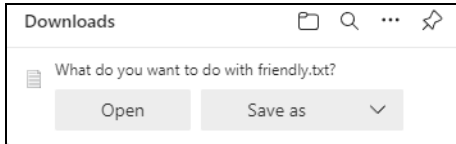

- 5 Save the friendly AP list somewhere it can be accessed by all the other access points on the network. In this example, save it on the network file server. The default filename is "friendly".

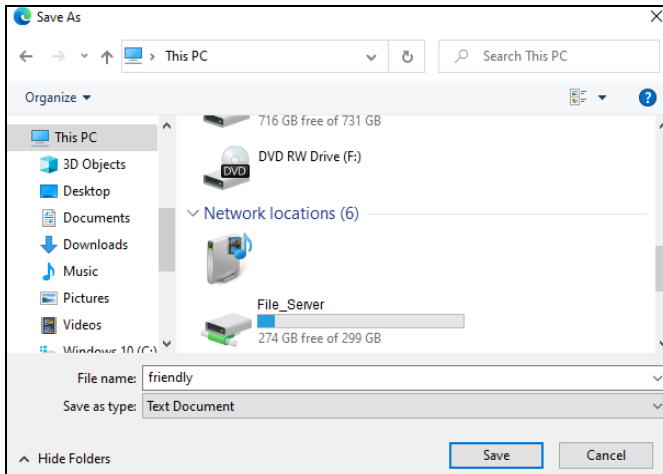

8.4.4.1 Import the Friendly AP List to Other APs

Access point **A** is now configured to do the following.

- Scan for access points in its coverage area
- Recognize friendly access points from a list

Now you need to configure the other WiFi access points in your network to do the same things.

For each access point, take the following steps.

- 1 From a computer on the wired network, enter the access point's IP address and log into its Web Configurator.
- 2 Import the friendly AP list. Click **Configuration > Wireless > Rogue AP > Rogue/Friendly AP List**, and click **Browse** in the **Friendly AP List Importing/Exporting** field. Find the "friendly" file where you previously saved it on the network and click **Open**. Then, click **Importing**.

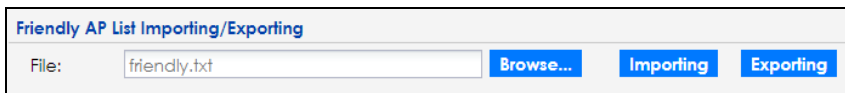

- 3 Check the **Configuration > Wireless > Rogue AP > Rogue/Friendly AP List** screen to ensure that the friendly AP list has been correctly uploaded.

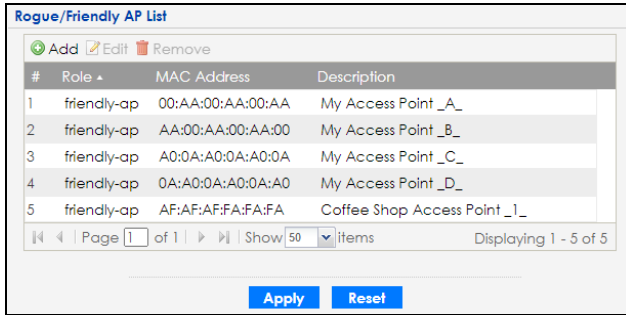

8.4.5 Set Up a MAC Filter List

A MAC filter list blocks or allows a list of clients based on their MAC addresses, ensuring only authorized clients can access the network. This example shows how to block certain clients based on their MAC addresses.

- 1 Go to **Configuration > Object > AP Profile > SSID > MAC Filter List** and then click **Add**.
- 2 Fill in the **Profile Name** and select **deny** for **Filter Action**. Click **Add** to add a new MAC address to block. Enter the MAC addresses of the clients you want to block under the **MAC** field and then click **OK**.

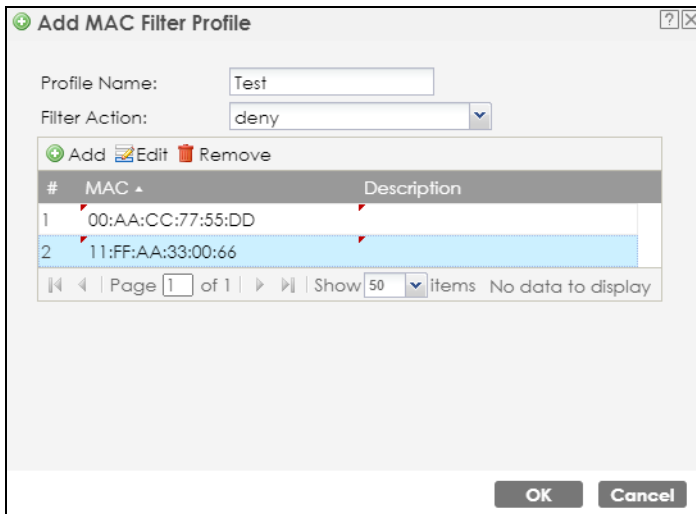

8.4.6 Restrict Users' Access to Specific Parts of Your Network

This example shows you how to allow certain users to access only specific parts of your network. You can do this by using multiple MAC filters and layer-2 isolation profiles.

8.4.6.1 Scenario

In this example, you run a company network in which certain employees must wirelessly access secure file servers containing valuable proprietary data.

You have two secure servers (**1** and **2** in the following figure). WiFi user "Alice" (**A**) needs to access server **1** (but should not access server **2**) and WiFi user "Bob" (**B**) needs to access server **2** (but should not

access server 1). Your Zyxel Device is marked **ZD**. **C** is a workstation on your wired network, **D** is your main network switch, and **E** is the security gateway you use to connect to the Internet.

Figure 62 Getting Started: Example Network

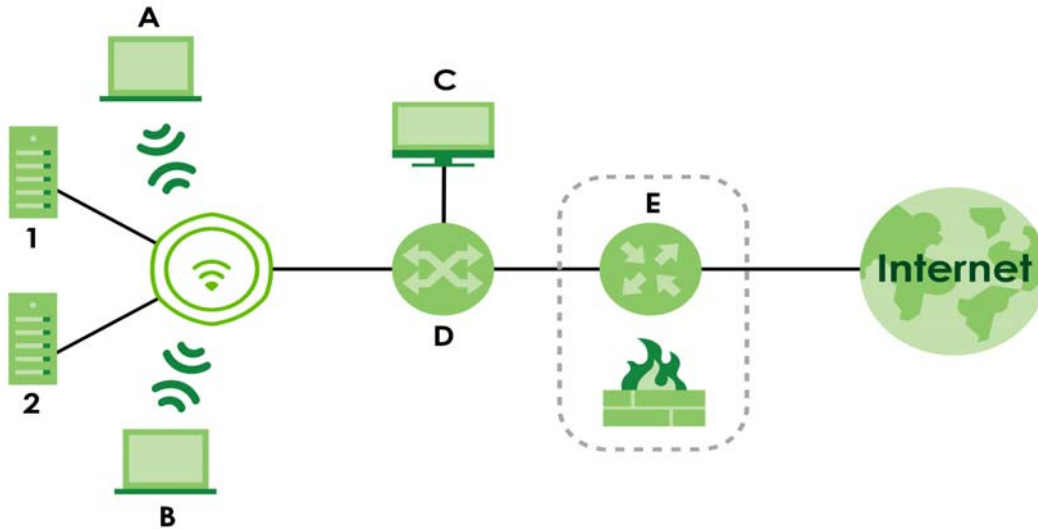

8.4.6.2 Your Requirements

- 1 You want to set up a WiFi network to allow only Alice to access server 1 and the Internet.
- 2 You want to set up a second WiFi network to allow only Bob to access server 1 and the Internet.

8.4.6.3 Setup

In this example, you have already set up the Zyxel Device in **AP Mode** (see [WiFi Network Setup](#)). It uses two SSID profiles simultaneously. You have configured each SSID profile as shown in the following table.

Table 36 SSID Profile Security Settings

SSID Profile Name	SERVER_1	SERVER_2
SSID	SSID_S1	SSID_S2
Security	Security Profile security03: WPA2-PSK Hide SSID	Security Profile security04: WPA2-PSK Hide SSID
Intra-BSS traffic blocking	Enabled	Enabled

Each SSID profile already uses a different pre-shared key.

In this example, you will configure access limitations for each SSID profile. To do this, you will take the following steps.

- 1 Configure the SERVER_1 network's SSID profile to use specific MAC filter and layer-2 isolation profiles.
- 2 Configure the SERVER_1 network's MAC filter profile.
- 3 Configure the SERVER_1 network's layer-2 isolation profile.

- 4 Repeat steps 1 to step 3 for the SERVER_2 network.
- 5 Check your settings and test the configuration.

To configure layer-2 isolation, you need to know the MAC addresses of the devices on your network, which are as follows.

Table 37 Getting Started: Example Network MAC Addresses

DEVICE	LABEL	MAC ADDRESS
Zyxel Device	ZD	BB:AA:99:88:77:66
Secure Server 1	1	AA:99:88:77:66:55
Secure Server 2	2	99:88:77:66:55:44
Workstation	C	88:77:66:55:44:33
Switch	D	77:66:55:44:33:22
Security gateway	E	66:55:44:33:22:11

To configure MAC filtering, you need to know the MAC addresses of the devices Alice and Bob use to connect to the network, which are as follows.

Table 38 Example User MAC Addresses

USER	MAC ADDRESS
Alice	11:22:33:44:55:66
Bob	22:33:44:55:66:77

8.4.6.4 Configure the SERVER_1 Network

First, you will set up the SERVER_1 network which allows Alice to access secure server 1 through the network switch.

You will configure the MAC filter to restrict access to Alice alone, and then configure layer-2 isolation to allow her to access only the network router, the file server and the Internet security gateway.

Take the following steps to configure the SERVER_1 network.

- 1 Go to **Configuration > Object > AP Profile > SSID > SSID List**. The following screen displays, showing the SSID profiles you already configured. Select **SERVER_1**'s entry and click **Edit**.

- The following screen appears. Select **I2Isolation03** for **Layer-2 Isolation Profile**, and select **macfilter03** for **MAC Filtering Profile**. Click **OK**.

Figure 63 SSID Edit Example

Wiz_SSID_1

Create new Object ▾

Profile Name: Wiz_SSID_1

SSID: Zyxel

Band: 2.4G 5G

Security Profile: Wiz_SEC_Profile_1

MAC Filtering Profile: macfilter03

Layer-2 Isolation Profile: I2Isolation03

QoS: WMM

Rate Limiting (Per Station Traffic Rate)

Downlink: 0 mbps (0~160, 0 is unlimited)

Uplink: 0 mbps (0~160, 0 is unlimited)

VLAN ID: 1 (1~4094)

Hidden SSID

Enable Intra-BSS Traffic blocking

Enable U-APSD

802.11k/v Assisted Roaming

Schedule SSID

OK Cancel

- Click the **Layer-2 Isolation List** tab. Select the **I2Isolation03**'s entry and click **Edit**. The following screen displays.

Figure 64 Layer-2 Isolation Edit

L2-ISO_SERVER_1

Profile Name: L2-ISO_SERVER_1

Allow devices with these MAC addresses:

+ Add Edit Remove

#	MAC	Description
1	77:66:55:44:33:22	NET_ROUTER
2	AA:99:88:77:66:55	SERVER_1
3	66:55:44:33:22:11	GATEWAY

Page 1 of 1 Show 50 items Displaying 1 - 2 of 2

OK Cancel

- Enter the network router's MAC Address and add a Description ("NET_ROUTER" in this case) in Set 1's entry.
- Enter server 1's MAC Address and add a Description ("SERVER_1" in this case) in Set 2's entry.
- Change the **Profile Name** to "L2-ISO_SERVER_1" and click **OK**. You have restricted users on the SERVER_1 network to access only the devices with the MAC addresses you entered.
- Go to the **MAC Filter List** tab. Then, select **macfilter03**'s entry and click **Edit**.

- 8 Enter the MAC address of the device Alice uses to connect to the network in **Set 1's MAC Address** field and enter her name in the **Description** field, as shown in the following figure. Change the **Profile Name** to "MacFilter_SERVER_1". Select **Allow** from the **Filter Action** field and click **OK**.

Figure 65 MAC Filter Edit (SERVER_1)

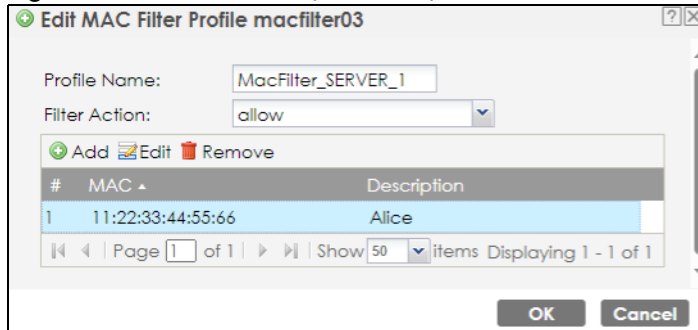

You have restricted access to the SERVER_1 network to only the networking device whose MAC address you entered. The SERVER_1 network is now configured.

8.4.6.5 Configure the SERVER_2 Network

Next, you will configure the SERVER_2 network that allows Bob to access secure server 2 and the Internet.

To do this, repeat the procedure in [Configure the SERVER_1 Network](#), substituting the following information.

Table 39 SERVER_2 Network Information

SSID Screen	
Index	4
Profile Name	SERVER_2
SSID Edit (SERVER_2) Screen	
L2 Isolation	I2Isolation04
MAC Filtering	macfilter04
Layer-2 Isolation (I2Isolation04) Screen	
Profile Name	L2-ISO_SERVER-2
Set 1	MAC Address: 77:66:55:44:33:22 Description: NET_ROUTER
Set 2	MAC Address: 99:88:77:66:55:44 Description: SERVER_2
Set 3	MAC Address: 66:55:44:33:22:11 Description: GATEWAY
MAC Filter (macfilter04) Edit Screen	
Profile Name	MacFilter_SERVER_2
Set 1	MAC Address: 22:33:44:55:66:77 Description: Bob

8.4.7 Test Your WiFi Access Restrictions

Use the following sections to ensure that your WiFi networks are set up correctly.

8.4.7.1 Check Settings

Take the following steps to check that the Zyxel Device is using the correct SSIDs, MAC filters and layer-2 isolation profiles.

- 1 Click **Configuration > Wireless > AP Management**. Check that the correct SSID profiles are enabled, as shown in the following figure.

Figure 66 SSID Profiles Enabled

#	SSID Profile	Band	
1	Wiz_SSID_1	2.4G/5G	
2	Wiz_SSID_2	2.4G/5G	
3	disable		

- 2 Next, go to **Configuration > Object > AP Profile**. Check that each configured SSID profile uses the correct **Security, Layer-2 Isolation** and **MAC Filter** profiles, as shown in the following figure.

Figure 67 SSID Tab Correct Settings

#	Profile Na...	SSID	Security Profile	QoS	MAC Filtering Profile	Layer-2 Isolation P...	VLAN ID
1	Wiz_SSID_1	SERVE...	Wiz_SEC_Profile_1	W...	MacFilter_SERVER_1	L2-ISO_SERVER_1	1
2	Wiz_SSID_2	SERVE...	Wiz_SEC_Profile_2	W...	MacFilter_SERVER_2	L2-ISO_SERVER_2	1
3	Wiz_SSID_3	Zyxel	Wiz_SEC_Profile_3	W...	disable	disable	1
4	Wiz_SSID_4	Zyxel	Wiz_SEC_Profile_4	W...	disable	disable	1
5	Wiz_SSID_5	Zyxel	Wiz_SEC_Profile_5	W...	disable	disable	1
6	Wiz_SSID_6	Zyxel	Wiz_SEC_Profile_6	W...	disable	disable	1
7	Wiz_SSID_7	Zyxel	Wiz_SEC_Profile_7	W...	disable	disable	1
8	Wiz_SSID_8	Zyxel	Wiz_SEC_Profile_8	W...	disable	disable	1
9	default	Zyxel-...	default	W...	disable	disable	1

8.4.7.2 Testing the Access Restrictions

Before you allow employees to use the network, you need to thoroughly test whether the setup behaves as it should. Take the following steps to do this.

- 1 Test the SERVER_1 network.
 - Using Alice's computer and WiFi client, and the correct security settings, do the following.
 - Attempt to access Server 1. You should be able to do so.
 - Attempt to access the Internet. You should be able to do so.
 - Attempt to access Server 2. You should be unable to do so. If you can do so, layer-2 isolation is misconfigured.
 - Using Alice's computer and WiFi client, and incorrect security settings, attempt to associate with the SERVER_1 network. You should be unable to do so. If you can do so, security is misconfigured.
 - Using another computer and WiFi client, but with the correct security settings, attempt to associate with the SERVER_1 network. You should be unable to do so. If you can do so, MAC filtering is misconfigured.
- 2 Test the SERVER_2 network.
 - Using Bob's computer and WiFi client, and the correct security settings, do the following.

Attempt to access Server 2. You should be able to do so.

Attempt to access the Internet. You should be able to do so.

Attempt to access Server 1. You should be unable to do so. If you can do so, layer-2 isolation is misconfigured.

- Using Bob's computer and WiFi client, and incorrect security settings, attempt to associate with the SERVER_2 network. You should be unable to do so. If you can do so, security is misconfigured.
- Using another computer and WiFi client, but with the correct security settings, attempt to associate with the SERVER_2 network. You should be unable to do so. If you can do so, MAC filtering is misconfigured.

If you cannot do something that you should be able to do, check the settings as described in [Check Settings](#), and in the individual Security, layer-2 isolation and MAC filter profiles for the relevant network. If this does not help, see the Troubleshooting chapter in this User's Guide.

8.5 Device Settings

In this section, we show you how to:

- [Change the Management IP Address](#)
- [Change the System Name](#)
- [Change the Login Password](#)

8.5.1 Change the Management IP Address

Change the management IP address of the Zyxel Device to ensure it does not duplicate the IP address of any other device on the network. If IP addresses are duplicated, you may be unable to access the Zyxel Device.

- 1 Set the computer's IP address to be in the same subnet as the Zyxel Device. For example, the default static management IP address of the Zyxel Device is 192.168.1.2. Make sure your computer's IP address is from 192.168.1.3~192.168.1.254.

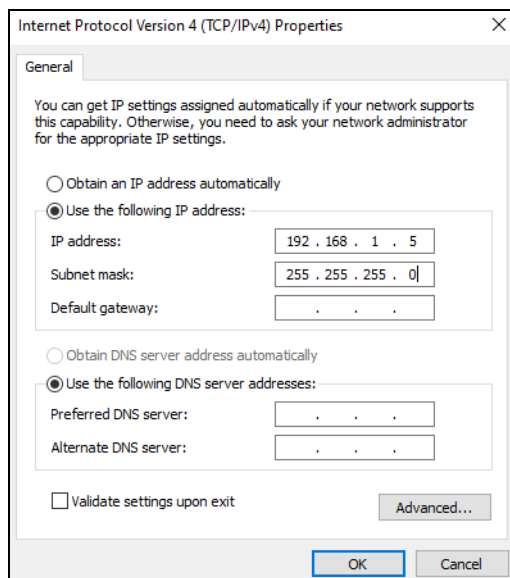

- Go to the **Configuration > Network > IP Setting** screen in the Web Configurator. Select the **IP type** to **Static IP** and specify a preferred IPv4 address in the **IP Address** field, for example, "192.168.1.10". After clicking **Apply**, you will be disconnected from the Web Configurator due to the IP address change.

IP Address Assignment

IP type: Static IP

IP Address: 192.168.1.10

Subnet Mask: 255.255.255.0

Gateway: (Optional)

DNS Server IP Address: (Optional)

IPv6 Address Assignment

Enable Stateless Address Auto-configuration (SLAAC)

Link-Local Address: fe80::4aed:e6ff:fe37:a248/64

IPv6 Address/Prefix Length: (Optional)

Gateway: (Optional)

Metric: (0-15)

DHCPv6 Client

DUID: 00:03:00:01:48:ed:e6:37:a2:4e

Request Address

DHCPv6 Request Options

DNS Server

NTP Server

Apply **Reset**

- To check if the IP address of the Zyxel Device has been changed to "192.168.1.10", enter the new IP address "192.168.1.10" in the address bar and see if you can log in to the Web Configurator successfully. Ensure that your computer's IP address is in the same subnet as the Zyxel Device. For example, if the management IP address of the Zyxel Device is "192.168.1.10", your computer's IP address should be from 192.168.1.3~192.168.1.254.

8.5.2 Change the System Name

Changing the system name ensures that the Zyxel Device's name is not duplicated with other devices on the network, which may otherwise cause confusion for network administrators.

- Go to the **Configuration > System > Host Name** screen and enter a new name with 1 to 64 alphanumeric characters in the **System Name** field. Spaces are not allowed. Click **Apply** to save your changes.

General Settings

System Name: NWA130BE_alice (Optional)

System Location: (Optional)

Domain Name: (Optional)

Apply **Reset**

- See the **System Name** field in the **Dashboard** screen to check if the new system name has been applied.

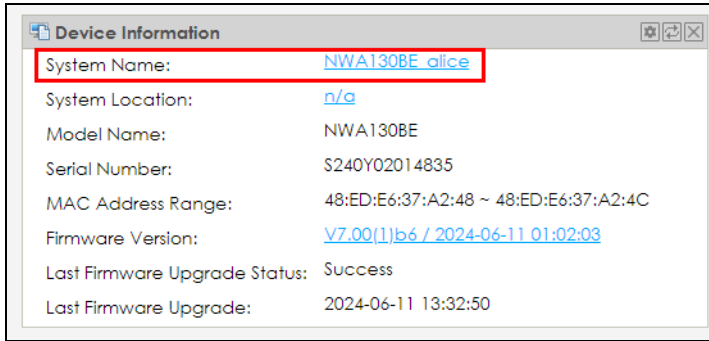

8.5.3 Change the Login Password

Change the Web Configuration login password to help secure your account.

- 1 Go to the **Configuration > Object > User** screen. Select an account and click the **Edit** icon.

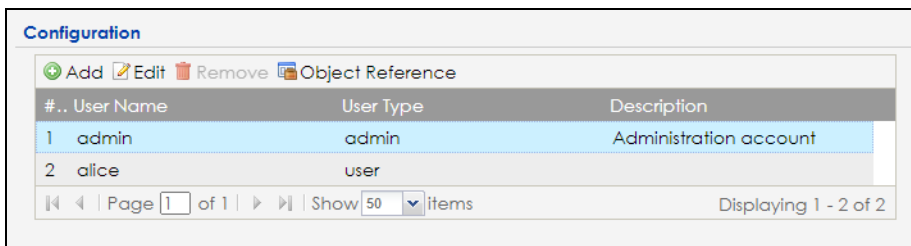

- 2 The **Edit User admin** screen appears. Enter the new password with 4 to 63 characters. Spaces are not allowed. Reenter the new password and click **OK**.

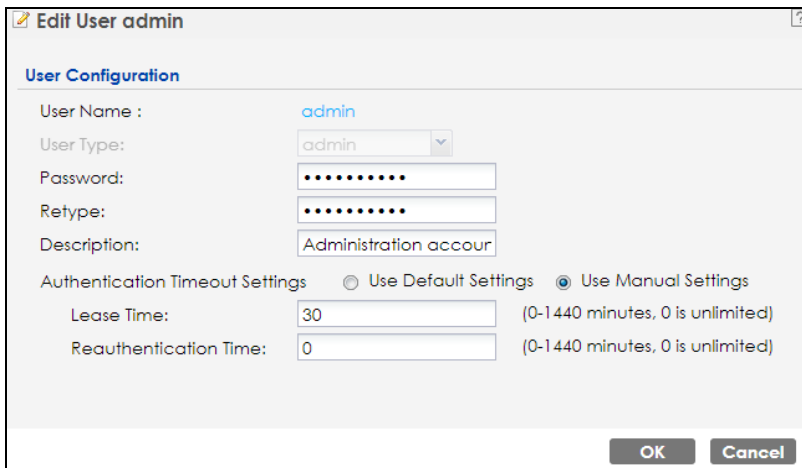

8.6 Device Management Using Nebula

In this section, we will show you how to:

- [Create a Zyxel Account on the NCC Portal](#)

- Register your Zyxel Device on the NCC Portal
- Create a Zyxel Account with the Zyxel Nebula Mobile App
- Register your Zyxel Device with the Zyxel Nebula Mobile App

8.6.1 Create a Zyxel Account on the NCC Portal

- 1 Go to the NCC portal in one of two ways.
 - Enter <https://nebula.zyxel.com> in a supported web browser. See the Nebula User's Guide for more information about supported browsers.



- Click the **Nebula Control Center** icon in the upper right of the Zyxel Device's Web Configurator.

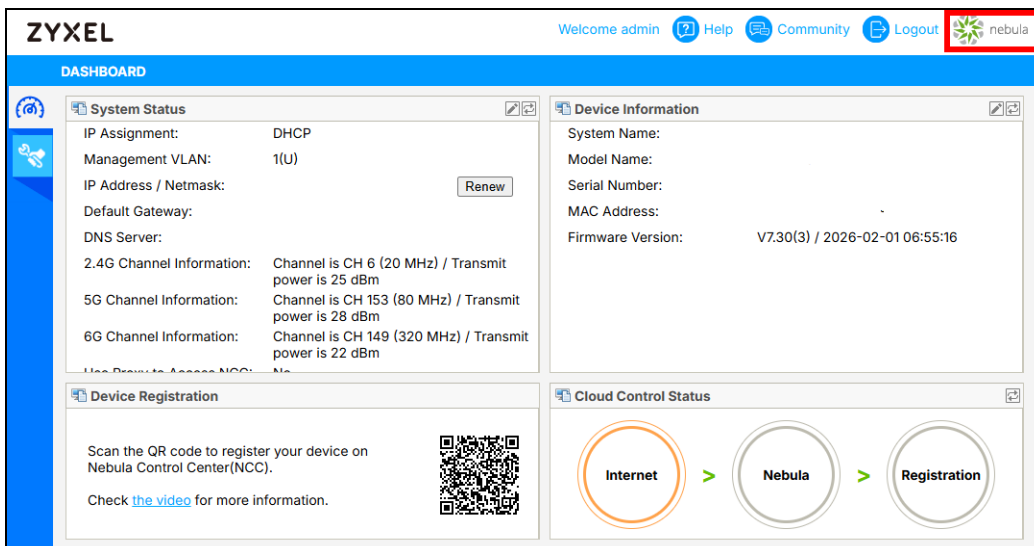

- 2 Click **Get Started** in the NCC portal.



- 3 Click **Create an account** and you will be redirected to another screen where you can sign up for a ZyXel Account.

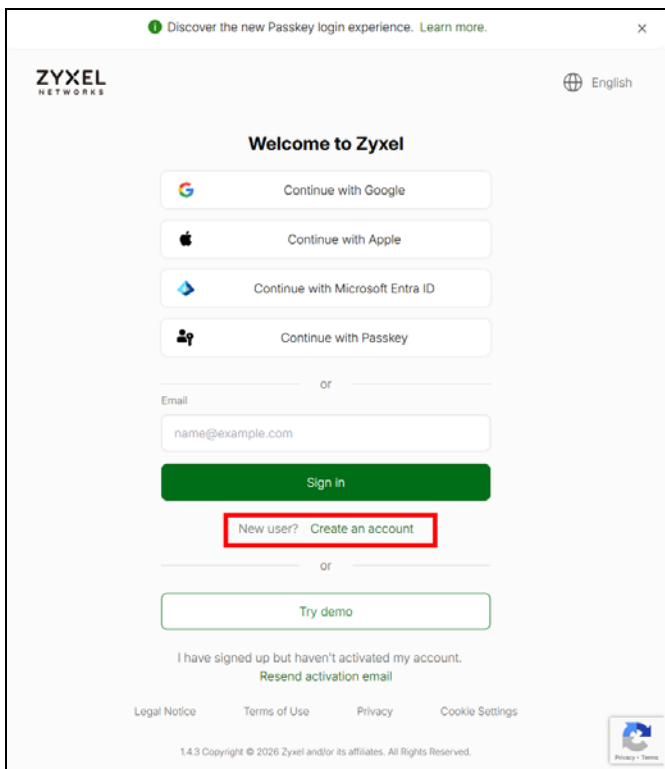

- 4 Enter your **First name, Last name, Email, Country/Region,** and **Contact person.** Select the checkbox to receive future information from ZyXel. Click **Create Account.**

The screenshot shows the Zyxel account creation page. The form is titled "Create an account" and includes the following fields: "First name" (Alicia), "Last name" (Tang), "Email" (Alicia.zyxel.com.tw), "Country/Region" (Taiwan), and "Contact person" (name@example.com). A checkbox is checked, indicating the user wants to receive communications from Zyxel. A green "Create account" button is visible below the form. The page also includes a "Sign in" link for existing users and a "Resend activation email" link for users who have signed up but not activated their account. The Zyxel logo and "English" language selector are in the top left and right corners, respectively. The footer contains the copyright notice: "1.4.3 Copyright © 2026 Zyxel and/or its affiliates. All Rights Reserved."

- 5 A notification informs you that a confirmation email will be sent to the registered email address on the NCC portal.

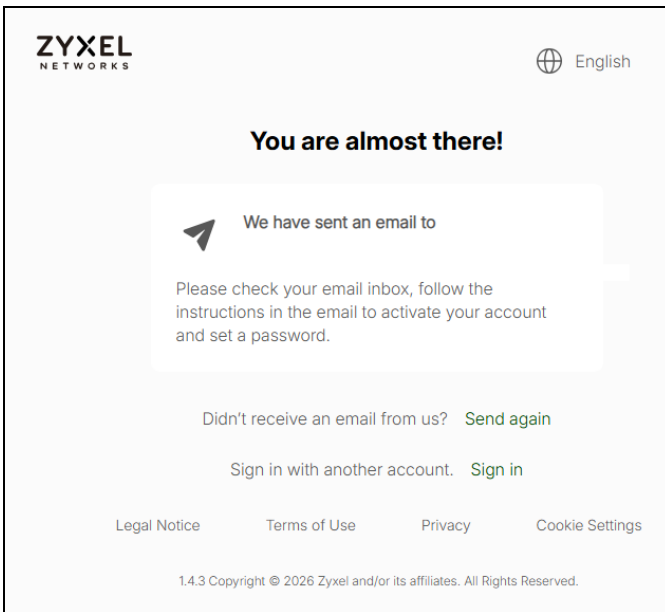

- 6 Check your email inbox. You will receive an email as shown below. Your new Zyxel Account has been created.

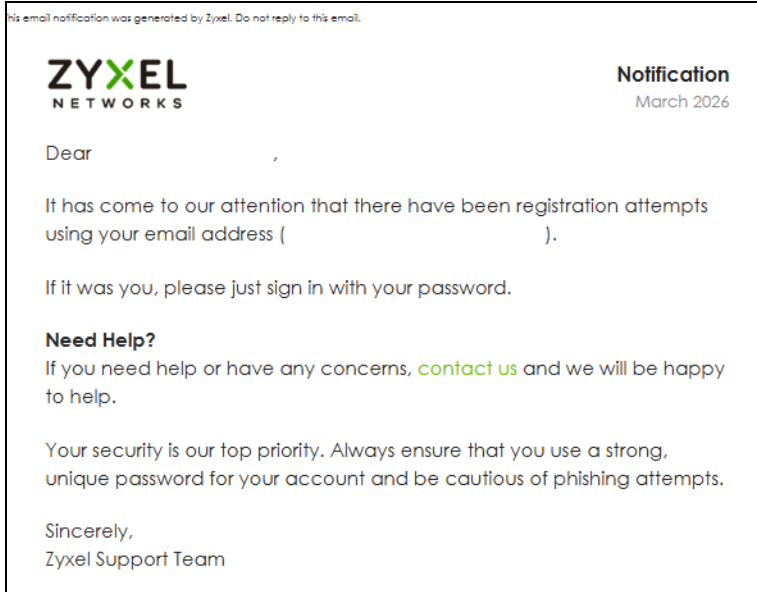

- 7 Go to the NCC portal and click **Get Started**.



- 8 Enter your email address, and click **Sign in** to log in to the NCC portal with your new Zyxel Account and password.

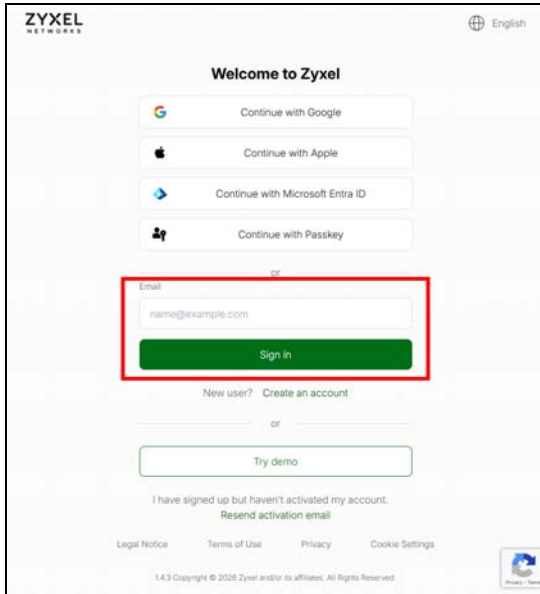

8.6.2 Register your Zyxel Device on the NCC Portal

Go to the NCC portal. Enter your existing Zyxel Account credentials, or log in using a social account such as **Google**, **Apple**, **Microsoft Entra ID**, or **Passkey**. Then, click **Sign in**.

If this is your first time logging in to the NCC portal, see [First-Time Login to the NCC Portal](#).

If this is not your first time logging in to the NCC portal, see [Regular Login to the NCC Portal](#).

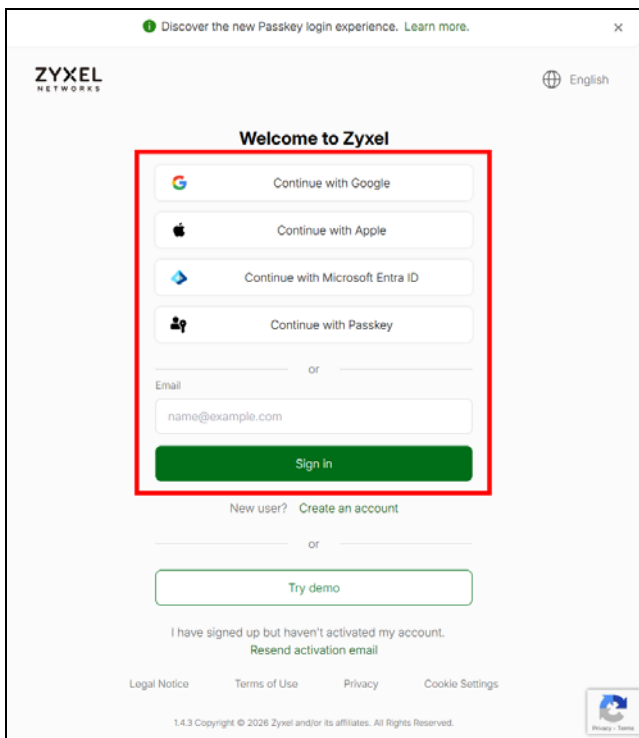

First-Time Login to the NCC Portal

- Follow the Nebula setup wizard to create an organization and site.
 - The setup wizard helps you create an organization and site, add Nebula Devices, upgrade your Nebula Device firmware, and set up WiFi networks quickly.
 - The wizard appears automatically after you log in the first time or if there is no organization created under your account.
 - The wizard also starts when you click **Create organization** from the **Organization** drop-down list in the title bar.
- Enter the **Organization** and **Site names**. Select your **Country** and **Time zone**. Click **Next**.

The screenshot shows the first step of the Nebula setup wizard. On the left, there is instructional text: "01 With Nebula Control Center, you can efficiently manage multiple USG FLEX H firewalls along with other Zyxel devices in a single window, including on/off monitoring, firmware management, configuration backup/restore, and accessing the remote GUI. To register your USG FLEX H firewall with Nebula, please provide your Organization and Site names. You organize Zyxel devices in Nebula into Organizations, for example, "YourCompany" or "YourClient", and Sites, for example, "London Branch" or "Factory".

The main area is titled "First step is to create your Organization and Site" and contains a form with the following fields:

- Organization: Zyxel
- Site: Alicia
- Country: Taiwan
- Time zone: Asia - Taipei (UTC +8:0)

 A green "Next" button is located below the form. A red box highlights the entire form area.

- Enter the **MAC address**, **Serial number**, and **Name** of the **Zyxel Device**. Click the **Add** icon , then click **Next**.

The screenshot shows the second step of the Nebula setup wizard. On the left, there is instructional text: "02 To add your device(s) you will need to input the MAC address, which is the number that looks like this: 7C:99:DD:39:AC:F0, and the Serial Number that looks similar to: S891345239054. These are located on the box and at the bottom of each device, it may appear as:"

Below the text is a diagram of a device with labels for "Serial Number" and "MAC address".

The main area is titled "Let's now add your device(s) to Nebula" and contains a table with the following columns:

MAC address	Serial number	Name	Model
<input type="text"/>	<input type="text"/>	<input type="text"/>	<input type="text"/>

 A red box highlights the input fields in the table. Below the table are "Back" and "Next" buttons. A green "Add" button with a plus icon is also visible. A red box highlights the "Add" button.

- Select the trial license applicable to your Zyxel Device. You can also click **Activate All** to use all trial licenses. When finished, click **Next**.

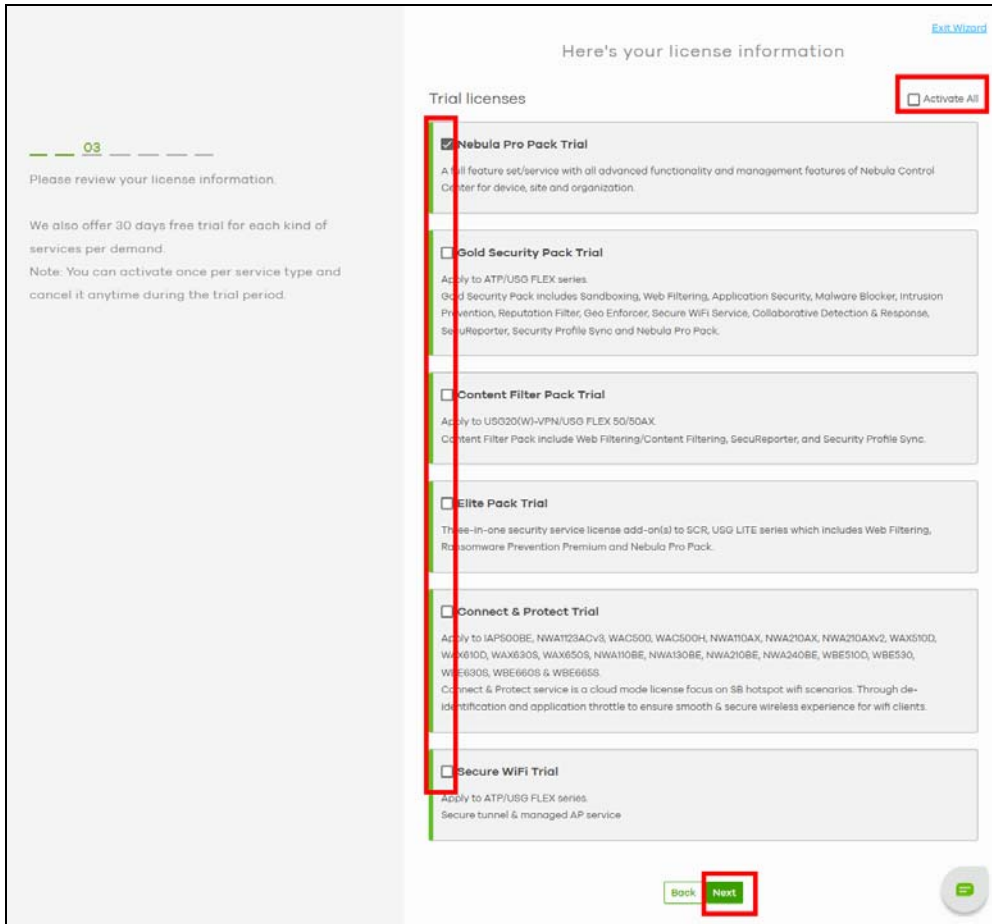

- Check if the **Organization summary** and **Devices** information are correct. Once finished, click **Go to Nebula Dashboard**. Your Zyxel Devices are now registered on the NCC portal.

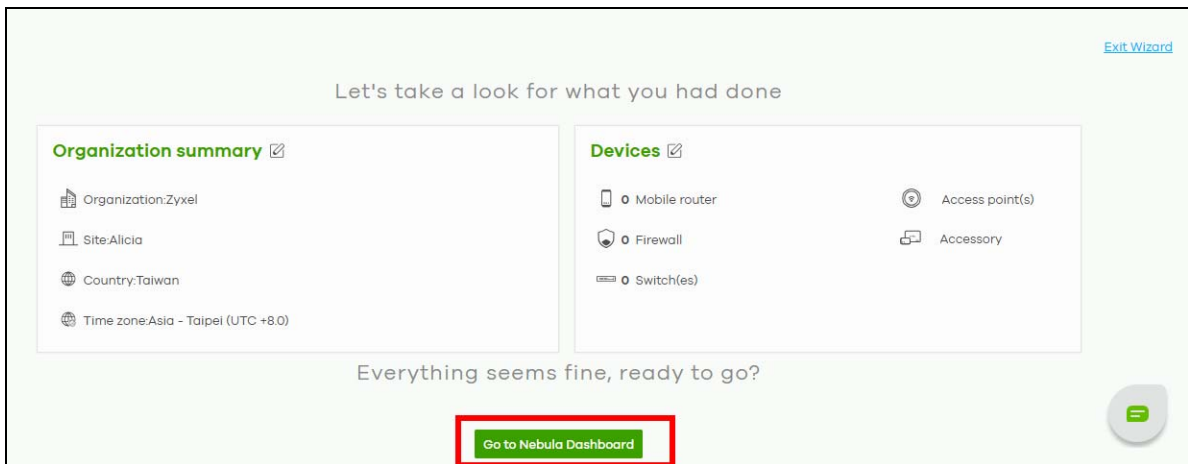

Regular Login to the NCC Portal

- 1 Select the **Organization** and **Site** where you want to register the Zyxel Device from the drop-down list at the top of the **Dashboard** screen.

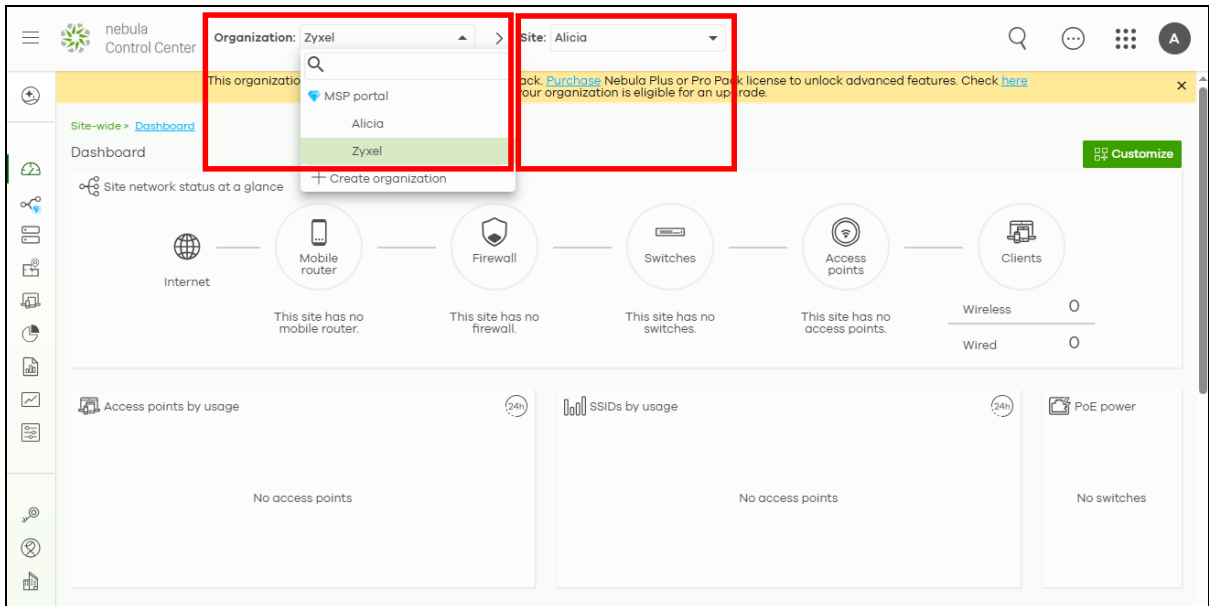

- 2 Click the **Devices** icon on the left-hand bar of the **Dashboard** screen. Click the **Add** icon **+** to register a Zyxel Device.

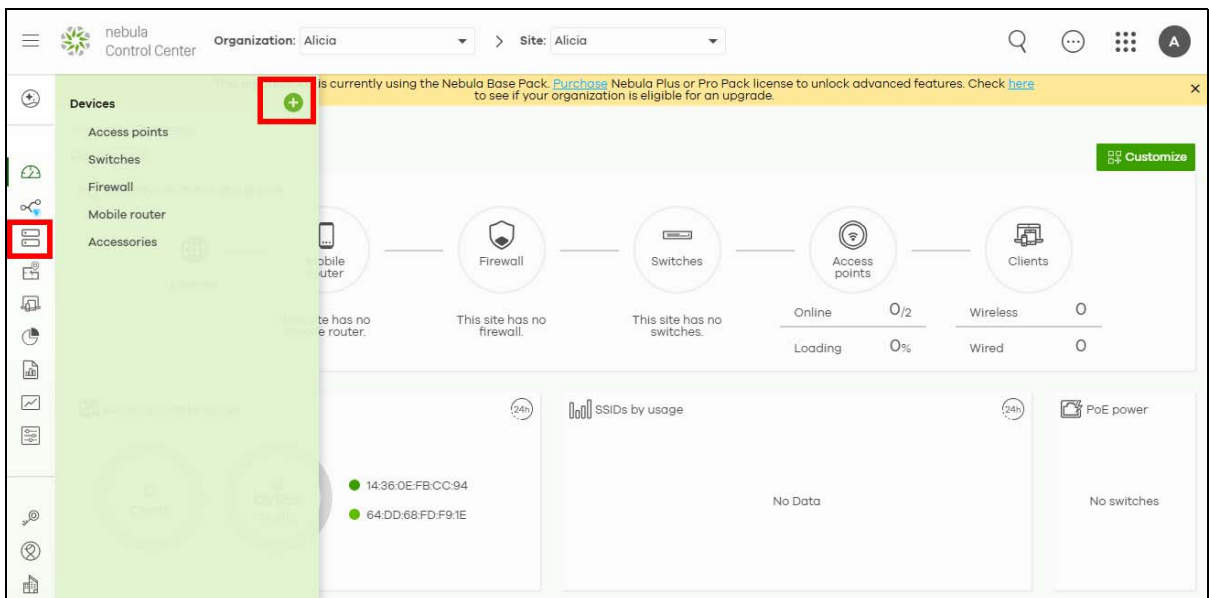

- 3 Click the **+Add** button on the right in the **Add devices** screen.

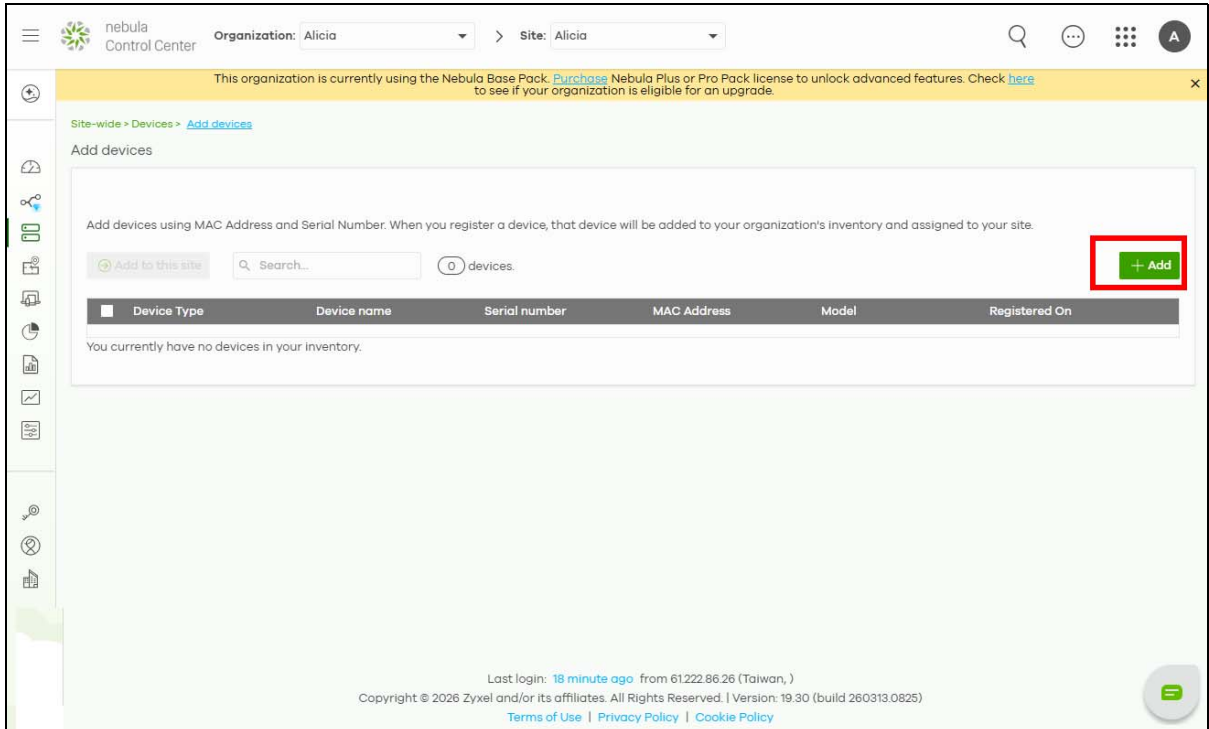

- 4 Enter the **MAC address**, **Serial number**, and **Name** of the Zyxel Device. The **Serial number** and Registration **MAC address** can be found on the **Dashboard** screen or on the device back label on the Zyxel Device. Click the **Add another device** button to add more devices if needed. When finished, click **Next**.

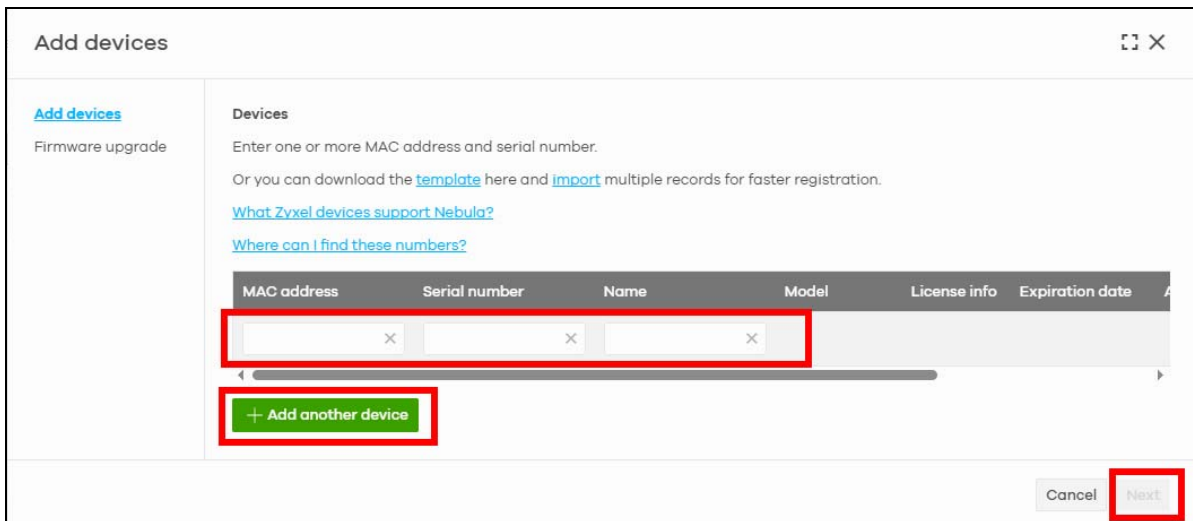

- 5 Select **Yes** to upgrade the Zyxel Device to the latest firmware. Click **Finish** to complete the registration of the Zyxel Device.

Add devices

Add devices
[Firmware upgrade](#)

Firmware upgrade
If a newer firmware is available, do you want to upgrade it during the device registration?
The upgrade may take a few minutes. Please check the LED status on your device(s).

Yes
 No

Cancel Previous **Finish**

- 6 An email will be sent to inform you that the Zyxel Device has been successfully registered on the NCC portal.

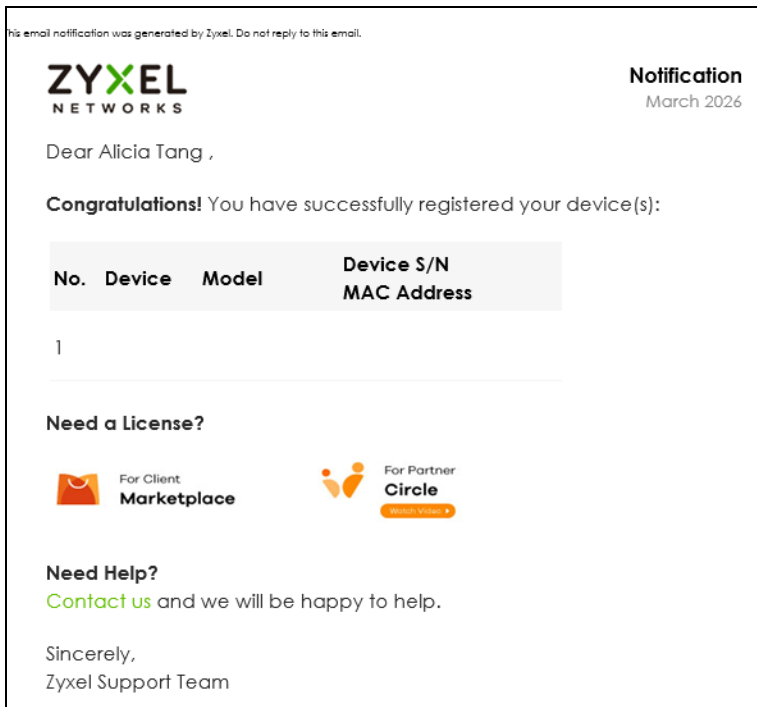

8.6.3 Create a Zyxel Account with the Zyxel Nebula Mobile App

Download and open the Zyxel **Nebula Mobile** app in your mobile device (see [Dashboard > Cloud Control Status](#) to download the app.)

- 1 Tap **Start**.

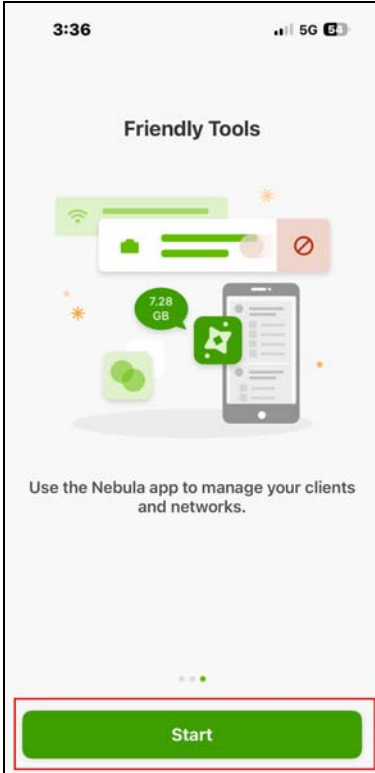

- 2 Tap **Create an account**. To return to the initial screen, tap the close icon in the upper-left corner.

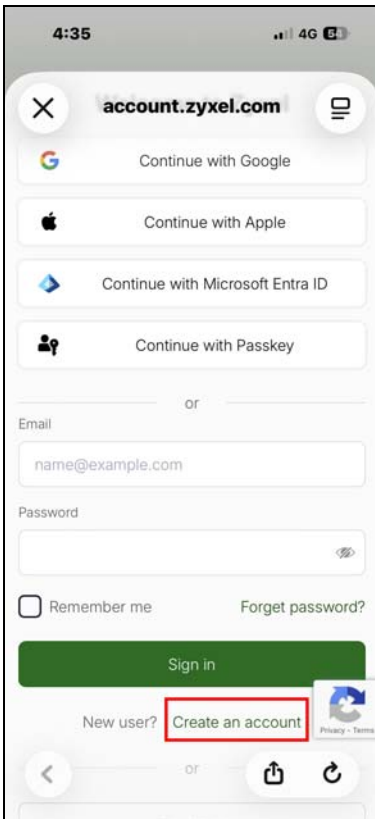

- 3 Enter your **First name**, **Last name**, **Email**, **Country/Region**, and **Contact person**. Select the checkbox to receive future information from Zyxel. Tap **Create account**.

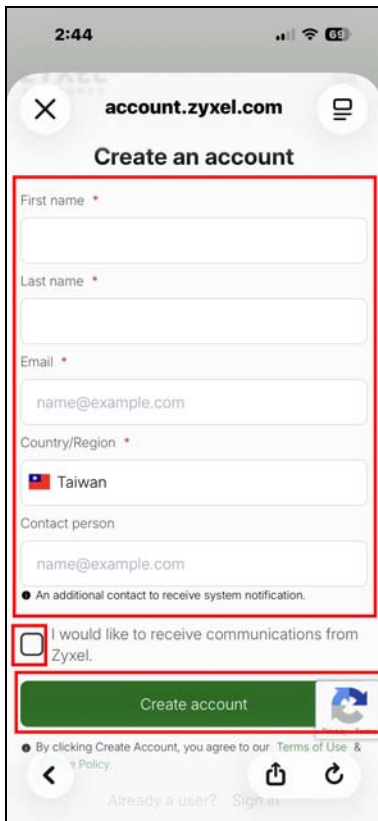

The screenshot shows the 'Create an account' form on the Zyxel mobile app. The form fields are: First name, Last name, Email (pre-filled with 'name@example.com'), Country/Region (pre-filled with 'Taiwan'), and Contact person (pre-filled with 'name@example.com'). A checkbox for 'I would like to receive communications from Zyxel.' is present and unchecked. A green 'Create account' button is at the bottom. The form is highlighted with a red border.

- 4 A notification informs you that a confirmation email will be sent to the registered email address on the NCC portal.

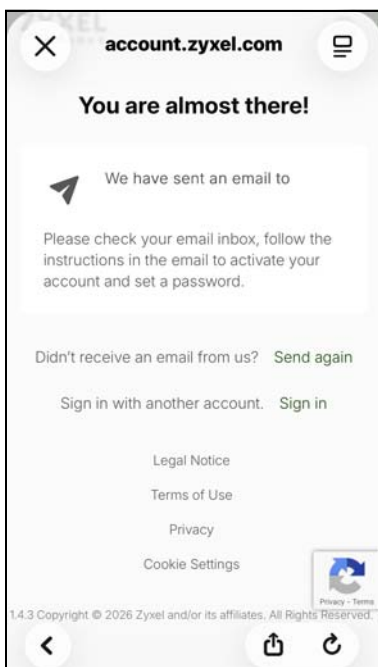

- 5 Check your email inbox. You will receive an email as shown below. Tap **Activate Account**. Your new Zyxel Account has been created.

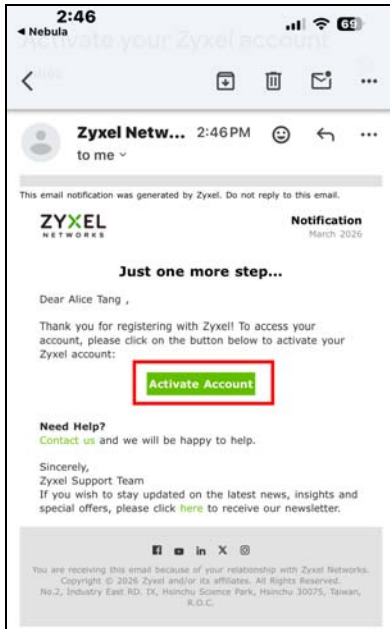

- 6 You will be prompted to choose an authentication method for your Zyxel Account in the **Nebula Mobile** app. Choose **Passkeys** to use fingerprint, Face ID, or PIN for authentication. Choose **Password** to set your own password for the Zyxel Account.

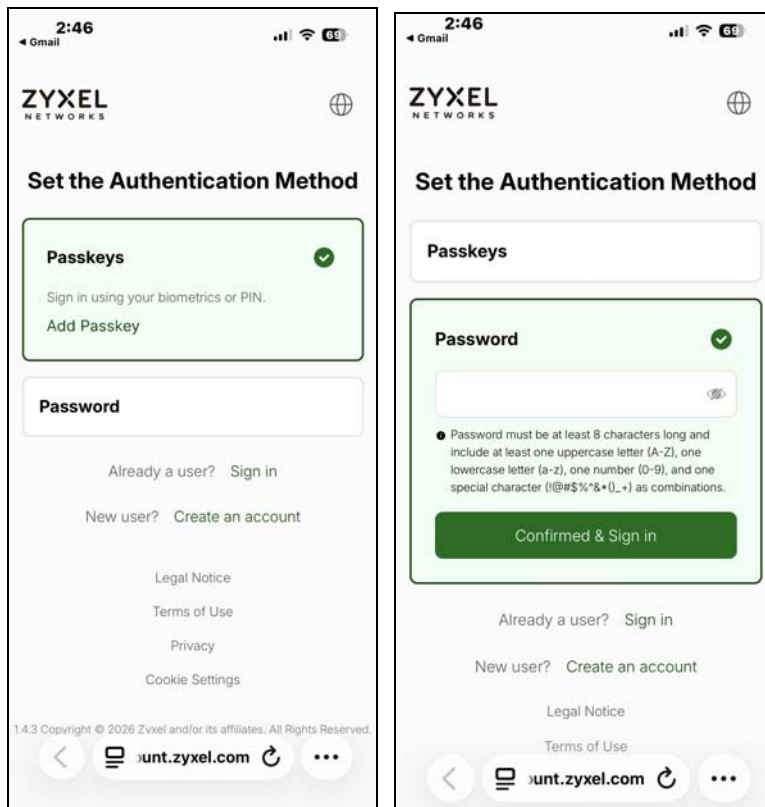

Passkeys

Tap **Add Passkey**. A notification prompts you to confirm adding the passkey. The example below uses Face ID as the passkey. For more details about passkeys, please refer to [Zyxel Account Authentication](#).

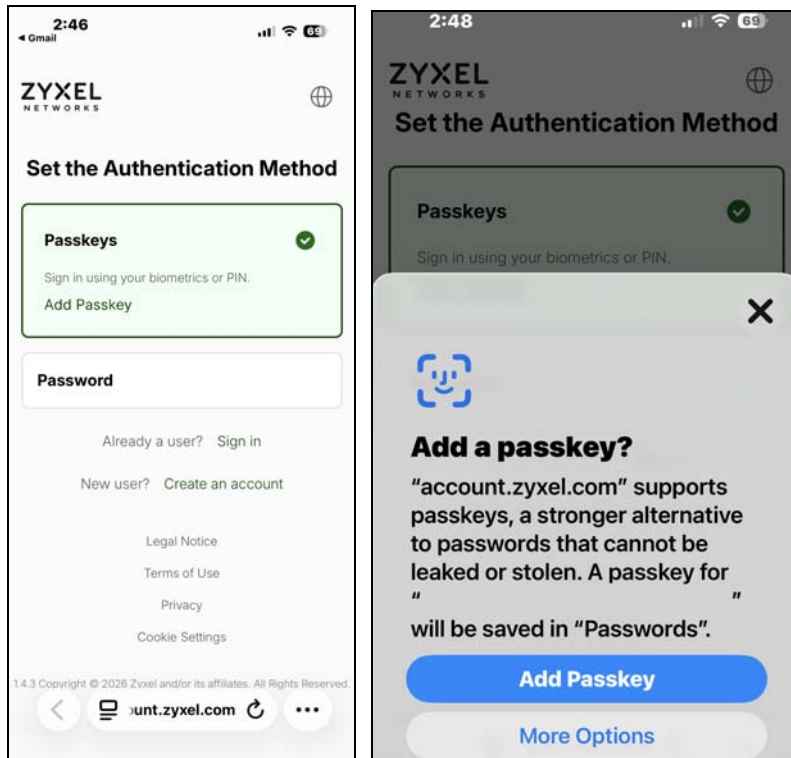

Password

Enter the password and tap **Confirmed & Sign in**.

Note: Use up to 8 single-byte characters for the **Password**, including at least one uppercase letter (A-Z), one lowercase letter (a-z), one number (0-9), and the following characters within the square brackets: [!@#\$\$%^&*()_+] as combinations.

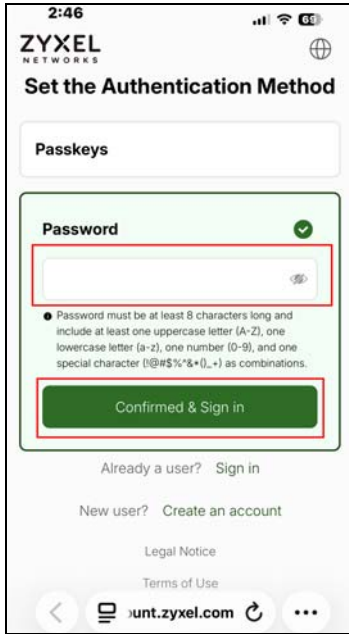

- 7 After setting the authentication method, the **Nebula Mobile** app prompts you to enable two-factor authentication. Tap **Enable now** to activate the feature, or tap **Remind me later** or **Skip** to close the screen.

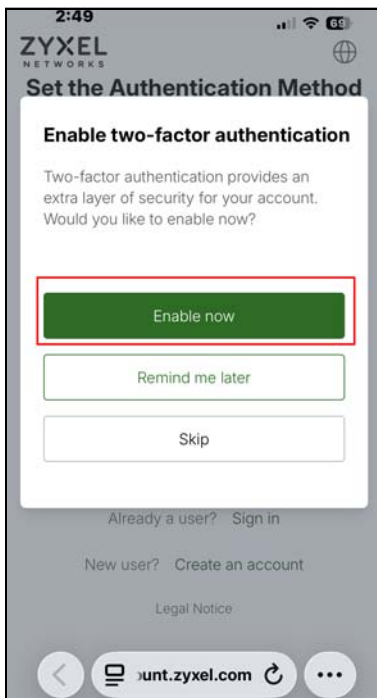

- 8 Choose either the **Google Authenticator** or **Email authentication** for the **Two-factor authentication**.

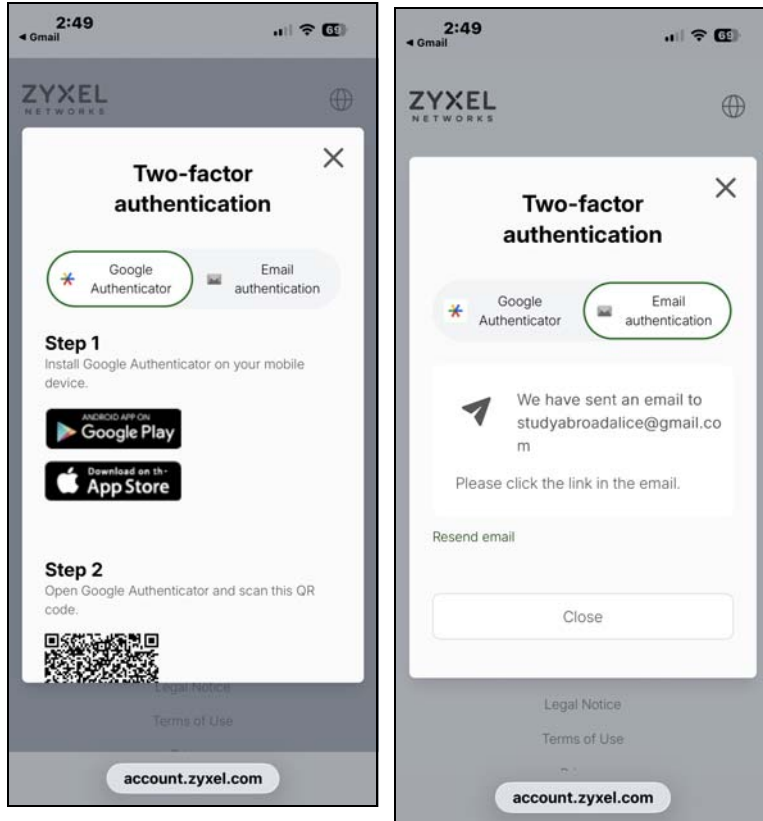

Google Authenticator

Follow the on-screen instructions to install the **Google Authenticator**. Scan the QR code with **Google Authenticator** and enter the code the **Google Authenticator** generates. Tap **Verify** to complete the authentication.

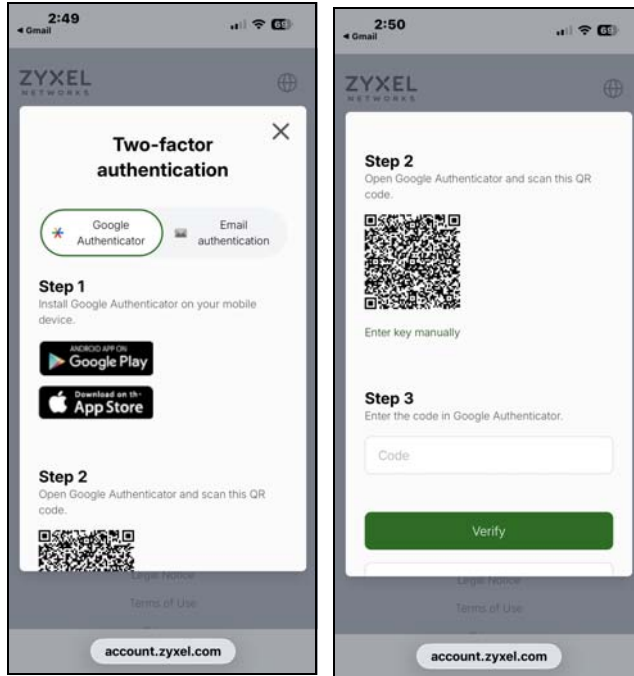

Email Authentication

Check your email inbox. Tap **Enable 2FA** to activate the setting of Two-factor email authenticator. Tap **Close** to complete the process.

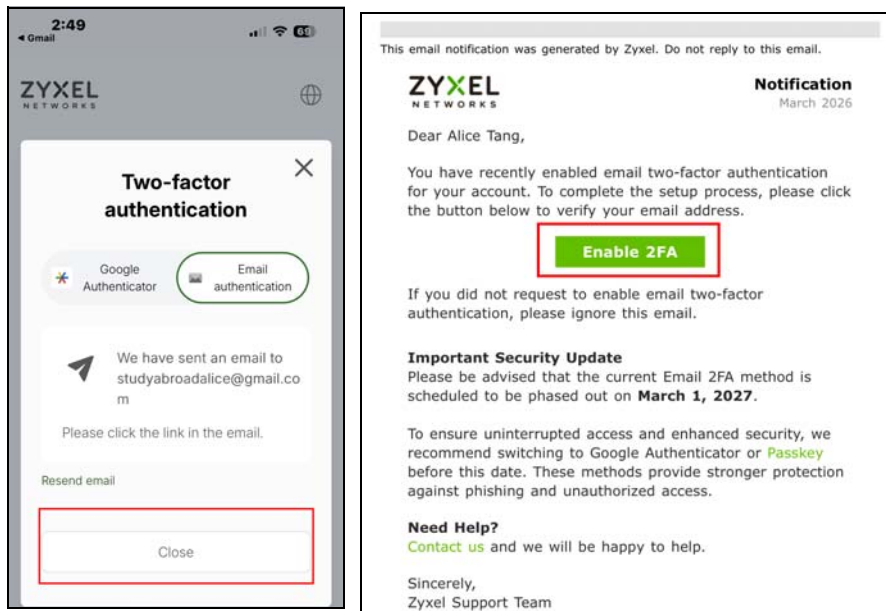

- 9 The **Nebula Mobile** app's dashboard appears. You have successfully created a ZyXel Account.

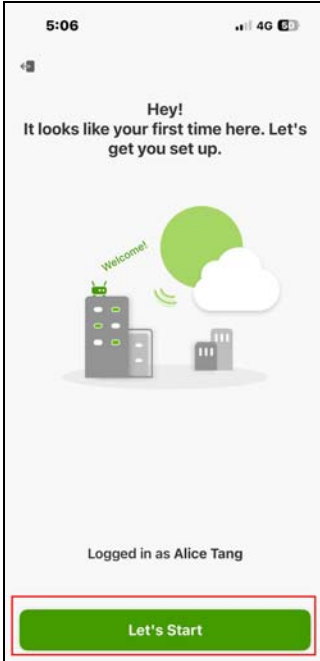

8.6.4 Register your Zyxel Device with the Zyxel Nebula Mobile App

- 1 Open the **Nebula Mobile** app and tap **Start**.

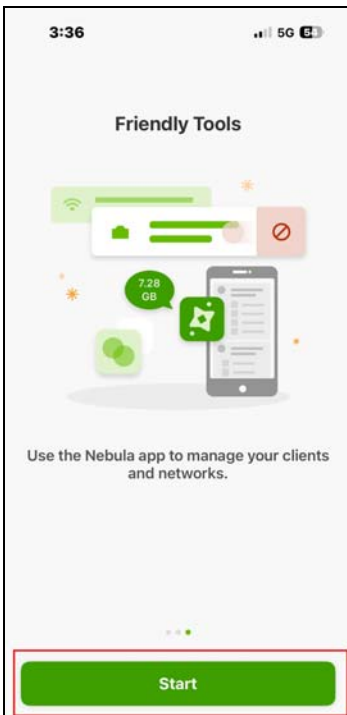

- 2 Log in to the **Nebula Mobile** app using any of the following methods:
 - with a Google, Apple, or Microsoft Entra ID account
 - with a passkey

- by entering your existing account information

Tap **Sign in**.

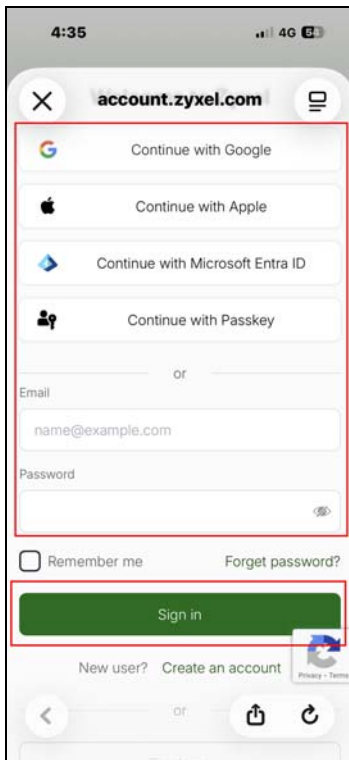

- 3 Tap **Let's Start** to create your first site on the **Nebula Mobile** app.

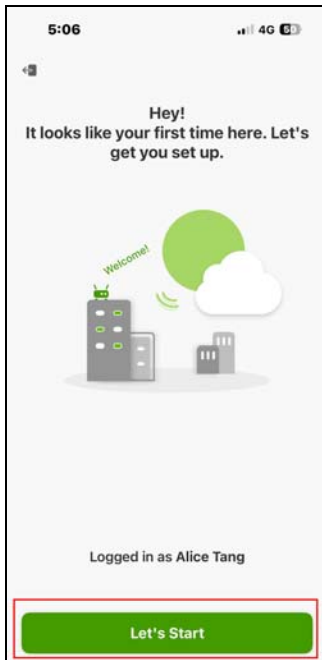

- 4 Enter your **Site Name**. An organization with the same name will be created automatically. Select your **Country & Timezone** from the drop-down list. The **Timezone** will adjust automatically based on the **Country** you select. Tap **Create**.

Note: For the **Site Name**, enter a descriptive name for identification purposes. Use up to 64 single-byte characters, including the following characters within the square brackets: [0-9a-zA-Z_~!@#\$%&*(_+~{}|[];"/.<> ?].



The screenshot shows a mobile application interface titled "Create Your First Site". At the top, the time is 5:06 and the signal strength is 4G. Below the title is a back arrow. The form consists of three main sections: 1. "Site Name" with a text input field containing "Alicia". 2. "Country & Timezone" with a dropdown menu currently showing "Taiwan" and a right-pointing chevron. Below the dropdown, the selected option "Asia - Taipei(UTC +8.0)" is visible. 3. A green "Create" button at the bottom of the form. Red rectangular boxes are drawn around the "Alicia" text, the "Taiwan" dropdown, and the "Create" button.

- 5 Add your Zyxel Device by scanning the QR code, or tap **Enter Manually** to enter the **Serial Number** and **MAC Address** from the Zyxel Device label. You can find the QR code:
 - On a label on the Zyxel Device or
 - On its box or
 - In the Web Configurator at [Dashboard > Cloud Control Status](#).

If you add a Zyxel Device manually, tap **Check** to confirm that the **Serial Number** and **MAC Address** are correct. After adding the Zyxel Device using either method, tap **Next**. If you do not want to add a Zyxel Device now, tap **Skip**.

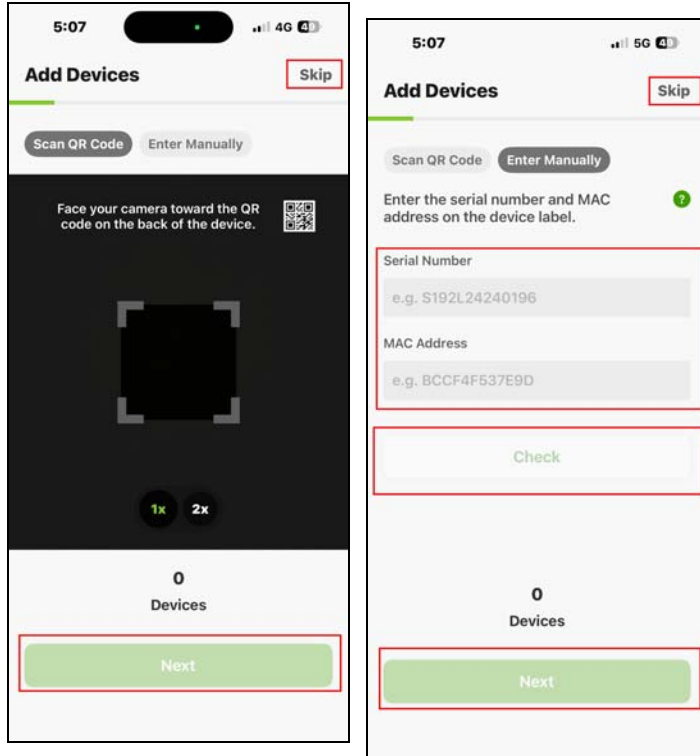

- 6 Select a trial license pack and tap **Next**. Refer to [License Finder](#) if you are unsure which license pack to choose.

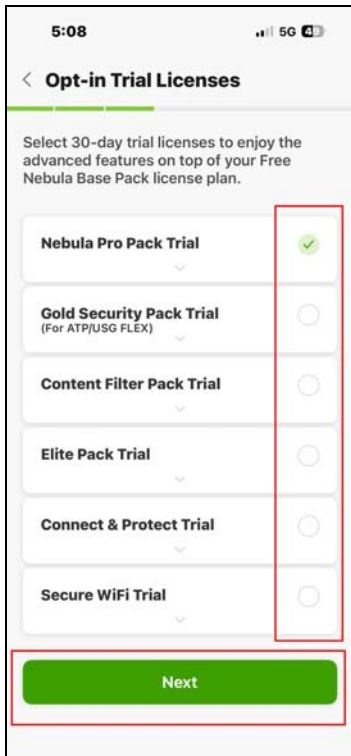

- 7 Tap **Enter Dashboard**.

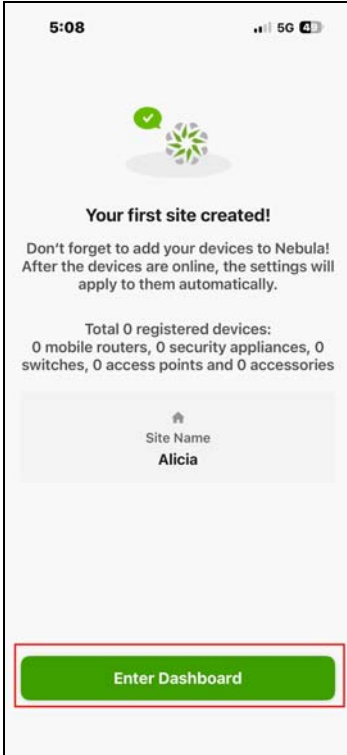

- 8 The **Dashboard** appears. The Zyxel Device has been successfully registered on the **Nebula Mobile** app.

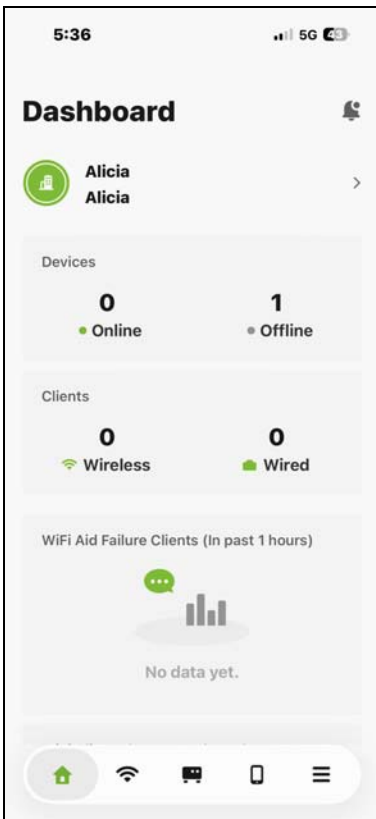

8.7 Device Maintenance

In this section, we show you how to:

- [Upgrade the Firmware](#)
- [Restore the Zyxel Device Configuration](#)

8.7.1 Upgrade the Firmware

Upload the firmware to the Zyxel Device for feature enhancements.

- 1 Download the correct firmware from the download library at the Zyxel website. The model code for the Zyxel Device in this example is ACIL. Unzip the file.
- 2 Go to **Maintenance > File Manager > Firmware Package** screen.
- 3 Click **Browse...** and select the file with a ".bin" extension to upload. Click **Upload**.

Version

Current Version: V7.00(1)b6
Released Date: 2024-06-11 01:02:03

Upload File

To upload firmware, browse to the location of the file (*.bin) and then click Upload.

File: **Browse...** **Upload**

Cloud Firmware Information

Latest Version: N/A **Check Now**

- 4 This process may take up to 2 minutes to finish. After 2 minutes, log on again and check your firmware version in the **Dashboard** screen.

8.7.2 Restore the Zyxel Device Configuration

The section shows you how to restore the configuration. You need to download and upload the configuration file to restore the configuration on the Zyxel Device.

Table 40 Configuration File Types

FILENAME	DESCRIPTION
autobackup-x.xx.conf	This is the configuration file that the Zyxel Device automatically backs up when upgrading the firmware.
startup-config.conf	This is the configuration file that the Zyxel Device is currently using.
system-default.conf	This is the Zyxel Device's default settings.
lastgood.conf	This is the most recently used (valid) configuration file that was saved when the Zyxel Device last restarted.

8.7.2.1 Download the Zyxel Device Configuration

You should regularly download your configuration especially before you make major configuration changes.

- 1 Go to the **Maintenance > File Manager > Configuration File** screen.
- 2 Under the **Configuration Files**, select **startup-config.conf** and click **Download**. The current configuration file that the Zyxel Device is using is saved to your computer. You can rename the configuration file to include the date you downloaded it. For example, **startup-config.conf_20240716**.

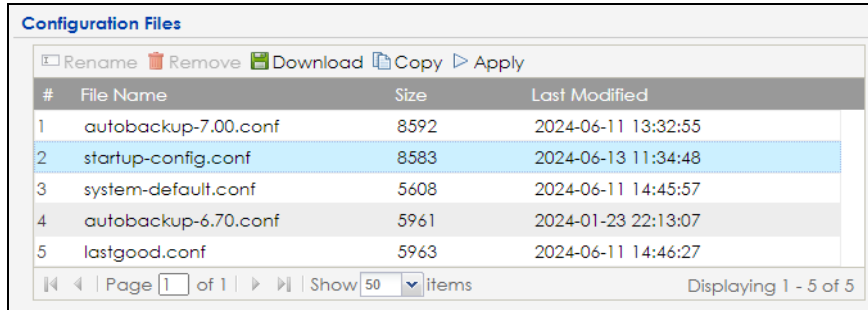

#	File Name	Size	Last Modified
1	autobackup-7.00.conf	8592	2024-06-11 13:32:55
2	startup-config.conf	8583	2024-06-13 11:34:48
3	system-default.conf	5608	2024-06-11 14:45:57
4	autobackup-6.70.conf	5961	2024-01-23 22:13:07
5	lastgood.conf	5963	2024-06-11 14:46:27

8.7.2.2 Upload the Zyxel Device Configuration

This section shows how to upload a previously saved configuration file from your computer to the Zyxel Device. You might need to do this to recover settings after a reset or to fix problems after configuration changes.

- 1 Go to the **Maintenance > File Manager > Configuration File** screen. Under **Upload Configuration File**, click **Browse...** and then select the configuration file that you saved. Click **Upload**.

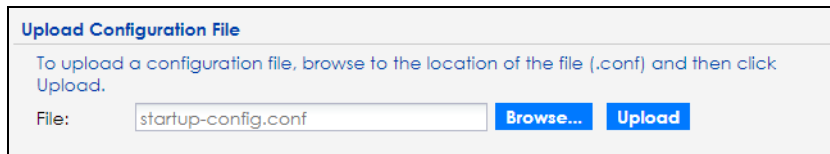

Upload Configuration File

To upload a configuration file, browse to the location of the file (.conf) and then click Upload.

File: **Browse...** **Upload**

- 2 You are logged out of the Web Configurator after the configuration file is successfully uploaded. Wait for one minute before logging into the Zyxel Device again.

8.8 Log and Report

In this section, we show you how to:

- [Back Up Logs to a Remote Server](#)

8.8.1 Back Up Logs to a Remote Server

Backing up logs to a remote server allows you to store large amounts of log data and prevent log data lost on your Zyxel Device. The Zyxel Device can keep at most 512 logs. If the logs exceed this number, the oldest logs will be lost.

- 1 Go to **Configuration > Log & Report > Log Setting**. Select a remote server to configure, and then click **Edit**.

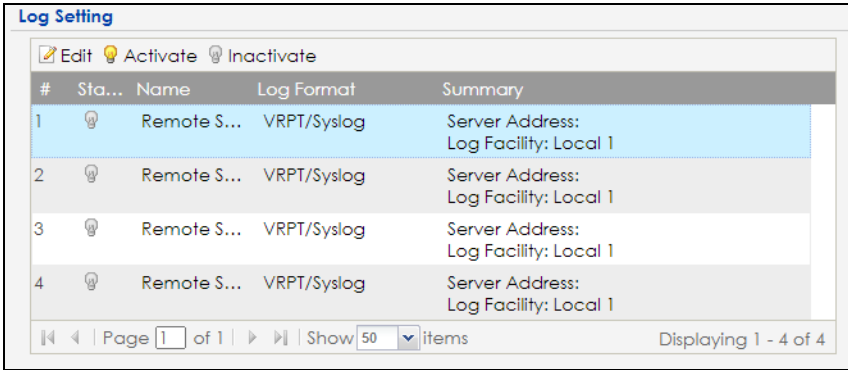

- 2 The following screen appears. Select **Active** and enter the IPv4 address or name of the remote server in the **Server Address** field to send the logs. Then, select a log facility. The log facility allows you to log the messages to different files in the syslog server. Please see the documentation for your syslog program for more information.

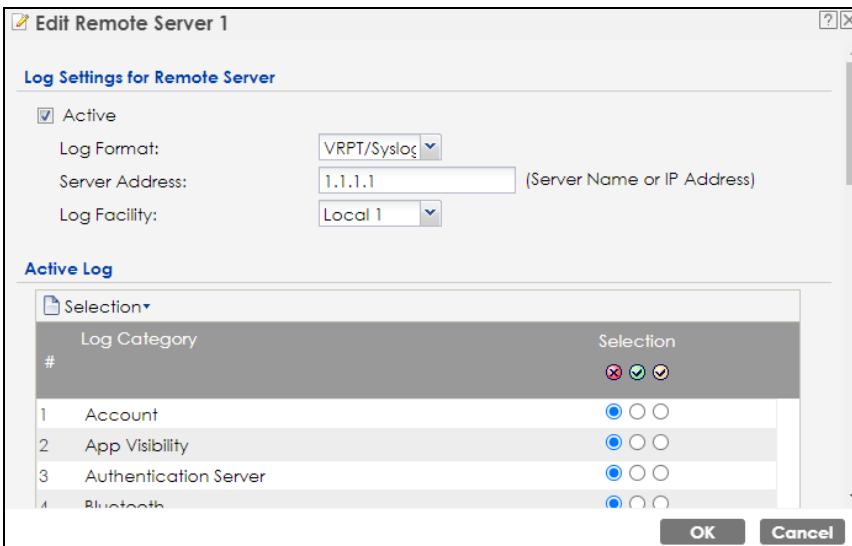

- 3 Select the type of logs you want to back up on the remote server. The following are the log settings represented by the icons.
- Red X - Do not send the remote server logs for any log category.
 - Green checkmark - Send the remote server log messages and alerts for all log categories.
 - Yellow checkmark - Send the remote server log messages, alerts, and debugging information for all log categories.

Edit Remote Server 1

Log Settings for Remote Server

Active

Log Format: VRPT/Syslog

Server Address: 1.1.1.1 (Server Name or IP Address)

Log Facility: Local 1

Active Log

Selection

#	Log Category	Selection
1	Account	<input checked="" type="radio"/> <input type="radio"/> <input type="radio"/>
2	App Visibility	<input checked="" type="radio"/> <input type="radio"/> <input type="radio"/>
3	Authentication Server	<input checked="" type="radio"/> <input type="radio"/> <input type="radio"/>
4	Bluetooth	<input checked="" type="radio"/> <input type="radio"/> <input type="radio"/>
5	Built-in Service	<input checked="" type="radio"/> <input type="radio"/> <input type="radio"/>
6	CAPWAP DataForward	<input checked="" type="radio"/> <input type="radio"/> <input type="radio"/>
7	Cloud Auth	<input checked="" type="radio"/> <input type="radio"/> <input type="radio"/>
8	Connectivity Check	<input checked="" type="radio"/> <input type="radio"/> <input type="radio"/>

OK Cancel

- 4 Click **OK** to save your changes.

8.9 Remote Access to the Zyxel Device

This section shows you how to configure WAN access for a specific trusted computer through HTTPS, HTTP or SSH to the Zyxel Device. Remote management determines which interface and web services are allowed to access the Zyxel Device.

Perform the following to find the options to configure remote access to your Zyxel Device.

HTTPS / HTTP

- 1 Go to the **Configuration > System > Service Control** screen. Select whether you want to access the Zyxel Device remotely through HTTPS or HTTP. Click **Apply** to save your changes.

The screenshot shows the 'Service Control' configuration page. It is divided into two sections: 'HTTPS' and 'HTTP'.
Under the 'HTTPS' section:
- There is a checked checkbox for 'Enable'.
- The 'Server Port' is set to '443'.
- There is an unchecked checkbox for 'Authenticate Client Certificates' with a link '(See [Trusted CAs](#))'.
- The 'Server Certificate' is set to 'default' in a dropdown menu.
- There is a checked checkbox for 'Redirect HTTP to HTTPS'.
Under the 'HTTP' section:
- There is a checked checkbox for 'Enable'.
- The 'Server Port' is set to '80'.
At the bottom of the page are two buttons: 'Apply' and 'Reset'.

Note: The HTTPS server listens on port 443 by default. If you change the HTTPS server port to a different number on the Zyxel Device, for example 8443, then you must notify people who need to access the Zyxel Device Web Configurator to use "https://Zyxel Device IP Address:8443" as the URL.

SSH

Go to the **Configuration > System > SSH** screen. Select whether you want to access the Zyxel Device remotely through SSH. Click **Apply** to save your changes. You may change the server port number for a service if needed, however you must use the same port number in order to use that service for remote management.

The screenshot shows the 'SSH' configuration page. It has a 'General Settings' section with the following options:
- A checked checkbox for 'Enable'.
- The 'Server Port' is set to '22'.
- The 'Server Certificate' is set to 'default' in a dropdown menu.
At the bottom of the page are two buttons: 'Apply' and 'Reset'.

CHAPTER 9

Monitor

9.1 Overview

Use the **Monitor** screens to check status and statistics information.

9.1.1 What You Can Do in this Chapter

- The **Network Status** screen ([Network Status](#)) displays general LAN interface information and packet statistics.
- The **AP Information > Radio List** screen ([Radio List](#)) displays statistics about the WiFi radio transmitters in the Zyxel Device.
- The **Station Info** screen ([Station List](#)) displays statistics pertaining to the associated stations.
- The **WDS Link Info** screen ([WDS Link Info](#)) displays statistics about the Zyxel Device's WDS (Wireless Distribution System) connections.
- The **Detected Device** screen ([Detected Device](#)) displays information about suspected rogue APs.
- The **View Log** screen ([View Log](#)) displays the Zyxel Device's current log messages. You can change the way the log is displayed, you can email the log, and you can also clear the log in this screen.

9.2 What You Need to Know

The following terms and concepts may help as you read through the chapter.

Rogue AP

Rogue APs are wireless access points operating in a network's coverage area that are not under the control of the network's administrators, and can open up holes in a network's security.

Friendly AP

Friendly APs are other wireless access points that are detected in your network, as well as any others that you know are not a threat (those from neighboring networks, for example).

9.3 Network Status

Use this screen to look at general Ethernet interface information and packet statistics. To access this screen, click **Monitor > Network Status**.

Figure 68 Monitor > Network Status

Network Status									
Interface Summary									
Name	Status	VID	IP Addr/Netmask	IP Assignment	Action				
UPLINK	1000M/Full	1		DHCP client	Renew				
IPv6 Interface Summary									
Name	Status	IP Address			Action				
UPLINK	1000M/Full	LINK LOCAL --			n/a				
Port Statistics Table									
Poll Interval:	<input type="text" value="5"/>	Seconds	Set Interval	Stop					
Switch To Graphic View									
Name	Status	TxPkts	RxPkts	Tx Bcast	Rx Bcast	Collisions	Tx	Rx	Up Time
UPLINK	1000M/Full	5490	40206	28	12604	0	0	635	01:43:51
LAN1	Down	0	0	0	0	0	0	0	00:00:00
System Up Time:		01:43:51							

The following table describes the labels in this screen.

Table 41 Monitor > Network Status

LABEL	DESCRIPTION
Interface Summary/IPv6 Interface Summary	Use the Interface Summary section for IPv4 network settings. Use the IPv6 Interface Summary section for IPv6 network settings if you connect your Zyxel Device to an IPv6 network. Both sections have similar fields as described below.
Name	This field displays the name of the physical Ethernet port on the Zyxel Device.
Status	This field displays the current status of each physical port on the Zyxel Device. Down - The port is not connected. Speed / Duplex - The port is connected. This field displays the port speed and duplex setting (Full or Half).
VID	This field displays the VLAN ID to which the port belongs.
IP Addr/ Netmask IP Address	This field displays the current IP address (and subnet mask) of the interface. If the IP address is 0.0.0.0 (in the IPv4 network) or :: (in the IPv6 network), the interface does not have an IP address yet.
IP Assignment	This field displays how the interface gets its IPv4 address. Static - This interface has a static IPv4 address. DHCP Client - This interface gets its IPv4 address from a DHCP server.
Action	Use this field to get or to update the IP address for the interface. Click Renew to send a new DHCP request to a DHCP server. If the interface cannot use one of these ways to get or to update its IP address, this field displays n/a .
Port Statistics Table	
Poll Interval	Enter how often you want this window to be updated automatically, and click Set Interval .
Set Interval	Click this to set the Poll Interval the screen uses.
Stop	Click this to stop the window from updating automatically. You can start it again by setting the Poll Interval and clicking Set Interval .
Switch to Graphic View	Click this to display the port statistics as a line graph.

Table 41 Monitor > Network Status (continued)

LABEL	DESCRIPTION
Name	This field displays the name of the interface.
Status	This field displays the current status of the physical port. Down - The physical port is not connected. Speed / Duplex - The physical port is connected. This field displays the port speed and duplex setting (Full or Half).
TxPkts	This field displays the number of packets transmitted from the Zyxel Device on the physical port since it was last connected.
RxPkts	This field displays the number of packets received by the Zyxel Device on the physical port since it was last connected.
Tx Bcast	This field displays the number of broadcast packets transmitted from the Zyxel Device on the physical port since it was last connected.
Rx Bcast	This field displays the number of broadcast packets received by the Zyxel Device on the physical port since it was last connected.
Collisions	This field displays the number of collisions on the physical port since it was last connected.
Tx	This field displays the transmission speed, in bytes per second, on the physical port in the one-second interval before the screen updated.
Rx	This field displays the reception speed, in bytes per second, on the physical port in the one-second interval before the screen updated.
Up Time	This field displays how long the physical port has been connected.
System Up Time	This field displays how long the Zyxel Device has been running since it last restarted or was turned on.

9.3.1 Port Statistics Graph

Use the port statistics graph to look at a line graph of packet statistics for the Ethernet port. To view, click **Monitor > Network Status** and then the **Switch to Graphic View** button.

Figure 69 Monitor > Network Status > Switch to Graphic View

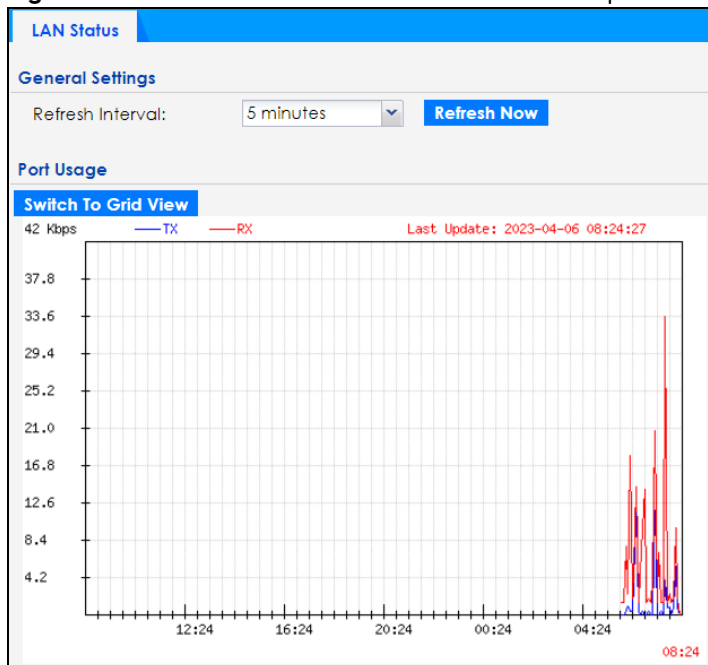

The following table describes the labels in this screen.

Table 42 Monitor > Network Status > Switch to Graphic View

LABEL	DESCRIPTION
General Settings	
Refresh Interval	Enter how often you want this window to be automatically updated.
Refresh Now	Click this to update the information in the window right away.
Port Usage	
Switch to Grid View	Click this to display the port statistics as a table.
Kbps/Mbps	The y-axis represents the speed of transmission or reception.
Time	The x-axis shows the time period over which the transmission or reception occurred.
TX	This line represents traffic transmitted from the Zyxel Device on the physical port since it was last connected.
RX	This line represents the traffic received by the Zyxel Device on the physical port since it was last connected.
Last Update	This field displays the date and time the information in the window was last updated.

9.4 Radio List

Use this screen to view statistics for the Zyxel Device's WiFi radio transmitters. To access this screen, click **Monitor > Wireless > AP Information > Radio List**.

Figure 70 Monitor > Wireless > AP Information > Radio List (for Zyxel Device that supports WDS)

St...	Freque...	Chan...	Tran...	Sta...	Upload	Downl...	MAC Addr...	R...	OP Mo...	AP / WDS Profile
💡	2.4G	1	25	0	0	670310	60:31:97:0...	1	AP (M...	default / default
💡	5G	161/1...	28	0	0	668418	60:31:97:0...	2	AP (M...	default2 / def...

Page 1 of 1 | Show 50 items | Displaying 1 - 2 of 2

Refresh

Figure 71 Monitor > Wireless > AP Information > Radio List (for Zyxel Device that does not support WDS)

Status	Frequency Band	Channel	Transmit Power	Station	Upload	Download	MAC Address	Radio	OP Mode	Chann...
💡	5G	161/157/149/153	26	0	502276	9342	00:13:49:00:00:03	2	AP (MBSSID)	25%
💡	2.4G	1	23	0	142250	0	00:13:49:00:00:02	1	AP (MBSSID)	91%

Page 1 of 1 | Show 50 items | Displaying 1 - 2 of 2

Refresh

The following table describes the labels in this screen.

Table 43 Monitor > Wireless > AP Information > Radio List

LABEL	DESCRIPTION
More Information	Click this to view additional information about the selected radio's wireless traffic and station count. Information spans a 24 hour period.
Status	This displays whether or not the radio is enabled.
Frequency Band	This indicates the wireless frequency band currently being used by the radio.
Channel	This indicates the radio's channel ID.
Transmit Power	This displays the output power of the radio.
Station	This displays the number of WiFi clients connected to this radio on the Zyxel Device.
Upload	This displays the total number of packets received by the radio.
Download	This displays the total number of packets transmitted by the radio.
MAC Address	This displays the MAC address of the radio.
Radio	This indicates the radio number on the Zyxel Device to which it belongs.
OP Mode	This indicates the radio's operating mode. Operating modes are AP (MBSSID) , Root AP or Repeater .
AP/WDS Profile	This indicates the AP profile name and WDS profile name to which the radio belongs.
Channel Utilization	This indicates how much IEEE 802.11 traffic the radio can receive on the channel. It displays what percentage of the radio's channel is currently being used.

9.4.1 AP Mode Radio Information

This screen allows you to view a selected radio's SSID details, wireless traffic statistics and station count for the preceding 24 hours. To access this window, select a radio and click the **More Information** button in the **Radio List** screen.

Figure 72 Monitor > Wireless > AP Information > Radio List > More Information

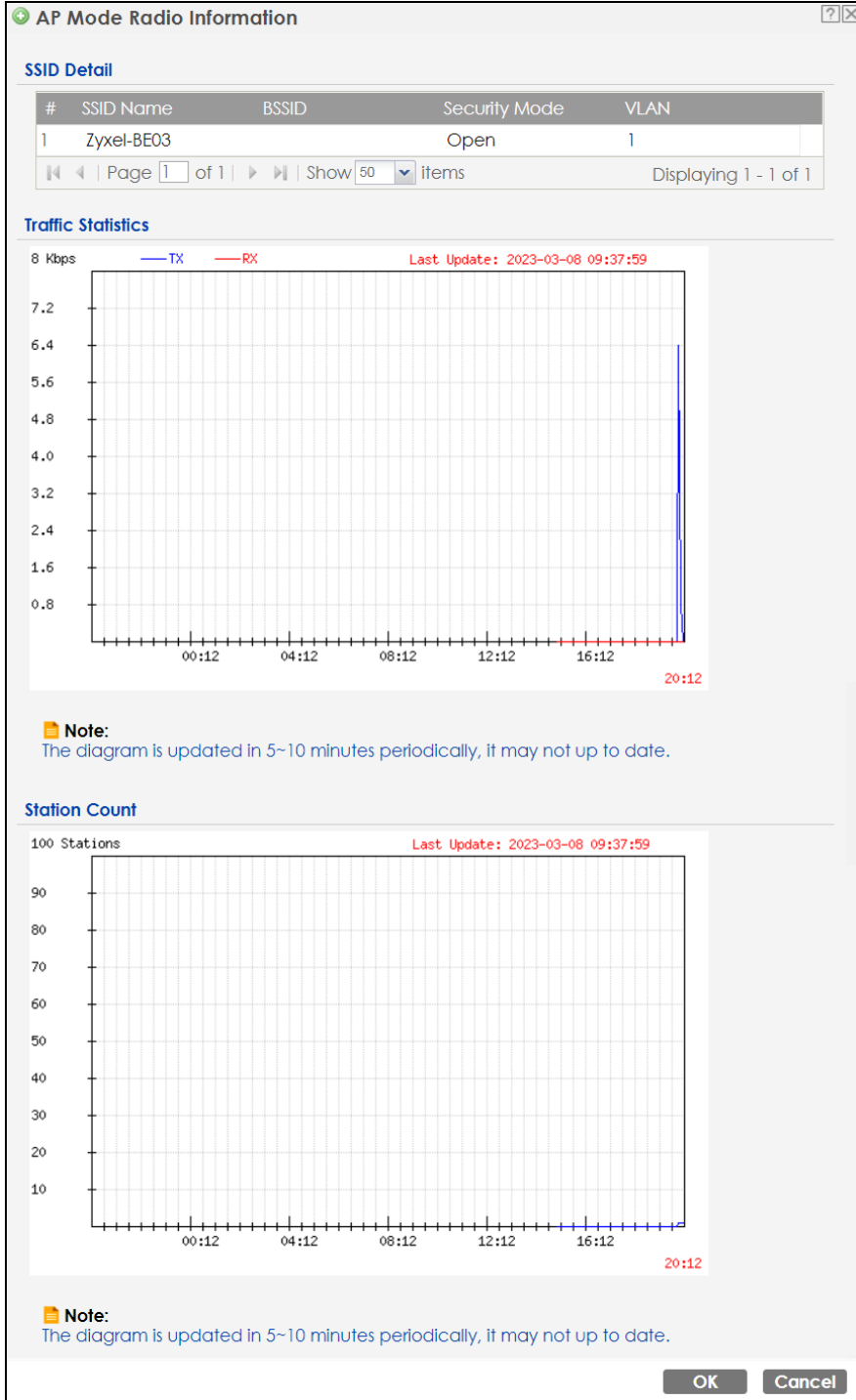

The following table describes the labels in this screen.

Table 44 Monitor > Wireless > AP Information > Radio List > More Information

LABEL	DESCRIPTION
SSID Detail	This list shows information about all the WiFi clients that have connected to the specified radio over the preceding 24 hours.
#	This is the items sequential number in the list. It has no bearing on the actual data in this list.

Table 44 Monitor > Wireless > AP Information > Radio List > More Information (continued)

LABEL	DESCRIPTION
SSID Name	This displays an SSID associated with this radio. There can be up to eight maximum.
BSSID	This displays a BSSID associated with this radio. The BSSID is tied to the SSID.
Security Mode	This displays the security mode in which the SSID is operating.
VLAN	This displays the VLAN ID associated with the SSID.
Traffic Statistics	This graph displays the overall traffic information of the radio over the preceding 24 hours.
bps/Kbps/Mbps	This y-axis represents the amount of data moved across this radio in megabytes per second.
Time	This x-axis represents the amount of time over which the data moved across this radio.
TX	This line represents traffic transmitted from the Zyxel Device on this radio.
RX	This line represents the traffic received by the Zyxel Device on this radio.
Station Count	This graph displays the connected station information of the radio over the preceding 24 hours
Stations	The y-axis represents the number of connected stations.
Time	The x-axis shows the time period over which a station was connected.
Last Update	This field displays the date and time the information in the window was last updated.
OK	Click this to save the changes.
Cancel	Click this to close this window.

9.5 Station List

Use this screen to view statistics pertaining to the associated stations (or "WiFi clients"). Click **Monitor > Wireless > Station Info > Station List** to access this screen.

Figure 73 Monitor > Wireless > Station Info > Station List

The following table describes the labels in this screen.

Table 45 Monitor > Wireless > Station Info

LABEL	DESCRIPTION
#	This is the station's index number in this list.
IP Address	This is the station's IP address.
Band	This is the frequency band to which the station is connected.
MAC Address	This is the station's MAC address.
Radio	This is the radio number on the Zyxel Device to which the station is connected.
802.11 Features	This displays whether the station supports IEEE802.11r, IEEE 802.11k, IEEE 802.11v or none of the above (N/A).
Capability	This displays the supported standard currently being used by the station or the standards supported by the station.

Table 45 Monitor > Wireless > Station Info (continued)

LABEL	DESCRIPTION
SSID Name	This indicates the name of the WiFi network to which the station is connected. A single AP can have multiple SSIDs or networks.
Security Mode	This indicates which secure encryption methods is being used by the station to connect to the network.
Signal Strength	This is the RSSI (Received Signal Strength Indicator) of the station's WiFi connection.
Rx Rate	This is the maximum reception rate of the station.
Tx Rate	This is the maximum transmission rate of the station.
Association Time	This displays the time the station first associated with the Zyxel Device's WiFi network.
Refresh	Click this to refresh the items displayed on this page.

9.6 WDS Link Info

Use this screen to view the WDS traffic statistics between the Zyxel Device and a root AP or repeaters. See [Zyxel Device Roles](#) to know more about WDS. Click **Monitor > Wireless > WDS Link Info** to access this screen.

Figure 74 Monitor > Wireless > WDS Link Info

The screenshot shows the 'WDS Link Info' interface. It has a blue header with the title 'WDS Link Info'. Below the header, there are two sections: 'WDS Uplink Info' and 'WDS Downlink Info'. Each section contains a table with columns: #, MAC Address, Band, Radio, SSID Name, Security Mode, Signal Strength, Rx Rate, and Association time. Both tables show 'Page 1 of 1' and 'Show 50 items', with a 'No data to display' message. A 'Refresh' button is located at the bottom center of the screen.

The following table describes the labels in this screen.

Table 46 Monitor > Wireless > WDS Link Info

LABEL	DESCRIPTION
WDS Uplink/ Downlink Info	<p>Uplink refers to the WDS link from the repeaters to the root AP.</p> <p>Downlink refers to the WDS link from the root AP to the repeaters.</p> <p>When the Zyxel Device is in root AP mode and connected to a repeater, only the downlink information is displayed.</p> <p>When the Zyxel Device is in repeater mode and connected to a root AP directly or through another repeater, the uplink information is displayed.</p> <p>When the Zyxel Device is in repeater mode and connected to a root AP and other repeater(s), both the uplink and downlink information would be displayed.</p>
#	This is the index number of the root AP or repeater in this list.
MAC Address	This is the MAC address of the root AP or repeater to which the Zyxel Device is connected using WDS.

Table 46 Monitor > Wireless > WDS Link Info (continued)

LABEL	DESCRIPTION
Band	This is the frequency band of the WiFi network to which the Zyxel Device is connected using WDS.
Radio	This is the radio number on the root AP or repeater to which the Zyxel Device is connected using WDS.
SSID Name	This indicates the name of the WiFi network to which the Zyxel Device is connected using WDS.
Security Mode	This indicates which secure encryption methods is being used by the Zyxel Device to connect to the root AP or repeater using WDS.
Signal Strength	This is the RSSI (Received Signal Strength Indicator) of the wireless connection in WDS.
Tx Rate	This is the maximum transmission rate of the root AP or repeater to which the Zyxel Device is connected using WDS.
Rx Rate	This is the maximum reception rate of the root AP or repeater to which the Zyxel Device is connected using WDS.
Association Time	This displays the time the Zyxel Device first associated with the wireless network using WDS.
Refresh	Click this to refresh the items displayed on this page.

9.7 Detected Device

Use this screen to view information about surrounding APs which you could mark as **Rogue** or **Friendly**. Click **Monitor > Wireless > Detected Device** to access this screen. For more information about Rogue APs, see [Rogue AP](#).

Figure 75 Monitor > Wireless > Detected Device

Detected Device										
Discovered APs										
Rogue AP:	0									
Suspected rogue AP:	140									
Friendly AP:	0									
Un-classified AP:	217									
Detect Now										
Detected Device										
<input type="checkbox"/> Mark as Rogue AP <input checked="" type="checkbox"/> Mark as Friendly AP										
#	Role	Classified by	MAC Address	SSID Name	Band	Channel ID	80...	Se...	De...	Last Seen
1	Suspected rogue AP	Weak Security	58:8B:F3:91:4B:77	Employees	5GHz	161	IE...	N...		Mon Dec 5...
2	Suspected rogue AP	Hidden SSID	BA:39:56:8C:6A:C7		2.4GHz	1	IE...	W...		Mon Dec 5...
3			A2:69:CB:7D:85:6A	Unizyx	5GHz	153	IE...	W...		Mon Dec 5...
4			B8:EC:A3:15:5A:5A	Unizyx_WLAN	2.4GHz	6	IE...	W...		Mon Dec 5...
Refresh										

The following table describes the labels in this screen.

Table 47 Monitor > Wireless > Detected Device

LABEL	DESCRIPTION
Discovered APs	
Rogue AP	This shows how many devices are detected as rogue APs.

Table 47 Monitor > Wireless > Detected Device (continued)

LABEL	DESCRIPTION
Suspected rogue AP	This shows how many devices are detected as possible rogue APs based on the classification rule(s) in Rogue AP .
Friendly AP	This shows how many devices are detected as friendly APs.
Un-classified AP	This shows how many devices are detected, but have not been classified as either Rogue or Friendly by the Zyxel Device.
Detect Now	Click this button for the Zyxel Device to scan for APs in the network.
Detected Device	
Mark as Rogue AP	Click this button to mark the selected AP as a rogue AP. For more on managing rogue APs, see the Configuration > Wireless > Rogue AP screen (Rogue AP).
Mark as Friendly AP	Click this button to mark the selected AP as a friendly AP. For more on managing friendly APs, see the Configuration > Wireless > Rogue AP screen (Rogue AP).
#	This is the detected device's index number in this list.
Role	This indicates the detected device's role (such as friendly or rogue).
Classified by	This indicates the detected device's classification rule.
MAC Address	This indicates the detected device's MAC address.
SSID Name	This indicates the detected device's SSID.
Band	This is the frequency band to which the station is connected.
Channel ID	This indicates the detected device's channel ID.
802.11 Mode	This indicates the 802.11 mode (a/b/g/n/ac/ax) transmitted by the detected device.
Security	This indicates the encryption method (if any) used by the detected device.
Description	This displays the detected device's description. For more on managing friendly and rogue APs, see the Configuration > Wireless > Rogue AP screen (Rogue AP).
Last Seen	This indicates the last time the device was detected by the Zyxel Device.
Refresh	Click this to refresh the items displayed on this page.

9.8 View Log

Log messages are stored in two separate logs, one for regular log messages and one for debugging messages. In the regular log, you can look at all the log messages by selecting **All Logs**, or you can select a specific category of log messages (for example, user). You can also look at the debugging log by selecting **Debug Log**. All debugging messages have the same priority.

To access this screen, click **Monitor > Log**. The log is displayed in the following screen.

Note: When a log reaches the maximum number of log messages, new log messages automatically overwrite existing log messages, starting with the oldest existing log message first.

Events that generate an alert (as well as a log message) display in red. Regular logs display in black. Click a column's heading cell to sort the table entries by that column's criteria. Click the heading cell again to reverse the sort order.

The Web Configurator saves the filter settings once you click **Search**. If you leave the **View Log** screen and return to it later, the last filter settings would still apply.

Figure 76 Monitor > Log > View Log

View Log

Hide Filter

Logs

Display: All Logs Priority: any

Source Address: Destination Address:

Source Interface: any Destination Interface: any

Protocol: any Keyword:

Search

Refresh | Clear Log

#	Time	Priority	Category	Message	Source	Dest...	Note
77	2022-12-05 ...	info	User	Admin's password has been changed.			USER
6	2022-12-05 ...	notice	User	Administrator admin http/https login.			Account: admin
75	2022-12-05 ...	notice	User	Administrator admin http/https login.			Account: admin
78	2022-12-05 ...	notice	User	Administrator admin http/https login.			Account: admin
76	2022-12-05 ...	notice	User	Administrator admin http/https logout			Account: admin
35	2022-12-05 ...	notice	User	Administrator admin http/https logout (lease timeout).			Account: admin
79	2022-12-05 ...	alert	User	Failed login attempt to WAX640S-6E from			Account: admin
1...	2022-12-04 ...	error	System	NTP update failed with Missing default gateway setting.			System

Page 1 of 11 | Show 50 items | Displaying 1 - 50 of 512

The following table describes the labels in this screen.

Table 48 Monitor > Log > View Log

LABEL	DESCRIPTION
Show Filter or Hide Filter	Click this button to show or hide the filter settings. The Priority , Source Address , Destination Address , Source Interface , Destination Interface , Protocol , Keyword , and Search fields are only available if the filter settings are shown.
Display	Select the category of log message(s) you want to view. You can also view All Logs at one time, or you can view the Debug Log .
Priority	This displays when you show the filter. Select the priority of log messages to display. The log displays the log messages with this priority or higher. Choices are: any , emerg , alert , crit , error , warn , notice , and info , from highest priority to lowest priority. This field is read-only if the Category is Debug Log .
Source Address	This displays when you show the filter. Type the source IP address of the incoming packet that generated the log message. Do not include the port in this filter.
Destination Address	This displays when you show the filter. Type the IP address of the destination of the incoming packet when the log message was generated. Do not include the port in this filter.
Source Interface	This displays when you show the filter. Select the source interface of the packet that generated the log message.
Destination Interface	This displays when you show the filter. Select the destination interface of the packet that generated the log message.
Protocol	This displays when you show the filter. Select a service protocol whose log messages you would like to see.
Keyword	This displays when you show the filter. Type a keyword to look for in the Message , Source , Destination and Note fields. If a match is found in any field, the log message is displayed. You can use up to 63 alphanumeric characters and the underscore, as well as punctuation marks () ' , ; ; ? ! + - * / = # \$ % @ ; the period, double quotes, and brackets are not allowed.
Search	This displays when you show the filter. Click this button to update the log using the current filter settings.
Refresh	Click this to update the list of logs.

Table 48 Monitor > Log > View Log (continued)

LABEL	DESCRIPTION
Clear Log	Click this button to clear the whole log, regardless of what is currently displayed on the screen.
#	This field is a sequential value, and it is not associated with a specific log message.
Time	This field displays the time the log message was recorded.
Priority	This field displays the priority of the log message. It has the same range of values as the Priority field above.
Category	This field displays the log that generated the log message. It is the same value used in the Display and (other) Category fields.
Message	This field displays the reason the log message was generated. The text "[count=x]", where x is a number, appears at the end of the Message field if log consolidation is turned on and multiple entries were aggregated to generate into this one.
Source	This field displays the source IP address and the port number in the event that generated the log message.
Source Interface	This field displays the source interface of the packet that generated the log message.
Destination	This field displays the destination IP address and the port number of the event that generated the log message.
Destination Interface	This field displays the destination interface of the packet that generated the log message.
Protocol	This field displays the service protocol in the event that generated the log message.
Note	This field displays any additional information about the log message.

CHAPTER 10

Network

10.1 Overview

This chapter describes how you can configure the management IP address and VLAN settings of your Zyxel Device.

The Internet Protocol (IP) address identifies a device on a network. Every networking device (including computers, servers, routers, printers, etc.) needs an IP address to communicate across the network. These networking devices are also known as hosts.

Figure 77 IP Setup

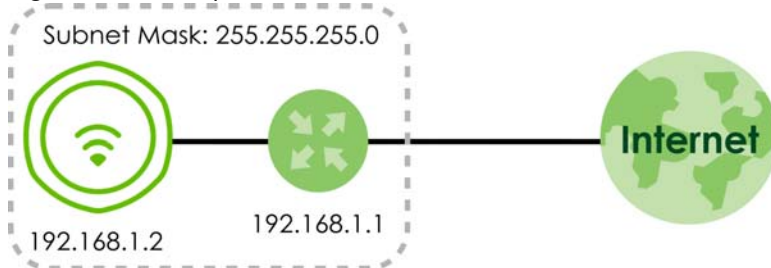

The figure above illustrates one possible setup of your Zyxel Device. The gateway IP address is 192.168.1.1 and the managed IP address of the Zyxel Device is 192.168.1.2 (default), but if the Zyxel Device is assigned an IP address by a DHCP server, the default (192.168.1.2) will not be used. The gateway and the Zyxel Device must belong in the same IP subnet to be able to communicate with each other.

10.1.1 What You Can Do in this Chapter

- The **IP Setting** screen ([IP Setting](#)) configures the Zyxel Device's LAN IP address.
- The **VLAN** screen ([VLAN](#)) configures the Zyxel Device's VLAN settings.

10.2 IP Setting

Use this screen to configure the IP address for your Zyxel Device. To access this screen, click **Configuration > Network > IP Setting**.

Figure 78 Configuration > Network > IP Setting (DHCP)

IP Setting		VLAN	
IP Address Assignment			
IP type:	Static IP		
IP Address:	<input type="text"/>		
Subnet Mask:	<input type="text"/>		
Gateway:	<input type="text"/>	(Optional)	
DNS Server IP Address:	<input type="text"/>	(Optional)	
IPv6 Address Assignment			
<input type="checkbox"/> Enable Stateless Address Auto-configuration(SLAAC)			
Link-Local Address:			
IPv6 Address/Prefix Length:	<input type="text"/>	(Optional)	
Gateway:	<input type="text"/>	(Optional)	
Metric:	<input type="text"/>	(0-15)	
<input type="checkbox"/> DHCPv6 Client			
DUID:			
<input type="checkbox"/> Request Address			
DHCPv6 Request Options			
<input type="checkbox"/> DNS Server			
<input type="checkbox"/> NTP Server			
		Apply	Reset

Figure 79 Configuration > Network > IP Setting (Static IP)

IP Setting		VLAN	
IP Address Assignment			
IP type:	DHCP		
<input checked="" type="checkbox"/> Use Fixed DNS Server IP Address			
DNS Server IP Address:	<input type="text"/>	!	
IPv6 Address Assignment			
<input checked="" type="checkbox"/> Enable Stateless Address Auto-configuration(SLAAC)			
Link-Local Address:			
IPv6 Address/Prefix Length:	<input type="text"/>	(Optional)	
Gateway:	<input type="text"/>	(Optional)	
Metric:	<input type="text"/>	(0-15)	
<input checked="" type="checkbox"/> DHCPv6 Client			
DUID:			
<input type="checkbox"/> Request Address			
DHCPv6 Request Options			
<input type="checkbox"/> DNS Server			
<input type="checkbox"/> NTP Server			
		Apply	Reset

Each field is described in the following table.

Table 49 Configuration > Network > IP Setting

LABEL	DESCRIPTION
IP Address Assignment	
IP Type	Select DHCP to make the interface a DHCP client and automatically get the IP address, subnet mask, gateway and DNS Server IP address from a DHCP server. Select Static IP to specify the IP address, subnet mask, gateway and DNS server IP address manually.
Use Fixed DNS Server IP Address	Select this if you have a preferred DNS server that you want to specify manually even if the IP type is DHCP. Setting a fixed DNS server IP address may help if you experience unreliable DNS resolution.
IP Address	Enter the IP address for this interface.
Subnet Mask	Enter the subnet mask of this interface in dot decimal notation. The subnet mask indicates what part of the IP address is the same for all computers in the network.
Gateway	Enter the IP address of the gateway. The Zyxel Device sends packets to the gateway when it does not know how to route the packet to its destination. The gateway should be on the same network as the interface.
DNS Server IP Address	Enter the IP address of the DNS server.
IPv6 Address Assignment	
Enable Stateless Address Auto-configuration (SLAAC)	Select this to enable IPv6 stateless auto-configuration on the Zyxel Device. The Zyxel Device will generate an IPv6 address itself from a prefix obtained from an IPv6 router in the network.
Link-Local Address	This displays the IPv6 link-local address and the network prefix that the Zyxel Device generates itself for the LAN interface.
IPv6 Address/Prefix Length	Enter the IPv6 address and the prefix length for the LAN interface if you want to use a static IP address. This field is optional. The prefix length indicates what the left-most part of the IP address is the same for all computers in the network, that is, the network address.
Gateway	Enter the IPv6 address of the default outgoing gateway using colon (:) hexadecimal notation.
Metric	Enter the priority of the gateway (if any) on the LAN interface. The Zyxel Device decides which gateway to use based on this priority. The lower the number, the higher the priority. If two or more gateways have the same priority, the Zyxel Device uses the one that was configured first. Enter zero to set the metric to 1024 for IPv6.
DHCPv6 Client	Select this option to set the Zyxel Device to act as a DHCPv6 client.
DUID	This field displays the DHCP Unique Identifier (DUID) of the Zyxel Device, which is unique and used for identification purposes when the Zyxel Device is exchanging DHCPv6 messages with others. See IPv6 for more information.
Request Address	Select this option to get an IPv6 address from the DHCPv6 server.
DHCPv6 Request Options	Select the following DHCPv6 options to determine what additional information to get from the DHCPv6 server.
DNS Server	Select this option to obtain the IP address of the DNS server.
NTP Server	Select this option to obtain the IP address of the NTP server.
Apply	Click Apply to save your changes back to the Zyxel Device.
Reset	Click Reset to return the screen to its last-saved settings.

10.3 VLAN

This section discusses how to configure the Zyxel Device's VLAN settings.

Note: Mis-configuring the management VLAN settings on your Zyxel Device can make it inaccessible. If this happens, you will have to reset the Zyxel Device.

Figure 80 Management VLAN Setup

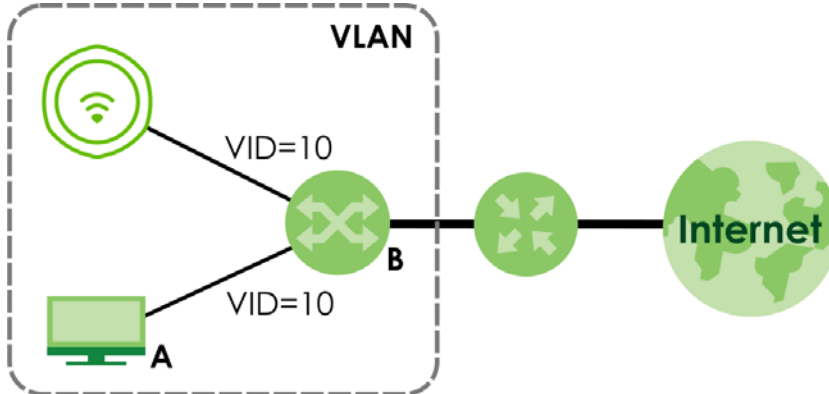

In the figure above, to access and manage the Zyxel Device from computer **A**, the Zyxel Device and switch **B**'s ports to which computer **A** and the Zyxel Device are connected should be in the same VLAN.

A Virtual Local Area Network (VLAN) allows a physical network to be partitioned into multiple logical networks. Devices on a logical network belong to one group. A device can belong to more than one group. With VLAN, a device cannot directly talk to or hear from devices that are not in the same group(s); the traffic must first go through a router.

VLAN also increases network performance by limiting broadcasts to a smaller and more manageable logical broadcast domain. In traditional switched environments, all broadcast packets go to each and every individual port. With VLAN, all broadcasts are confined to a specific broadcast domain.

Wireless Bridge VLAN ID

Wireless bridge VLAN allows you to have clients in different WiFi networks appear to be in the same virtual network using VLAN IDs. VLAN IDs are sent across the wireless bridge so that only clients with the same VLAN ID receive that network traffic. See [Zyxel Device Roles](#) for more information on the wireless bridge.

In the figure below, a client (**C2**) in the branch office (**B**) wants to connect to the main office (**M**). The branch office client (**C2**) can connect to the main office network using the **VLAN ID 10**. However, the branch office client (**C2**) cannot connect to the to the main office network using the **VLAN ID 20** because that VLAN ID does not exist in the main office network. To bridge the branch office network and the main office network, the VLAN IDs you set on the Zyxel Device (**X**) should be the same as the VLAN IDs you set on the root AP (**Y**).

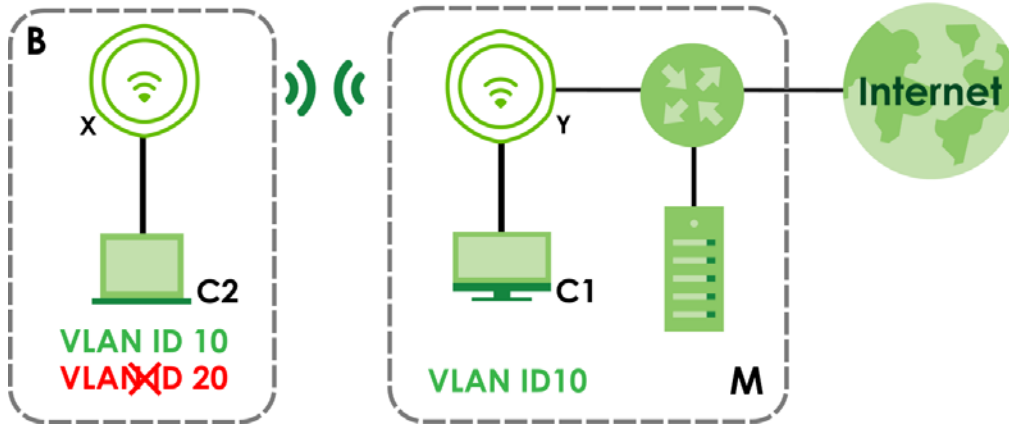
Figure 81 Wireless Bridge VLAN ID Example

IEEE 802.1Q Tag

The IEEE 802.1Q standard defines an explicit VLAN tag in the MAC header to identify the VLAN membership of a frame across bridges. A VLAN tag includes the 12-bit VLAN ID and 3-bit user priority. The VLAN ID associates a frame with a specific VLAN and provides the information that devices need to process the frame across the network.

Use this screen to configure the VLAN settings for your Zyxel Device. To access this screen, click **Configuration > Network > VLAN**.

Note: Not all Zyxel Devices support the wireless bridge VLAN settings; see [Zyxel Device Product Feature Comparison](#) for more information.

Figure 82 Configuration > Network > VLAN

The screenshot shows the 'VLAN' configuration page. The 'Management VLAN ID' is set to 1, with a range of 1-4094. The 'As Native VLAN' checkbox is checked. There are 'Apply' and 'Reset' buttons at the bottom.

Figure 83 Configuration > Network > VLAN (for models that support Wireless Bridge)

Each field is described in the following table.

Table 50 Configuration > Network > VLAN

LABEL	DESCRIPTION
VLAN Settings	
Management VLAN ID	Enter a VLAN ID for the Zyxel Device. The range is 1–4094.
As Native VLAN	Select this option to treat the Management VLAN ID as a VLAN created on the Zyxel Device and not one assigned to it from outside the network. Outbound traffic transmitted through the Zyxel Device Ethernet port will NOT be tagged with the Management VLAN ID . Clear this option to have the Zyxel Device add the Management VLAN ID tag to outbound traffic transmitted through the Zyxel Device Ethernet port. The uplink device connected to the Zyxel Device Ethernet port needs to have the same VLAN ID configured to receive traffic from the Zyxel Device.
Wireless Bridge Vlan Setting	This section appears if your Zyxel Device supports wireless bridge. See the feature comparison table in Zyxel Device Product Feature Comparison .
Add	Click this to add an entry in the table.
Remove	Select an entry and click this to remove the selected entry.
#	This field is a sequential value. It is not associated with any VLAN ID.
Wireless Bridge Vlan ID (1-4094)	Enter a VLAN ID for the wireless bridge. Duplicate VLAN IDs are not allowed. The VLAN IDs you set on your root AP should be the same as the VLAN IDs you set here. See Zyxel Device Roles for more information on wireless bridge.
Apply	Click Apply to save your changes back to the Zyxel Device.
Reset	Click Reset to return the screen to its last-saved settings.

CHAPTER 11

Wireless

11.1 Overview

This chapter discusses how to configure the WiFi network settings in your Zyxel Device.

The following figure provides an example of a WiFi network.

Figure 84 Example of a WiFi Network

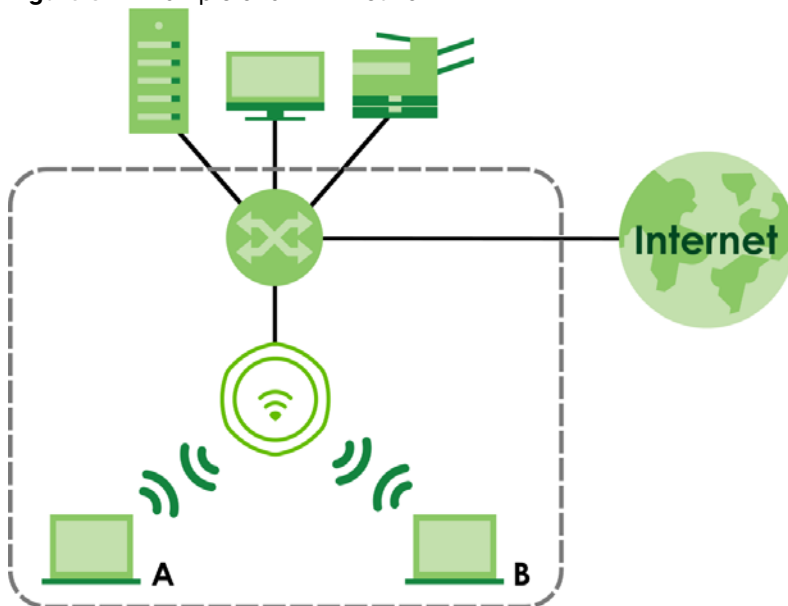

The WiFi network is the area within the dotted line. In this WiFi network, devices **A** and **B** are called WiFi clients. The WiFi clients use the Zyxel Device to interact with other devices (such as the printer) or with the Internet.

11.1.1 What You Can Do in this Chapter

- The **AP Management** screen ([AP Management](#)) allows you to manage the Zyxel Device's general WiFi settings.
- The **Rogue AP** screen ([Rogue AP](#)) allows you to assign APs either to the rogue AP list or the friendly AP list.
- The **DCS** screen ([DCS](#)) allows you to configure dynamic radio channel selection.

11.1.2 What You Need to Know

The following terms and concepts may help as you read this chapter.

Station / WiFi Client

A station or WiFi client is any WiFi-capable device that can connect to an AP using a WiFi signal.

Dynamic Channel Selection (DCS)

Dynamic Channel Selection (DCS) is a feature that allows an AP to automatically select the radio channel which it broadcasts. For more information, see [Section Figure 94 on page 168](#).

11.2 AP Management

Use this screen to manage the Zyxel Device's general WiFi settings. Click **Configuration > Wireless > AP Management** to access this screen.

Note: Not all Zyxel Devices support the wireless bridge VLAN settings; see [Zyxel Device Product Feature Comparison](#) for more information.

Figure 85 Configuration > Wireless > AP Management– AP Mode (for 2.4 GHz and 5 GHz models)

WLAN Setting
Create new Object ▾

Radio 1 Setting

Radio 1 Activate

Radio 1 OP Mode: AP Mode Root AP Repeater ⓘ

Radio 1 Profile: + ✎ ⓘ

Max Output Power: dBm (0~30)

MBSSID Settings

#	SSID Profile	Band
1	Wiz_SSID_1	2.4G/5G ✎
2	disable	
3	disable	
4	disable	
5	disable	
6	disable	
7	disable	
8	disable	

Radio 2 Setting

Radio 2 Activate

Radio 2 OP Mode: AP Mode Root AP Repeater ⓘ

Radio 2 Profile: + ✎ ⓘ

Max Output Power: dBm (0~30)

MBSSID Settings

#	SSID Profile	Band
1	Wiz_SSID_1	2.4G/5G ✎
2	disable	
3	disable	
4	disable	
5	disable	
6	disable	
7	disable	
8	disable	

Apply **Reset**

Figure 86 Configuration > Wireless > AP Management (for 2.4 GHz, 5 GHz, and 6 GHz models)

WLAN Setting
 Create new Object ▾

Radio 1 Setting

Radio 1 Activate

Radio 1 OP Mode: AP Mode Root AP Repeater ⓘ

Radio 1 Profile: default ▾ + ✎ ⓘ

Max Output Power: 30 dBm (0~30)

MBSSID Settings

#	SSID Profile	Band
1	default	2.4G/5G/6G ✎
2	disable	
3	disable	
4	disable	
5	disable	
6	disable	
7	disable	
8	disable	

Radio 2 Setting

Radio 2 Activate

Radio 2 OP Mode: AP Mode Root AP Repeater ⓘ

Radio 2 Profile: default2 ▾ + ✎ ⓘ

Max Output Power: 30 dBm (0~30)

MBSSID Settings

#	SSID Profile	Band
1	default	2.4G/5G/6G ✎
2	disable	
3	disable	
4	disable	
5	disable	
6	disable	
7	disable	
8	disable	

Figure 87 Configuration > Wireless > AP Management– Repeater Mode (for 2.4 GHz and 5 GHz models)

WLAN Setting

Create new Object

Radio 1 Setting

Radio 1 Activate

Radio 1 OP Mode: AP Mode Root AP Repeater i

Radio 1 Profile: + ✎ i

Radio 1 WDS Profile: + ✎

Uplink Selection Mode: AUTO Manual

Max Output Power: dBm (0~30)

MBSSID Settings

#	SSID Profile	Band	
1	Wiz_SSID_1	2.4G/5G	<input checked="" type="checkbox"/>
2	disable		
3	disable		
4	disable		
5	disable		
6	disable		
7	disable		
8	disable		

Radio 2 Setting

Radio 2 Activate

Radio 2 OP Mode: AP Mode Root AP Repeater i

Radio 2 Profile: + ✎ i

Max Output Power: dBm (0~30)

MBSSID Settings

#	SSID Profile	Band	
1	Wiz_SSID_1	2.4G/5G	<input checked="" type="checkbox"/>
2	disable		
3	disable		
4	disable		
5	disable		
6	disable		
7	disable		
8	disable		

Apply **Reset**

Figure 88 Configuration > Wireless > AP Management– Repeater Mode (for 2.4 GHz, 5 GHz and 6 GHz models)

WLAN Setting

Create new Object ▾

Radio 1 Setting

Radio 1 Activate

Radio 1 OP Mode: AP Mode Root AP Repeater ⓘ

Radio 1 Profile: + ⓘ ⓘ ⓘ

Radio 1 WDS Profile: + ⓘ ⓘ ⓘ

Enable WDS Wireless Bridging

Uplink Selection Mode: AUTO Manual

Max Output Power: dBm (0~30)

MBSSID Settings

#	SSID Profile	Band		
1	default	2.4G/5G/6G	+	ⓘ
2	disable		+	
3	disable		+	
4	disable		+	
5	disable		+	
6	disable		+	
7	disable		+	
8	disable		+	

Radio 2 Setting

Radio 2 Activate

Radio 2 OP Mode: AP Mode Root AP Repeater ⓘ

Radio 2 Profile: + ⓘ ⓘ ⓘ

Max Output Power: dBm (0~30)

MBSSID Settings

#	SSID Profile	Band		
1	default	2.4G/5G/6G	+	ⓘ
2	disable		+	
3	disable		+	
4	disable		+	
5	disable		+	
6	disable		+	
7	disable		+	
8	disable		+	

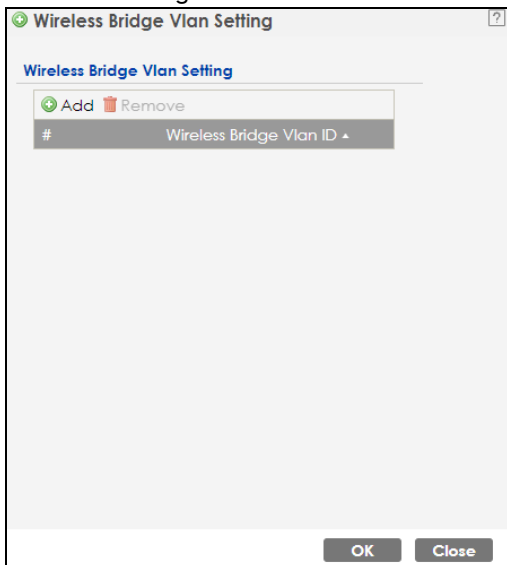
Figure 89 Configuration > Wireless > AP Management > Setup Wireless Bridge Vlan ID: Wireless Bridge Vlan Setting

Each field is described in the following table.

Table 51 Configuration > Wireless > AP Management



LABEL	DESCRIPTION
Radio 1 Setting	
Radio 1 Activate	Select the checkbox to enable the Zyxel Device's first (default) radio.
Radio 1 OP Mode	Select the operating mode for radio 1. AP Mode means the radio can receive connections from WiFi clients and pass their data traffic through to the Zyxel Device to be managed (or subsequently passed on to an upstream gateway for managing). Root AP means the radio acts as an AP and also supports the wireless connections with other APs (in repeater mode) to form a WDS (Wireless Distribution System) to extend its wireless network. Repeater means the radio can establish a wireless connection with other APs (in either root AP or repeater mode) to form a WDS.
Radio 1 Profile	Select the radio profile the radio uses. Note: You can only apply a 2.4G AP radio profile to radio 1. Otherwise, the first radio will not be working.
Add 	This button is not available after you configure the Zyxel Device using the wizard. Click the Add icon () to open a screen where you can create a new entry. For features where the entry's position in the numbered list is important (features where the Zyxel Device applies the table's entries in order like the SSID for example), you can select an entry and click Add to create a new entry after the selected entry.
Radio 1 WDS Profile	This field is available only when the radio is in Root AP or Repeater mode. Select the WDS profile the radio uses to connect to a root AP or repeater.

Table 51 Configuration > Wireless > AP Management (continued)







LABEL	DESCRIPTION
Enable WDS Wireless Bridging	<p>If you set the Zyxel Device as a root AP, the radio that's bridging with the Zyxel Device should be in repeater mode.</p> <p>Be careful to avoid bridge loops. For example, if your root AP and the Zyxel Device are connected to a switch, and they're also connected to each other using a WiFi connection. This will create bridge loops.</p> <p>This field is available only when the radio is in Repeater mode. Select this to enable WDS wireless bridging on the Zyxel Device. See Zyxel Device Roles for more information on Wireless Distribution System (WDS).</p>
Uplink Selection Mode	<p>This field is available only when the radio is in Repeater mode.</p> <p>Select AUTO to have the Zyxel Device automatically use the settings in the applied WDS profile to connect to a root AP or repeater.</p> <p>Select Manual to have the Zyxel Device connect to the root AP or repeater with the MAC address specified in the Radio 1 Uplink MAC Address field.</p>
Setup Wireless Bridge Vlan ID	<p>This appears if you select Enable WDS Wireless Bridging.</p> <p>Click this to show the Wireless Bridge Vlan Setting pop-up window. This link is available only when the radio is in Root AP or Repeater mode.</p>
Wireless Bridge Vlan Setting	
Add	Click this to add an entry in the table.
Remove	Select an entry and click this to remove the selected entry.
#	This field is a sequential value. It is not associated with any VLAN ID.
Wireless Bridge Vlan ID	Enter a VLAN ID for the wireless bridge. The VLAN IDs you set on your root AP should be the same as the VLAN ID you set here. See Zyxel Device Roles for more information on wireless bridge.
OK	Click OK to save your changes back to the Zyxel Device.
Close	Click Close to close the pop-up window without saving your changes.
Max Output Power	<p>Enter the maximum output power (between 0 to 30 dBm) of the Zyxel Device in this field. If there is a high density of APs in an area, decrease the output power of the Zyxel Device to reduce interference with other APs.</p> <p>Note: Reducing the output power also reduces the Zyxel Device's effective broadcast radius.</p>
MBSSID Settings	
Edit 	Click the Edit icon () to open a screen where you can modify the entry's settings. In some tables you can just click a table entry and edit it directly in the table. For those types of tables small red triangles display for table entries with changes that you have not yet applied.
#	This field shows the index number of the SSID
SSID Profile	This field displays the SSID profile that is associated with the radio profile.
Band	<p>This field displays the frequency bands to which the SSID profile is applicable. If the SSID profile is not applicable to the current radio, the SSID profile will not be enabled.</p> <p>You can configure the SSID profile's applicable frequency bands in the Edit SSID Profile screen (click the Edit button next to the profile).</p>
Add 	<p>This button is not available after you configure the Zyxel Device using the wizard.</p> <p>Click the Add icon () to open a screen where you can create a new entry. For features where the entry's position in the numbered list is important (features where the Zyxel Device applies the table's entries in order like the SSID for example), you can select an entry and click Add to create a new entry after the selected entry.</p>

Table 51 Configuration > Wireless > AP Management (continued)

LABEL	DESCRIPTION
Radio 2 Setting	
Radio 2 Activate	<p>This displays if the Zyxel Device has a second radio.</p> <p>Select the checkbox to enable the Zyxel Device's second radio.</p>
Radio 2 OP Mode	<p>This displays if the Zyxel Device has a second radio. Select the operating mode for radio 2.</p> <p>AP Mode means the radio can receive connections from WiFi clients and pass their data traffic through to the Zyxel Device to be managed (or subsequently passed on to an upstream gateway for managing).</p> <p>Root AP means the radio acts as an AP and also supports the wireless connections with other APs (in repeater mode) to form a WDS to extend its wireless network.</p> <p>Repeater means the radio can establish a wireless connection with other APs (in either root AP or repeater mode) to form a WDS.</p>
Radio 2 Profile	This displays if the Zyxel Device has a second radio. Select the radio profile the radio uses.
Radio 2 WDS Profile	<p>This field is available only when the radio is in Root AP or Repeater mode.</p> <p>Select the WDS profile the radio uses to connect to a root AP or repeater.</p>
Enable WDS Wireless Bridging	<p>If you set the Zyxel Device as a root AP, the radio that's bridging with the Zyxel Device should be in repeater mode.</p> <p>Be careful to avoid bridge loops. For example, if your root AP and the Zyxel Device are connected to a switch, and they're also connected to each other using a WiFi connection. This will create bridge loops.</p> <p>This field is available only when the radio is in Repeater mode. Select this to enable WDS wireless bridging on the Zyxel Device. See Zyxel Device Roles for more information on Wireless Distribution System (WDS).</p>
Uplink Selection Mode	<p>This field is available only when the radio is in Repeater mode.</p> <p>Select AUTO to have the Zyxel Device automatically use the settings in the applied WDS profile to connect to a root AP or repeater.</p> <p>Select Manual to have the Zyxel Device connect to the root AP or repeater with the MAC address specified in the Radio 1 Uplink MAC Address field.</p>
Setup Wireless Bridge Vlan ID	Click this to show the Wireless Bridge Vlan Setting pop-up window. This link is available only when the radio is in Root AP or Repeater mode.
Wireless Bridge Vlan Setting	
Add	Click this to add an entry in the table.
Remove	Select an entry and click this to remove the selected entry.
#	This field is a sequential value. It is not associated with any VLAN ID.
Wireless Bridge Vlan ID	Enter a VLAN ID for the wireless bridge. The VLAN IDs you set on your root AP should be the same as the VLAN ID you set here. See Zyxel Device Roles for more information on wireless bridge.
OK	Click OK to save your changes back to the Zyxel Device.
Close	Click Close to close the pop-up window without saving your changes.
Max Output Power	<p>Enter the maximum output power (between 0 to 30 dBm) of the Zyxel Device in this field. If there is a high density of APs in an area, decrease the output power of the Zyxel Device to reduce interference with other APs.</p> <p>Note: Reducing the output power also reduces the Zyxel Device's effective broadcast radius.</p>
MBSSID Settings	

Table 51 Configuration > Wireless > AP Management (continued)

LABEL	DESCRIPTION
Edit 	Click Edit () to open a screen where you can modify the entry's settings. In some tables you can just click a table entry and edit it directly in the table. For those types of tables small red triangles display for table entries with changes that you have not yet applied.
#	This field shows the index number of the SSID
SSID Profile	This field shows the SSID profile that is associated with the radio profile.
Band	This field displays the radio bands to which the SSID profile is applicable. If the SSID profile is not applicable to the current radio, the SSID profile will not be enabled. You can configure the SSID profile's applicable radio bands in the Edit SSID Profile screen (click the Edit button next to the profile).
Apply	Click Apply to save your changes back to the Zyxel Device.
Reset	Click Reset to return the screen to its last-saved settings.

11.3 Rogue AP

Use this screen to enable **Rogue AP Detection** and import/export a rogue or friendly AP list in a txt file. Click **Configuration > Wireless > Rogue AP** to access this screen.

Rogue APs

A rogue AP is a wireless access point operating in a network's coverage area that is not under the control of the network administrator, and which can potentially open up holes in a network's security.

In the following example, a corporate network's security is compromised by a rogue AP (**RG**) set up by an employee at his workstation in order to allow him to connect his notebook computer wirelessly (**A**). The company's legitimate WiFi network (the dashed ellipse **B**) is well-secured, but the rogue AP uses inferior security that is easily broken by an attacker (**X**) running readily available encryption-cracking software. In this example, the attacker now has access to the company network, including sensitive data stored on the file server (**C**).

Figure 90 Rogue AP Example

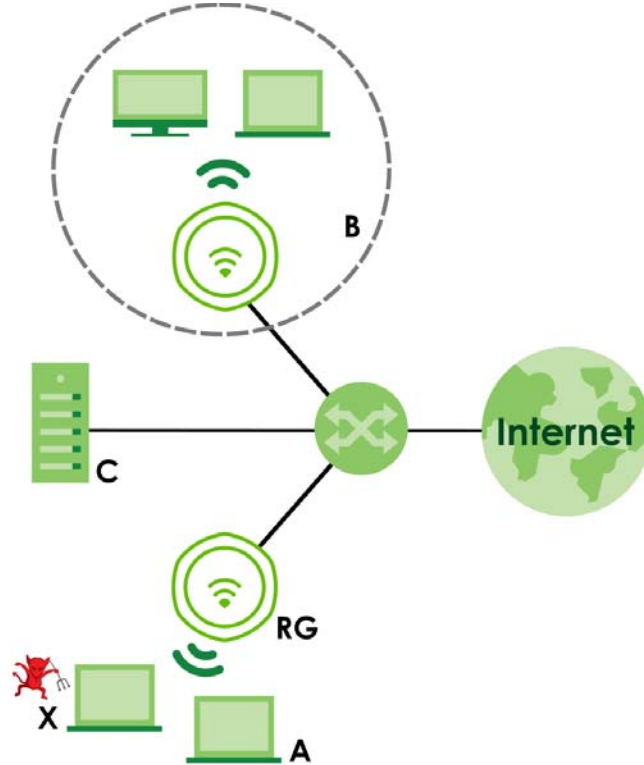

Friendly APs

If you have more than one AP in your WiFi network, you should also configure a list of “friendly” APs. Friendly APs are wireless access points that you know are not a threat. It is recommended that you export (save) your list of friendly APs often, especially if you have a network with a large number of access points. Exported lists show MAC addresses in txt file format separated by line breaks.

Rogue AP Detection

This feature allows the Zyxel Device to monitor the WiFi signals for other wireless APs (see also [Radio Frequency \(RF\) Monitor](#)). Detected APs will appear in the **Monitor > Wireless > Detected Device** screen, where the Zyxel Device will label APs with the criteria you select in **Suspected Rogue AP Classification Rule** as a suspected rogue. The APs which you mark as either rogue or friendly APs in the **Monitor > Wireless > Detected Device** screen will appear in the **Wireless > Rogue AP** screen. See [Zyxel Device Product Feature Comparison](#) to know which models support **Rogue AP Detection**.

Note: Enabling **Rogue AP Detection** might affect the performance of WiFi clients associated with the Zyxel Device.

Figure 91 Configuration > Wireless > Rogue AP

Rogue/Friendly AP List

Rogue AP Detection Setting

Enable Rogue AP Detection

Suspected Rogue AP Classification Rule

Weak Security (Open, WEP, WPA-PSK)

Hidden SSID

SSID Keyword

+ Add Edit Remove

#	SSID Keyword
1	test

Rogue/Friendly AP List

+ Add Edit Remove

#	Role	MAC Address	Description
1	friendly-ap	60:31:97:7D:5B:51	
2	rogue-ap	00:A0:C5:01:23:45	rogue-ap

Page 1 of 1 | Show 50 items | Displaying 1 - 2 of 2

Rogue AP List Importing/Exporting

File: **Browse...** **Importing** **Exporting**

Friendly AP List Importing/Exporting

File: **Browse...** **Importing** **Exporting**

Apply **Reset**

Each field is described in the following table.

Table 52 Configuration > Wireless > Rogue AP

LABEL	DESCRIPTION
Rogue AP Detection Setting	
Enable Rogue AP Detection	Select this checkbox to detect Rogue APs in the network.
Suspected Rogue AP Classification Rule	Select the checkboxes (Weak Security (Open, WEP, WPA-PSK) , Hidden SSID , SSID Keyword) of the characteristics an AP should have for the Zyxel Device to mark it as a Rogue AP.
Add	Click this to add an SSID Keyword.
Edit	Select an SSID Keyword and click this button to modify it.
Remove	Select an existing SSID keyword and click this button to delete it.
#	This is the SSID Keyword's index number in this list.
SSID Keyword	This field displays the SSID Keyword.
Rogue/Friendly AP List	
Add	Click this button to add an AP to the list and assign it either friendly or rogue status.
Edit	Select an AP in the list to edit and reassign its status.

Table 52 Configuration > Wireless > Rogue AP (continued)

LABEL	DESCRIPTION
Remove	Select an AP in the list to remove.
#	This field is a sequential value, and it is not associated with any interface.
Role	This field indicates whether the selected AP is a rogue-ap or a friendly-ap . To change the AP's role, click the Edit button.
MAC Address	This field indicates the AP's radio MAC address.
Description	This field displays the AP's description. You can modify this by clicking the Edit button.
Rogue/Friendly AP List Importing/Exporting	These controls allow you to export the current list of rogue and friendly APs or import existing lists.
File Path / Browse / Importing	Enter the file name and path of the list you want to import or click the Browse button to locate it. Once the File Path field has been populated, click Importing to bring the list into the Zyxel Device. You need to wait a while for the importing process to finish.
Exporting	Click this button to export the current list of either rogue APs or friendly APS.
Apply	Click Apply to save your changes back to the Zyxel Device.
Reset	Click Reset to return the screen to its last-saved settings.

11.3.1 Add/Edit Rogue/Friendly AP List

Click **Add** or select an AP and click the **Edit** button in the **Configuration > Wireless > Rogue AP** table to display this screen.

Figure 92 Configuration > Wireless > Rogue AP > Add/Edit Rogue/Friendly AP List

Each field is described in the following table.

Table 53 Configuration > Wireless > Rogue AP > Add/Edit Rogue/Friendly AP List

LABEL	DESCRIPTION
MAC	Enter the MAC address of the AP you want to add to the list. A MAC address is a unique hardware identifier in the following hexadecimal format: xx:xx:xx:xx:xx:xx where xx is a hexadecimal number separated by colons.
Description	Enter up to 60 characters for the AP's description. Spaces and underscores are allowed.
Role	Select either Rogue AP or Friendly AP for the AP's role.
OK	Click OK to save your changes back to the Zyxel Device.
Cancel	Click Cancel to close the window with changes unsaved.

11.4 DCS

Use this screen to configure dynamic radio channel selection (see [Dynamic Channel Selection \(DCS\) on page 155](#)). Click **Configuration > Wireless > DCS** to access this screen.

Figure 93 Configuration > Wireless > DCS

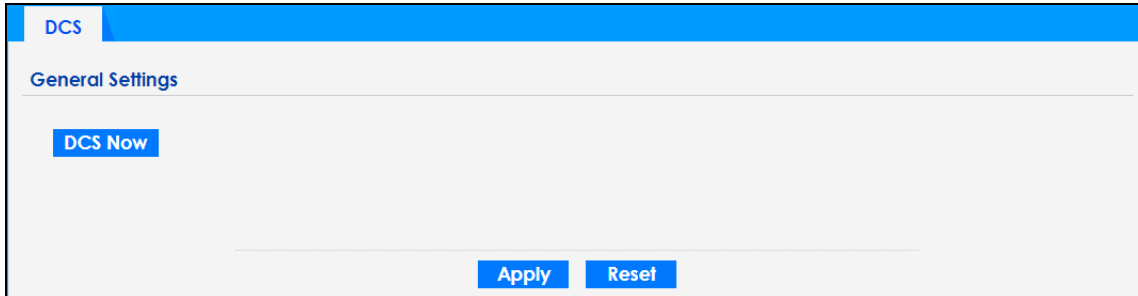

Each field is described in the following table.

Table 54 Configuration > Wireless > DCS

LABEL	DESCRIPTION
DCS Now	Click this to have the Zyxel Device scan for and select an available channel immediately.
Apply	Click Apply to save your changes back to the Zyxel Device.
Reset	Click Reset to return the screen to its last-saved settings.

11.5 Technical Reference

The following section contains additional technical information about the features described in this chapter.

Dynamic Channel Selection

When numerous APs broadcast within a given area, they introduce the possibility of heightened radio interference, especially if some or all of them are broadcasting on the same radio channel. If the interference becomes too great, then the network administrator must open his AP configuration options and manually change the channel to one that no other AP is using (or at least a channel that has a lower level of interference) in order to give the connected stations a minimum degree of interference. Dynamic channel selection frees the network administrator from this task by letting the AP do it automatically. The AP can scan the area around it looking for the channel with the least amount of interference.

In the 2.4 GHz spectrum, each channel from 1 to 13 is broken up into discrete 22 MHz segments that are spaced 5 MHz apart. Channel 1 is centered on 2.412 GHz while channel 13 is centered on 2.472 GHz.

Figure 94 An Example Three-Channel Deployment

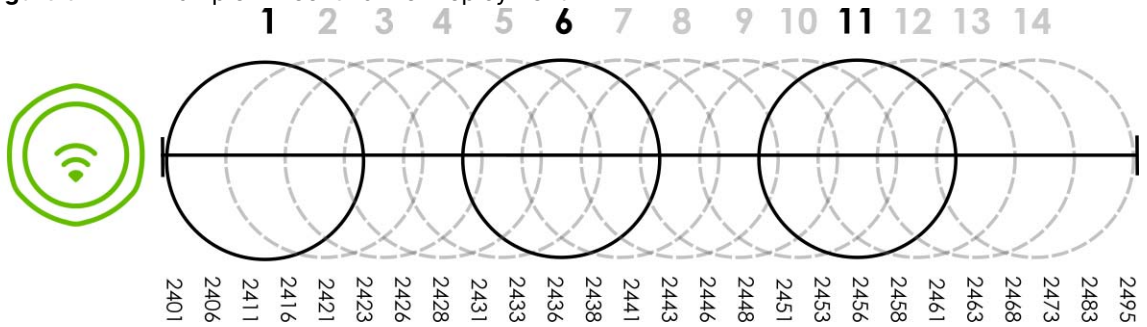

Three channels are situated in such a way as to create almost no interference with one another if used exclusively: 1, 6 and 11. When an AP broadcasts on any of these 3 channels, it should not interfere with neighboring APs as long as they are also limited to same trio.

Figure 95 An Example Four-Channel Deployment

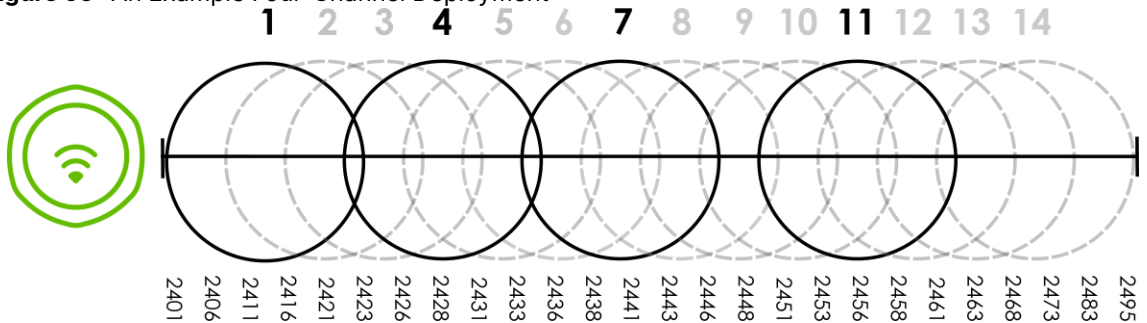

However, some regions require the use of other channels and often use a safety scheme with the following four channels: 1, 4, 7 and 11. While they are situated sufficiently close to both each other and the three so-called “safe” channels (1,6 and 11) that interference becomes inevitable, the severity of it is dependent upon other factors: proximity to the affected AP, signal strength, activity, and so on.

Finally, there is an alternative four channel scheme for ETSI, consisting of channels 1, 5, 9, 13. This offers significantly less overlap than the other one.

Figure 96 An Alternative Four-Channel Deployment

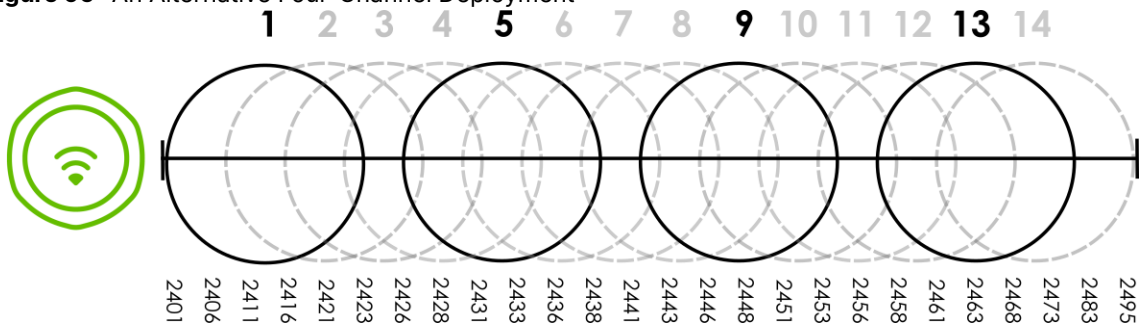

CHAPTER 12

User

12.1 Overview

This chapter describes how to set up user accounts and user settings for the Zyxel Device.

12.1.1 What You Can Do in this Chapter

- The **User** screen (see [User Summary](#)) provides a summary of all user accounts.
- The **Setting** screen (see [Setting](#)) controls default settings, login settings, lockout settings, and other user settings for the Zyxel Device.

12.1.2 What You Need To Know

The following terms and concepts may help as you read this chapter.

User Account

A user account defines the privileges of a user logged into the Zyxel Device. User accounts are used in controlling access to configuration and services in the Zyxel Device.

User Types

These are the types of user accounts the Zyxel Device uses.

Table 55 Types of User Accounts

TYPE	ABILITIES	LOGIN METHOD(S)
Admin Users		
admin	Change Zyxel Device configuration (web, CLI)	WWW, SSH, FTP
limited-admin	Look at Zyxel Device configuration (web, CLI) Perform basic diagnostics (CLI)	WWW, SSH
Access Users		
user	Used for the embedded RADIUS server user access Browse user-mode commands (CLI)	

Note: The default **admin** account is always authenticated locally, regardless of the authentication method setting.

12.2 User Summary

The **User** screen provides a summary of all user accounts. To access this screen click **Configuration > Object > User**.

Figure 97 Configuration > Object > User

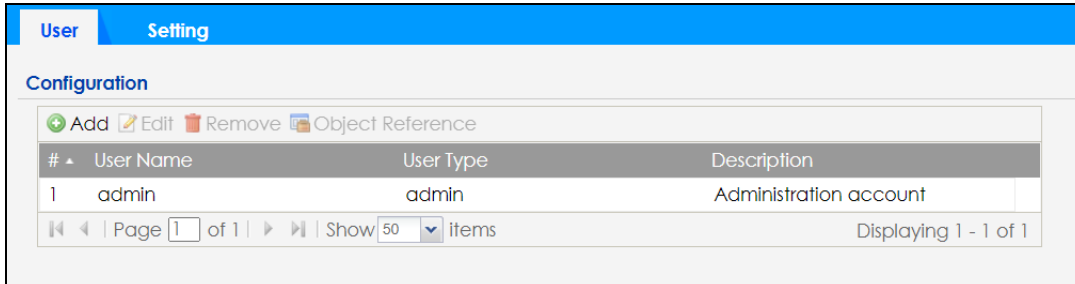

The following table describes the labels in this screen.

Table 56 Configuration > Object > User

LABEL	DESCRIPTION
Add	Click this to create a new entry.
Edit	Double-click an entry or select it and click Edit to open a screen where you can modify the entry's settings.
Remove	To remove an entry, select it and click Remove . The Zyxel Device confirms you want to remove it before doing so.
Object Reference	Select an entry and click Object Reference to open a screen that shows which settings use the entry.
#	This field is a sequential value, and it is not associated with a specific user.
User Name	This field displays the user name of each user.
User Type	This field displays type of user this account was configured as. <ul style="list-style-type: none"> admin - this user can look at and change the configuration of the Zyxel Device limited-admin - this user can look at the configuration of the Zyxel Device but not to change it user - this user has access to the Zyxel Device's services but cannot look at the configuration
Description	This field displays the description for each user.

12.2.1 Add or Edit User

The **User Add or Edit** screen allows you to create a new user account or edit an existing one.

12.2.1.1 Rules for User Names

Enter a user name from 1 to 31 characters.

The user name can only contain the following characters:

- Alphanumeric A-z 0-9 (there is no unicode support)
- _ [underscores]
- - [dashes]

The first character must be alphabetical (A-Z a-z), an underscore (_), or a dash (-). Other limitations on user names are:

- User names are case-sensitive. If you enter a user 'bob' but use 'BOB' when connecting through CIFS or FTP, it will use the account settings used for 'BOB' not 'bob'.
- User names have to be different than user group names.
- Here are the reserved user names:
 - adm
 - admin
 - any
 - bin
 - daemon
 - debug
 - devicehaecived
 - ftp
 - games
 - halt
 - ldap-users
 - lp
 - mail
 - news
 - nobody
 - operator
 - radius-users
 - root
 - shutdown
 - sshd
 - sync
 - uucp
 - zyxel

To access this screen, go to the **User** screen, and click **Add** or **Edit**.

Figure 98 Configuration > Object > User > Add or Edit A User

The following table describes the labels in this screen.

Table 57 Configuration > User > User > Add or Edit a User

LABEL	DESCRIPTION
User Name	Type the user name for this user account. You may use 1-31 alphanumeric characters, underscores(_), or dashes (-), but the first character cannot be a number. This value is case-sensitive. User names have to be different than user group names, and some words are reserved.
User Type	Select what type of user this is. Choices are: <ul style="list-style-type: none"> • admin - this user can look at and change the configuration of the Zyxel Device • limited-admin - this user can look at the configuration of the Zyxel Device but not to change it • user - this is used for embedded RADIUS server user access
Password	Enter the password of this user account. It can consist of 4 to 63 printable characters. Spaces are not allowed.
Retype	Re-enter the password to make sure you have entered it correctly.

Table 57 Configuration > User > User > Add or Edit a User (continued)

LABEL	DESCRIPTION
Description	Enter the description of each user, if any. You can use up to 60 printable ASCII characters. Default descriptions are provided.
Authentication Timeout Settings	This field is not available if the user type is user . If you want to set authentication timeout to a value other than the default settings, select Use Manual Settings then fill your preferred values in the fields that follow. Otherwise, select Use Default Settings to use the default settings displayed below.
Lease Time	This field is not available if the user type is user . Enter the number of minutes this user has to renew the current session before the user is logged out. You can specify 1 to 1440 minutes. You can enter 0 to make the number of minutes unlimited. Admin users renew the session every time the main screen refreshes in the Web Configurator.
Reauthentication Time	This field is not available if the user type is user . Type the number of minutes this user can be logged into the Zyxel Device in one session before the user has to log in again. You can specify 1 to 1440 minutes. You can enter 0 to make the number of minutes unlimited. Unlike Lease Time , the user has no opportunity to renew the session without logging out.
OK	Click OK to save your changes back to the Zyxel Device.
Cancel	Click Cancel to exit this screen without saving your changes.

12.3 Setting

This screen controls default settings, login settings, lockout settings, and other user settings for the Zyxel Device.

To access this screen, login to the Web Configurator, and click **Configuration > Object > User > Setting**.

Figure 99 Configuration > Object > User > Setting

User
Setting

User Default Setting

Default Authentication Timeout Settings

Edit

#	User Type	Lease Time	Reauthentication Time
1	admin	1440	1440
2	limited-admin	1440	1440
3	user	-	-

Page 1 of 1 | Show 50 items | Displaying 1 - 3 of 3

Login Security

Enable Password Complexity

Complexity requirement:

- * Minimum password length should be of 8 characters.
- * Include at least 1 Upper case alphabetic character.
- * Include at least 1 Lower case alphabetic character.
- * Include at least 1 numeric character.
- * Include at least 1 special character like '@', '\$', '!', ...

User Logon Settings

Limit the number of simultaneous logons for administration account

Maximum number per administration account: (1-1034)

User Lockout Settings

Enable logon retry limit

Maximum retry count: (1-99)

Lockout period: (1-65535 minutes)

Apply
Reset

The following table describes the labels in this screen.

Table 58 Configuration > Object > User > Setting

LABEL	DESCRIPTION
User Default Setting	
Default Authentication Timeout Settings	These authentication timeout settings are used by default when you create a new user account. They also control the settings for any existing user accounts that are set to use the default settings. You can still manually configure any user account's authentication timeout settings.
Edit	Double-click an entry or select it and click Edit to open a screen where you can modify the entry's settings.
#	This field is a sequential value, and it is not associated with a specific entry.
User Type	These are the kinds of user account the Zyxel Device supports. <ul style="list-style-type: none"> • admin - this user can look at and change the configuration of the Zyxel Device • limited-admin - this user can look at the configuration of the Zyxel Device but not to change it • user - this is used for embedded RADIUS server user access
Lease Time	This is the default lease time in minutes for each type of user account. It defines the number of minutes the user has to renew the current session before the user is logged out. Admin users renew the session every time the main screen refreshes in the Web Configurator.

Table 58 Configuration > Object > User > Setting (continued)

LABEL	DESCRIPTION
Reauthentication Time	This is the default reauthentication time in minutes for each type of user account. It defines the number of minutes the user can be logged into the Zyxel Device in one session before having to log in again. Unlike Lease Time , the user has no opportunity to renew the session without logging out.
Login Security	
Enable Password Complexity	Select this to enforce the following conditions in a user password. New user accounts will have to set passwords following this complexity rule. The password must consist of at least 8 characters and should include at least: <ul style="list-style-type: none"> • 1 uppercase alphabetic character • 1 lowercase alphabetic character • 1 numeric character • 1 special character like '@','\$','!'... Note: This does not affect the existing accounts.
User Logon Settings	
Limit the number of simultaneous logons for administration account	Select this checkbox if you want to set a limit on the number of simultaneous logins by admin users. If you do not select this, admin users can login as many times as they want at the same time using the same or different IP addresses.
Maximum number per administration account	This field is effective when Limit ... for administration account is checked. Type the maximum number of simultaneous logins by each admin user.
User Lockout Settings	
Enable logon retry limit	Select this checkbox to set a limit on the number of times each user can login unsuccessfully (for example, wrong password) before the IP address is locked out for a specified amount of time.
Maximum retry count	This field is effective when Enable logon retry limit is checked. Type the maximum number of times each user can login unsuccessfully before the IP address is locked out for the specified lockout period . The number must be between 1 and 99.
Lockout period	This field is effective when Enable logon retry limit is checked. Type the number of minutes the user must wait to try to login again, if logon retry limit is enabled and the maximum retry count is reached. This number must be between 1 and 65,535 (about 45.5 days).
Apply	Click Apply to save the changes.
Reset	Click Reset to return the screen to its last-saved settings.

12.3.1 Edit User Authentication Timeout Settings

This screen allows you to set the default authentication timeout settings for the selected type of user account. These default authentication timeout settings also control the settings for any existing user accounts that are set to use the default settings. You can still manually configure any user account's authentication timeout settings.

To access this screen, go to the **Configuration > Object > User > Setting** screen, select one of the **Default Authentication Timeout Settings** entry and click the **Edit** icon.

Figure 100 User > Setting > Edit User Authentication Timeout Settings

Edit User Authentication Timeout Settings

User Type: admin

Lease Time: 1440 (0-1440 minutes, 0 is unlimited)

Reauthentication Time: 1440 (0-1440 minutes, 0 is unlimited)

OK Cancel

The following table describes the labels in this screen.

Table 59 User > Setting > Edit User Authentication Timeout Settings

LABEL	DESCRIPTION
User Type	This read-only field identifies the type of user account for which you are configuring the default settings. <ul style="list-style-type: none"> admin - this user can look at and change the configuration of the Zyxel Device. limited-admin - this user can look at the configuration of the Zyxel Device but not to change it.
Lease Time	Enter the number of minutes this type of user account has to renew the current session before the user is logged out. You can specify 1 to 1440 minutes. You can enter 0 to make the number of minutes unlimited. Admin users renew the session every time the main screen refreshes in the Web Configurator. Access users can renew the session by clicking the Renew button on their screen. If you allow access users to renew time automatically, the users can select this checkbox on their screen as well. In this case, the session is automatically renewed before the lease time expires.
Reauthentication Time	Type the number of minutes this type of user account can be logged into the Zyxel Device in one session before the user has to log in again. You can specify 1 to 1440 minutes. You can enter 0 to make the number of minutes unlimited. Unlike Lease Time , the user has no opportunity to renew the session without logging out.
OK	Click OK to save your changes back to the Zyxel Device.
Cancel	Click Cancel to exit this screen without saving your changes.

CHAPTER 13

AP Profile

13.1 Overview

This chapter shows you how to configure preset profiles for the Zyxel Device.

13.1.1 What You Can Do in this Chapter

- The **Radio** screen ([Radio](#)) creates radio configurations that can be used by the APs.
- The **SSID** screen ([SSID](#)) configures three different types of profiles for your networked APs.

13.1.2 What You Need To Know

The following terms and concepts may help as you read this chapter.

Wireless Profiles

At the heart of all wireless AP configurations on the Zyxel Device are profiles. A profile represents a group of saved settings that you can use across any number of connected APs. You can set up the following wireless profile types:

- **Radio** - This profile type defines the properties of an AP's radio transmitter. You can have a maximum of 64 radio profiles on the Zyxel Device.
- **SSID** - This profile type defines the properties of a single WiFi network signal broadcast by an AP. Each radio on a single AP can broadcast up to 8 SSIDs. You can have a maximum of 64 SSID profiles on the Zyxel Device.
- **Security** - This profile type defines the security settings used by a single SSID. It controls the encryption method required for a WiFi client to associate itself with the SSID. You can have a maximum of 64 security profiles on the Zyxel Device.
- **MAC Filtering** - This profile provides an additional layer of security for an SSID, allowing you to block access or allow access to that SSID based on WiFi client MAC addresses. If a client's MAC address is on the list, then it is either allowed or denied, depending on how you set up the MAC Filter profile. You can have a maximum of 64 MAC filtering profiles on the Zyxel Device.
- **Layer-2 Isolation** - This profile defines the MAC addresses of the devices that you want to allow the associated WiFi clients to have access to when layer-2 isolation is enabled.

SSID

The SSID (Service Set Identifier) is the name that identifies the Service Set with which a wireless station is associated. Wireless stations associating to the access point (AP) must have the same SSID. In other words, it is the name of the WiFi network that clients use to connect to it.

Init SSID

Init (initial) SSID (Service Set Identifier) is the default WiFi network name of the Zyxel Device. The name consists of **Zyxel-xxxx**, where xxxx are the last four characters of the MAC address. You can find the MAC address on the Zyxel Device label.

SSID Forwarding Mode - NAT

NAT (Network Address Translation) mode is the default **Forwarding mode** of the Zyxel Device. This allows the SSID to be visible to your WiFi-enabled computer (**C**) and connect to the Zyxel Device (**AP**). Use this mode to log into the Web Configurator to configure secure SSID on the Zyxel Device (**AP**). Use this mode if you do not have a DHCP server router in your network (for example, router or gateway).

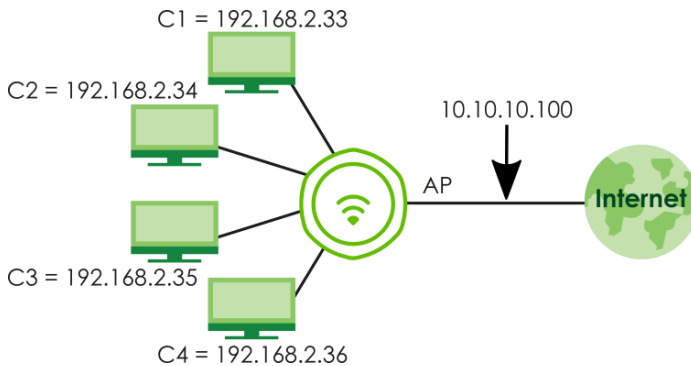

SSID Forwarding Mode - Local Bridge

You can set **Local bridge** as the **Forwarding mode** of the Zyxel Device (**Configuration > Object > AP Profile > SSID > SSID List > Add or Edit SSID Profile**). This allows the connected WiFi client devices (**C1 - C4**) on the Zyxel Device (**AP**) to get individual IP address from the Gateway (**GW**) directly. Use this mode if you already have a gateway in your network.

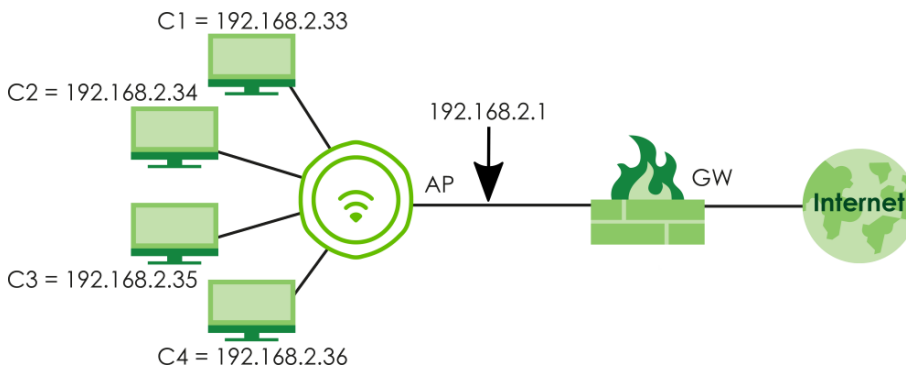

WEP

WEP (Wired Equivalent Privacy) encryption scrambles all data packets transmitted between the AP and the wireless stations associated with it in order to keep network communications private. Both the wireless stations and the access points must use the same WEP key for data encryption and decryption.

WPA2

WPA2 (IEEE 802.11i) is a WiFi security standard that defines stronger encryption, authentication and key management than WPA. Key differences between WPA2 and WEP are improved data encryption and user authentication.

WPA3

WPA3 is a WiFi security standard based on IEEE 802.11i, with security improvements like adopting enhanced PSK (Pre-Shared Key) authentication mechanism.

Personal vs Enterprise

A secure WiFi connection relies on WiFi encryption and authentication. There are two authentication modes: Personal and Enterprise.

Personal mode requires a password called Pre-Shared Key (PSK). Users enter the same PSK to connect to the WiFi network.

Enterprise mode requires an external RADIUS server for authentication. Authentication of user identity is required to connect to the WiFi network.

IEEE 802.1X

The IEEE 802.1X standard outlines enhanced security methods for both the authentication of wireless stations and encryption key management. Authentication is done using an external RADIUS server.

IEEE 802.11k/v Assisted Roaming

IEEE 802.11k is a standard for radio resource management of wireless LANs, which allows clients to request neighbor lists from the connected AP and discover the best available AP when roaming. An 802.11k neighbor list can contain up to six BSSIDs with the highest RCPI (Received Channel Power Indicator) value in both bands (5 GHz and 2.4 GHz, in the ratio of 4:2).

The IEEE 802.11v BSS Transition Management feature lets an AP automatically provide load information of the neighbor APs to clients. It helps the Zyxel Device steer clients to a suitable AP for better performance or load balancing.

WiFi 6 (IEEE 802.11ax)

WiFi 6 (802.11ax) is a WiFi standard that supports both 2.4 GHz and 5 GHz frequency bands and brings the following improvements over WiFi 5:

Faster Data Transmission

WiFi 6 allows faster data transmission using:

- 1024-QAM (Quadrature Amplitude Modulation) – enhances the data capacity of each transmission unit.
- 160 MHz Channel Bandwidth – extends the supported channel bandwidth to 160 MHz, providing higher data throughput.

Enhanced Air Time Utilization

WiFi 6 increases transmission performance in high-density environments, such as a campus or a company office that have multiple client devices using:

- OFDMA (Orthogonal Frequency-Division Multiple Access) – allows multiple WiFi clients to transmit data simultaneously on a single OFDM symbol by dividing sub-carriers into groups as transmission units called Resource Units (RUs). The AP then allocates RUs to different WiFi clients for data transmissions at the same time.
- BSS Coloring – tags traffic by Basic Service Set (BSS) and identifies traffic from overlapping BSSs. The AP can ignore traffic of unrelated BSSs and transmit data when a channel is occupied.
- MU-MIMO (Multiple User-Multiple Input Multiple Output) – enables multiple users to connect to the AP and downlink/uplink traffic simultaneously.

Extended Signal Range

Beamforming – forms the radiating signals into one direction. This enhances the signal strength and extends the signal transmission range.

Extended Battery Life

TWT (Target Wake Time) – The AP negotiates with client devices so client devices only wake up and communicate with the AP in specific periods. This conserves the battery life of client devices.

WiFi 6E (IEEE 802.11ax - Extended Standard)

WiFi 6E is an extended standard of WiFi 6 (IEEE 802.11ax). WiFi 6E inherits all the WiFi 6 features and brings with an additional 6 GHz band. The 6 GHz band allows you to avoid possible congested traffic in the lower 2.4 GHz and 5 GHz bands. WiFi clients must support WiFi 6E to connect to an AP using the 6 GHz band.

You must use WPA3 for security with WiFi 6E.

Note: Check your client device's product specification to see if your client device supports the 6 GHz band (WiFi 6E). If not, you should still use the 2.4/5 GHz bands for connection.

Below is a comparison table that shows the main differences between WiFi 6 and WiFi 6E.

Table 60 WiFi 6 and WiFi 6E Comparison

FEATURES		WIFI 6	WIFI 6E
Theoretical Maximum Speed (Up-to)		The same (9.6 Gbps).	
Supported Frequency Bands		2.4 GHz/5 GHz	2.4 GHz/5 GHz/6 GHz
Supported Channel Bandwidth		20/40/80/160 MHz	20/40/80/160 MHz
Total Spectrum (Up-to)	2.4 GHz	80 MHz	
	5 GHz	500 MHz	
	6 GHz	Not supported.	1200 MHz
Other Features (OFDMA/BSS Coloring/TWT/Two-Way MU-MIMO/Beamforming/1024-QAM)		The same (WiFi 6E inherits all the features from WiFi 6).	

WiFi 6E MBSSID Beacon Management

The Zyxel Device supports MBSSID (see [MBSSID](#)), which allows you to create multiple virtual WiFi networks (SSIDs) on the Zyxel Device. With the WiFi 6E (802.11ax-extended) standard, the Zyxel Device divides SSIDs into groups, and includes information of all SSIDs in a group in one SSID beacon. Therefore, the Zyxel Device doesn't need to send beacons for individual SSIDs, which improves air time efficiency.

Note: If you disable a virtual WiFi network (SSID) whose beacon contains the group SSID information, WiFi clients of that group will be disconnected until the AP reselects another SSID to send the beacon.

Out-of-Band Discovery

Out-of-band discovery allows the AP to include information of the 6 GHz band in management frames sent over the 2.4 GHz /5 GHz bands. WiFi 6E clients only need to scan the lower bands (2.4 GHz/5 GHz) to connect to the AP in the 6 GHz band, reducing the discovery time.

PSC Channel (In-Band Discovery)

PSCs (Preferred Scanning Channels) are dedicated channels for WiFi 6E clients to send probe requests on to discover a compatible AP, instead of scanning the entire 6 GHz band. In this way, WiFi 6E clients are able to efficiently discover and connect to the AP within the 6 GHz band.

Note: The available PSCs differ by country for the unlicensed use in the 6 GHz band.

Resource Unit

A resource unit is a portion of a channel bandwidth. For example, a 20 MHz channel can be divided into several resource units. Each resource unit can be allocated to a specified WiFi client, allowing simultaneous data transmission.

WiFi 7 (IEEE802.11be)

WiFi 7 (802.11be) is backward-s compatible with WiFi 6 and WiFi 6E. WiFi 7 is a WiFi standard that supports 2.4 GHz, 5 GHz and 6 GHz frequency bands with the following improvements over WiFi 6 and WiFi 6E.

Table 61 WiFi 6, WiFi 6E and WiFi 7 Comparison

FEATURES	WIFI 6	WIFI 6E	WIFI 7
Theoretical Maximum Speed (Up-to)	The same (9.6 Gbps).		46 Gbps
Supported Frequency Bands	2.4 GHz/5 GHz	2.4 GHz/5 GHz/6 GHz	2.4 GHz/5 GHz/6 GHz
Supported Channel Bandwidth	20/40/80/160 MHz	20/40/80/160 MHz	20/40/80/160/320 MHz

Table 61 WiFi 6, WiFi 6E and WiFi 7 Comparison

FEATURES		WIFI 6	WIFI 6E	WIFI 7
Total Spectrum (Up-to)	2.4 GHz	80 MHz		80 MHz
	5 GHz	500 MHz		500 MHz
	6 GHz	Not supported.	1200 MHz	1200 MHz
Other Features (OFDMA/BSS Coloring/TWT/Two-Way MU-MIMO/Beamforming/1024-QAM)		The same (WiFi 6E inherits all the features from WiFi 6).		WiFi 7 inherits all the features from WiFi 6 and WiFi 6E, with the addition of multi-link operation and preamble puncturing.

Faster Data Transmission

WiFi 7 allows faster data transmission using:

- 4096 QAM (Quadrature Amplitude Modulation)- enhances the amount of data transmitted over the available bandwidth.
- 320 MHz Channel Bandwidth- enlarges the supported channel bandwidth to 320 MHz, allowing higher data throughput.
- Multiple Resource Units (RUs)- allows an AP to allocate multiple RUs to a WiFi client.

Multi-Link Operation (MLO)

An AP can support multiple frequency bands (2.4 GHz, 5 GHz and 6 GHz), but a WiFi client can only connect to the AP using one of these frequency bands. The other frequency bands are unused. The client's data transmission speed depends on the frequency band they are connected to.

Figure 101 Without Multi-Link Operation

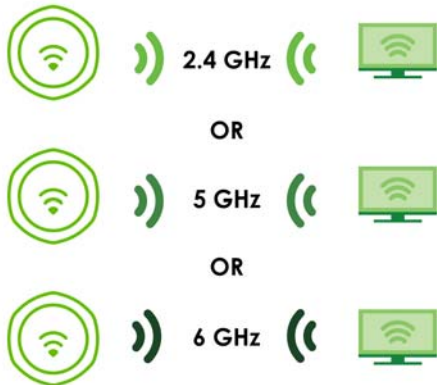

WiFi 7 MLO allows a WiFi client to connect to the AP using multiple frequency bands simultaneously. This increases speed and improves reliability of the WiFi connection. MLO makes WiFi 7 ideal for streaming 4K/8K videos, using augmented reality (AR), virtual reality (VR) applications and playing online games.

To use MLO, both the AP and the WiFi client have to support MLO.

Note: Not all Zyxel Device models support MLO feature. See the comparison table in [Zyxel Device Product Feature Comparison](#). You can only set up MLO through NCC or the CLI. See NCC User's Guide or the Command Reference Guide for more information.

Figure 102 Multi-Link Operation Example



Preamble Puncturing

In WiFi 6 and earlier, any interference would cause the entire WiFi channel to become unavailable. In the figure below, if part of the WiFi channel (B) experiences interference, the rest of the WiFi channel (C) becomes unavailable.

Figure 103 Without Preamble Puncturing



WiFi 7 preamble puncturing allows you to block the specific portion of the channel that is experiencing interference while continuing to use the rest of the WiFi channel. In the figure below, if part of the WiFi channel (B) experiences interference, the rest of the WiFi channel (C) is still available.

Figure 104 Preamble Puncturing Example



13.2 Radio

This screen allows you to create radio profiles for the Zyxel Device. A radio profile is a list of settings that an Zyxel Device Profile can use to configure its radio transmitter(s). To access this screen click **Configuration > Object > AP Profile**.

Note: You can have a maximum of 64 radio profiles on the Zyxel Device.

Figure 105 Configuration > Object > AP Profile > Radio (for 2.4 GHz and 5 GHz models)

#	Status	Profile Name	Frequency B...	Operating Mo...
1	Inactive	default	2.4G	MBSSID
2	Inactive	default2	5G	MBSSID

Figure 106 Configuration > Object > AP Profile > Radio (for 2.4 GHz, 5 GHz, and 6 GHz models)

The screenshot shows a web interface for configuring radio profiles. At the top, there are tabs for 'Radio' and 'SSID'. Below the tabs is a 'Radio Summary' section with a toolbar containing buttons for 'Add', 'Edit', 'Remove', 'Activate', 'Inactivate', and 'Object Reference'. A table lists five radio profiles with columns for '#', 'Status', 'Profile Name', and 'Frequency Band'. The status column shows yellow lightbulb icons for all entries. At the bottom of the table, there is a pagination control showing 'Page 1 of 1' and 'Show 50 items', and a status indicator 'Displaying 1 - 5 of 5'.

#	Status	Profile Name	Frequency Band
1	🟡	Wiz_Radio_5G	5G
2	🟡	Wiz_Radio_6G	6G
3	🟡	Wiz_Radio_24G	2.4G
4	🟡	default	2.4G
5	🟡	default2	5G

The following table describes the labels in this screen.

Table 62 Configuration > Object > AP Profile > Radio

LABEL	DESCRIPTION
Add	Click this to add a new radio profile.
Edit	Click this to edit the selected radio profile.
Remove	Click this to remove the selected radio profile.
Activate	To turn on an entry, select it and click Activate .
Inactivate	To turn off an entry, select it and click Inactivate .
Object Reference	Click this to view which other objects are linked to the selected radio profile.
#	This field is a sequential value, and it is not associated with a specific user.
Status	This field shows whether or not the entry is activated. A yellow bulb signifies that this rule is active. A gray bulb signifies that this rule is not active.
Profile Name	This field indicates the name assigned to the radio profile.
Frequency Band	This field indicates the frequency band which this radio profile is configured to use.
Operating Mode	This indicates the radio's operating mode. Operating modes are AP (MBSSID) , Root AP or Repeater .
Apply	Click Apply to save your changes back to the Zyxel Device.
Reset	Click Reset to return the screen to its last-saved settings.

13.2.1 Add or Edit Radio Profile

This screen allows you to create a new radio profile or edit an existing one. To access this screen, click the **Add** button or select a radio profile from the list and click the **Edit** button.

Figure 107 Configuration > Object > AP Profile > Radio > Add or Edit (for 2.4 GHz and 5GHz models)

Add Radio Profile ? X

Hide Advanced Settings

General Settings

Activate

Profile Name:

802.11 Band: 2.4G 5G

802.11 mode:

Channel Width:

Channel Selection: DCS Manual

Enable DCS Client Aware

2.4 GHz Channel Selection Method:

2.4 GHz Channel Deployment:

Time Interval

Schedule

Start Time:

Week Days: Monday Tuesday Wednesday
 Thursday Friday Saturday
 Sunday

Advanced Settings

Enable A-MPDU Aggregation

Enable A-MSDU Aggregation

RTS/CTS Threshold: (0~2347)

Beacon Interval: (40ms~1000ms)

DTIM: (1~255)

Enable Signal Threshold

Disassociate Station Threshold: dbm (-20 ~ -105)

Disassociate Aggressiveness:

Allow 802.11n/ac/ax stations only i

Enable 802.11d BETA i

Multicast Settings

Transmission Mode: Multicast to Unicast Fixed Multicast Rate

Multicast Rate(Mbps): 1 2 5.5 11 6 9 12 18
 24 36 48 54

Minimum WLAN Rate Control Setting BETA i

1 2 5.5 6 9 11 12 18
 24 36 48 54

Figure 108 Configuration > Object > AP Profile > Radio > Add or Edit (for 2.4 GHz, 5 GHz and 6 GHz models)

Add Radio Profile
?
X

Hide Advanced Settings

General Settings

Activate

Profile Name:

802.11 Band: 2.4G 5G 6G

802.11 mode:

Channel Width:

160MHz support i

Channel Selection: DCS Manual

Enable DCS Client Aware

6 GHz Channel Selection Method::

Time Interval

Schedule

Start Time:

Week Days: Monday Tuesday Wednesday
 Thursday Friday Saturday
 Sunday

Advanced Settings

Enable A-MPDU Aggregation

Enable A-MSDU Aggregation

RTS/CTS Threshold: (0~2347)

Beacon Interval: (40ms~1000ms)

DTIM: (1~255)

Enable Signal Threshold

Disassociate Station Threshold: dbm (-20 ~ -105)

Disassociate Aggressiveness:

Enable 802.11d i

Multicast Settings

Transmission Mode: Multicast to Unicast Fixed Multicast Rate

Multicast Rate(Mbps): 6 9 12 18 24 36 48 54

Minimum WLAN Rate Control Setting i

6 9 12 18 24 36 48 54

The following table describes the labels in this screen.

Table 63 Configuration > Object > AP Profile > Radio > Add or Edit

LABEL	DESCRIPTION
Hide / Show Advanced Settings	Click this to hide or show the Advanced Settings in this window.
General Settings	
Activate	Select this option to make this profile active.
Profile Name	Enter up to 31 alphanumeric characters to be used as this profile's name. Spaces and underscores are allowed.
802.11 Band	Select whether this radio would use the 2.4 GHz or 5 GHz band.
802.11 Mode	<p>Select how to let WiFi clients connect to the AP.</p> <p>If 802.11 Band is set to 2.4G:</p> <ul style="list-style-type: none"> • 11b/g: allows either IEEE 802.11b or IEEE 802.11g compliant WLAN devices to associate with the Zyxel Device. The Zyxel Device adjusts the transmission rate automatically according to the WiFi standard supported by the wireless devices. • 11n: allows IEEE802.11b, IEEE802.11g and IEEE802.11n compliant WLAN devices to associate with the Zyxel Device. • 11ax: allows IEEE802.11b, IEEE802.11g, IEEE802.11n, and IEEE802.11ax compliant WLAN devices to associate with the Zyxel Device. If the WLAN device isn't compatible with 802.11ax, the Zyxel Device will communicate with the WLAN device using 802.11n, and so on. • 11be: allows IEEE802.11b, IEEE802.11g, IEEE802.11n, IEEE802.11ax and IEEE802.11be compliant WLAN devices to associate with the Zyxel Device. If the WLAN device isn't compatible with 802.11be, the Zyxel Device will communicate with the WLAN device using 802.11ax, and so on. <p>If 802.11 Band is set to 5G:</p> <ul style="list-style-type: none"> • 11a: allows only IEEE 802.11a compliant WLAN devices to associate with the Zyxel Device. • 11n: allows both IEEE802.11n and IEEE802.11a compliant WLAN devices to associate with the Zyxel Device. • 11ac: allows IEEE802.11n, IEEE802.11a, and IEEE802.11ac compliant WLAN devices to associate with the Zyxel Device. If the WLAN device isn't compatible with 802.11ac, the Zyxel Device will communicate with the WLAN device using 802.11n, and so on. • 11ax: allows IEEE802.11n, IEEE802.11a, IEEE802.11ac, and IEEE802.11ax compliant WLAN devices to associate with the Zyxel Device. If the WLAN device isn't compatible with 802.11ax, the Zyxel Device will communicate with the WLAN device using 802.11ac, and so on. • 11be: allows IEEE802.11a, IEEE802.11n, IEEE802.11ac, IEEE802.11ax and IEEE802.11be compliant WLAN devices to associate with the Zyxel Device. If the WLAN device isn't compatible with 802.11be, the Zyxel Device will communicate with the WLAN device using 802.11ax, and so on. <p>If 802.11 Band is set to 6G:</p> <ul style="list-style-type: none"> • 11ax: allows IEEE802.11ax compliant WLAN devices to associate with the Zyxel Device. • 11be: allows IEEE802.11be compliant WLAN devices to associate with the Zyxel Device. If the WLAN device isn't compatible with 802.11be, the Zyxel Device will communicate with the WLAN device using 802.11ax.

Table 63 Configuration > Object > AP Profile > Radio > Add or Edit (continued)

LABEL	DESCRIPTION
Channel Width	<p>Select the channel bandwidth you want to use for your WiFi network. See Zyxel Device Product Feature Comparison to see the channel bandwidth your Zyxel Device supports.</p> <p>Select 20MHz if you want to lessen radio interference with other wireless devices in your neighborhood.</p> <p>Select 40MHz to allow the Zyxel Device to choose the channel bandwidth (20 or 40 MHz) that has least interference.</p> <p>Select 80MHz to allow the Zyxel Device to choose the channel bandwidth (20, 40 or 80) that has least interference. This option is available only when you select 11ac or 11ax in the 802.11 Mode field.</p> <p>Select 160MHz to allow the Zyxel Device to choose the channel bandwidth (20, 40, 80 or 160MHz) that has least interference. This option is available only when you select 11ax or 11be in the 802.11 Mode field.</p> <p>Select 240MHz to allow the Zyxel Device to choose the channel bandwidth (20, 40, 80, 160 or 240MHz) that has least interference. This option is available only when you set 802.11 Band to 5G, and select 11ax or 11be in the 802.11 Mode field.</p> <p>Select 320MHz to allow the Zyxel Device to choose the channel bandwidth (20, 40, 80, 160, 240 or 320 MHz) that has least interference. This option is available only when you set 802.11 Band to 6G, and select 11be in the 802.11 Mode field.</p> <p>Note: If the environment has poor signal-to-noise ratio (SNR), the Zyxel Device will switch to a lower bandwidth.</p>
Channel Selection	<p>This is the radio channel which the signal will use for broadcasting by this radio profile.</p> <ul style="list-style-type: none"> • DCS: Choose Dynamic Channel Selection to have the Zyxel Device choose a radio channel that has least interference. • Manual: Choose from the available radio channels in the list. If your Zyxel Device is outdoor type, be sure to choose non-indoors channels.
Enable DCS Client Aware	<p>This field is available when you set Channel Selection to DCS.</p> <p>Select this to have the Zyxel Device switch channels only when there are no clients connected to it. If there is a client connected, the Zyxel Device will not switch channels but generate a log. The Zyxel Device tries to scan and switch channels again at the end of the specified time interval or at the scheduled time.</p> <p>If you disable this then the Zyxel Device switches channels immediately regardless of any client connections. In this instance, clients that are connected to the Zyxel Device are dropped when it switches channels.</p>
2.4 GHz Channel Selection Method	<p>This field is available when you set 802.11 Band to 2.4G and Channel Selection to DCS.</p> <p>Select how you want to specify the channels the Zyxel Device switches between for 2.4 GHz operation.</p> <p>Select auto to have the Zyxel Device display a 2.4 GHz Channel Deployment field you can use to limit channel switching to 3 or 4 channels.</p> <p>Select manual to select the individual channels the Zyxel Device switches between.</p> <p>Note: The method is automatically set to auto when no channel is selected or any one of the previously selected channels is not supported.</p>
Channel ID	<p>This field is available only when you set Channel Selection to DCS and set 2.4 GHz Channel Selection Method to manual.</p> <p>Select the channels that you want the Zyxel Device to use.</p>

Table 63 Configuration > Object > AP Profile > Radio > Add or Edit (continued)

LABEL	DESCRIPTION
2.4 GHz Channel Deployment	<p>This is available when you set 802.11 Band to 2.4G, Channel Selection to DCS, and 2.4 GHz Channel Selection Method to auto.</p> <p>Select Three-Channel Deployment to limit channel switching to channels 1,6, and 11, the three channels that are sufficiently attenuated to have almost no impact on one another. In other words, this allows you to minimize channel interference by limiting channel-hopping to these three "safe" channels.</p> <p>Select Four-Channel Deployment to limit channel switching to four channels. Depending on the country domain, if the only allowable channels are 1-11 then the Zyxel Device uses channels 1, 4, 7, 11 in this configuration; otherwise, the Zyxel Device uses channels 1, 5, 9, 13 in this configuration. Four channel deployment expands your pool of possible channels while keeping the channel interference to a minimum.</p>
Avoid 5G DFS Channel	<p>This field is available only when you set 802.11 Band to 5G, Channel Selection to DCS and 5 GHz Channel Selection Method to auto.</p> <p>Dynamic Frequency Selection (DFS) is a WiFi channel allocation scheme that allows APs to use channels in the 5 GHz band normally reserved for radar. Before using a DFS channel, an AP must ensure there is no radar present by performing a Channel Availability Check (CAC). This check takes 1-10 minutes, depending on the country in which the AP is located.</p> <p>Select this if you don't want to wait for the Zyxel Device to perform a CAC before using a channel by forcing the Zyxel Device to only use the non-DFS channels.</p> <p>Clear this to allow the Zyxel Device to use the DFS channels for more channel options. The Zyxel Device only switches to a DFS channel when a nearby AP is broadcasting the same SSID the Zyxel Device uses. This allows WiFi clients to switch to connect to the same SSID on another AP when the Zyxel Device is under the CAC process before switching to a DFS channel.</p>
5 GHz Channel Selection Method	<p>Select how you want to specify the channels the Zyxel Device switches between for 5 GHz operation.</p> <p>Select Auto to have the Zyxel Device automatically select the best channel.</p> <p>Select manual to select the individual channels the Zyxel Device switches between.</p> <p>Note: The method is automatically set to auto when no channel is selected or any one of the previously selected channels is not supported.</p>
Channel ID	<p>This field is available only when you set Channel Selection to DCS and set 5 GHz Channel Selection Method to manual.</p> <p>Select the channels that you want the Zyxel Device to use.</p>
6 GHz Channel Selection Method	<p>This field is available only when you set 802.11 Band to 6G, Channel Selection to DCS.</p> <p>Select how you want to specify the channels the Zyxel Device switches between for 6 GHz operation.</p> <p>Select auto to have the Zyxel Device automatically select the best channel.</p> <p>Select manual to select the individual channels the Zyxel Device switches between.</p> <p>Note: The method is automatically set to auto when no channel is selected or any one of the previously selected channels is not supported.</p>
Channel ID	<p>This field is available only when you set Channel Selection to DCS and set 6 GHz Channel Selection Method to manual.</p> <p>Select the channels that you want the Zyxel Device to use.</p>
Time Interval	<p>Select this option to have the Zyxel Device survey the other APs within its broadcast radius at the end of the specified time interval.</p>

Table 63 Configuration > Object > AP Profile > Radio > Add or Edit (continued)

LABEL	DESCRIPTION
DCS Time Interval	<p>This field is available when you set Channel Selection to DCS and select the Time Interval option.</p> <p>Enter a number of minutes. This regulates how often the Zyxel Device surveys the other APs within its broadcast radius. If the channel on which it is currently broadcasting suddenly comes into use by another AP, the Zyxel Device will then dynamically select the next available clean channel or a channel with lower interference.</p>
Schedule	<p>Select this option to have the Zyxel Device survey the other APs within its broadcast radius at a specific time on selected days of the week.</p>
Start Time	<p>Specify the time of the day (in 24-hour format) to have the Zyxel Device use DCS to automatically scan and find a less-used channel.</p>
Week Days	<p>Select each day of the week to have the Zyxel Device use DCS to automatically scan and find a less-used channel.</p>
Advanced Settings	
Guard Interval	<p>This field is available only when the channel width is 20 MHz, 20/40 MHz or 20/40/80 MHz and the 802.11 Mode is either 11n or 11ac.</p> <p>Set the guard interval for this radio profile to either short or long.</p> <p>The guard interval is the gap introduced between data transmission from users in order to reduce interference. Reducing the interval increases data transfer rates but also increases interference. Increasing the interval reduces data transfer rates but also reduces interference.</p>
Enable A-MPDU Aggregation	<p>This field is not available when you set 802.11 Mode to 11a or 11b/g.</p> <p>Select this to enable A-MPDU aggregation.</p> <p>Message Protocol Data Unit (MPDU) aggregation collects Ethernet frames along with their 802.11n headers and wraps them in a 802.11n MAC header. This method is useful for increasing bandwidth throughput in environments that are prone to high error rates.</p>
Enable A-MSDU Aggregation	<p>This field is not available when you set 802.11 Mode to 11a or 11b/g.</p> <p>Select this to enable A-MSDU aggregation.</p> <p>Mac Service Data Unit (MSDU) aggregation collects Ethernet frames without any of their 802.11n headers and wraps the header-less payload in a single 802.11n MAC header. This method is useful for increasing bandwidth throughput. It is also more efficient than A-MPDU except in environments that are prone to high error rates.</p>
RTS/CTS Threshold	<p>Use RTS/CTS to reduce data collisions on the WiFi network if you have WiFi clients that are associated with the same AP but out of range of one another. When enabled, a WiFi client sends an RTS (Request To Send) and then waits for a CTS (Clear To Send) before it transmits. This stops WiFi clients from transmitting packets at the same time (and causing data collisions).</p> <p>A WiFi client sends an RTS for all packets larger than the number (of bytes) that you enter here. Set the RTS/CTS equal to or higher than the Fragmentation Threshold to turn RTS/CTS off.</p>
Fragmentation Threshold	<p>This field is only available when you set 802.11 Mode to 11a or 11b/g.</p> <p>A fragmentation threshold is the maximum data fragment size (between 256 and 2436 bytes) that can be sent in the WiFi network before the AP will fragment the packet into smaller data frames.</p> <p>A large fragmentation threshold is recommended for networks not prone to interference. A smaller threshold is recommended for busy networks or networks that are prone to interference.</p>

Table 63 Configuration > Object > AP Profile > Radio > Add or Edit (continued)

LABEL	DESCRIPTION
Beacon Interval	When a wirelessly networked device sends a beacon, it includes with it a beacon interval. This specifies the time period before the Zyxel Device sends the beacon again. The interval tells receiving devices on the network how long they can wait in low-power mode before waking up to handle the beacon. A high value helps save current consumption of the access point.
DTIM	Delivery Traffic Indication Message (DTIM) is the time period after which broadcast and multicast packets are transmitted to mobile clients in the Active Power Management mode. A high DTIM value can cause clients to lose connectivity with the network. This value can be set from 1 to 255.
Enable Signal Threshold	<p>Select the checkbox to use the signal threshold to ensure WiFi clients receive good throughput. This allows only WiFi clients with strong signals to connect to the Zyxel Device. The Zyxel Device will disconnect WiFi clients with signal strengths lower than the Disassociate Station Threshold you specify.</p> <p>Clear the checkbox to not require WiFi clients to have a minimum signal strength to keep their connections with the Zyxel Device.</p>
Disassociate Station Threshold	<p>Set a minimum kick-off signal strength. You can set from -20dBm (the strongest signal) to -105dBm (the weakest signal).</p> <p>When a WiFi client's signal strength is lower than the specified threshold, the Zyxel Device checks the traffic between the Zyxel Device and the WiFi client. The Zyxel Device will only disconnect the WiFi client when</p> <ul style="list-style-type: none"> • the WiFi client signal strength falls below the kick-off strength and • the WiFi client's traffic throughput is below a minimum threshold. <p>You can set the WiFi client's minimum traffic throughput threshold in Disassociate Aggressiveness.</p>
Disassociate Aggressiveness	<p>Set the minimum traffic throughput threshold here.</p> <p>High: Select this if you don't want the Zyxel Device to disconnect a WiFi client with a weak signal strength (below the kick-off threshold) when the traffic between the Zyxel Device and the WiFi client is heavy. The Zyxel Device will disconnect the WiFi client if the traffic between the Zyxel Device and the WiFi client is medium or low.</p> <p>Standard: Select this if you don't want the Zyxel Device to disconnect a WiFi client with a weak signal strength (below the kick-off threshold) when the traffic between the Zyxel Device and the WiFi client is medium. The Zyxel Device will disconnect the WiFi client if the traffic between the Zyxel Device and the WiFi client is low.</p> <p>Low: Select this if you don't want the Zyxel Device to disconnect a WiFi client with a weak signal strength (below the kick-off threshold) when the traffic between the Zyxel Device and the WiFi client is low. At the time of writing, the Zyxel Device will disconnect the WiFi client if there's no packet sent between the Zyxel Device and the WiFi client in one second.</p>
Allow 802.11n/ac/ax stations only	Select this option to allow only 802.11 n/ac/ax clients to connect, and reject 802.11a/b/g clients.
Blacklist DFS channels in presence of radar	<p>This field is available if 802.11 Band is set to 5G and Channel Selection is set to DCS.</p> <p>Enable this to temporarily blacklist the wireless channels in the Dynamic Frequency Selection (DFS) range whenever a radar signal is detected by the Zyxel Device.</p>
Enable 802.11d	<p>Clear the checkbox to prevent the AP from broadcasting a country code, also called a country Information Element (IE), in beacon frames. This makes the AP incompatible with 802.11d networks and devices.</p> <p>802.11d is a WiFi network specification that allows the AP to broadcast a country code to WiFi client. The country code indicates where the AP is located. If WiFi clients are unable to connect to the AP due to an incompatible country code, you should disable 802.11d.</p>
Multicast Settings	

Table 63 Configuration > Object > AP Profile > Radio > Add or Edit (continued)

LABEL	DESCRIPTION
Transmission Mode	<p>Specify how the Zyxel Device handles wireless multicast traffic.</p> <p>Select Multicast to Unicast to broadcast wireless multicast traffic to all of the WiFi clients as unicast traffic. Unicast traffic dynamically changes the data rate based on the application's bandwidth requirements. The retransmit mechanism of unicast traffic provides more reliable transmission of the multicast traffic, although it also produces duplicate packets.</p> <p>Select Fixed Multicast Rate to send multicast traffic to all WiFi clients at a single data rate. You must know the multicast application's bandwidth requirements and set it in the following field.</p>
Multicast Rate(Mbps)	<p>If you set Transmission Mode to Fixed Multicast Rate, select a data rate at which the Zyxel Device transmits multicast packets to WiFi clients. For example, to deploy 4 Mbps video, select a fixed multicast rate higher than 4 Mbps.</p>
Minimum WLAN Rate Control Setting	<p>Sets the minimum data rate that 2.4 GHz WiFi clients can connect at, in Mbps. At the time of write, allowed values are: 1, 2, 5, 6, 9, 11, 12, 18, 24, 36, 48, 54.</p> <p>Sets the minimum data rate that 5 GHz WiFi clients can connect at, in Mbps. At the time of write, allowed values are: 6, 9, 12, 18, 24, 36, 48, 54.</p> <p>Increasing the minimum data rate can reduce network overhead and improve WiFi network performance in high density environments. However, WiFi clients that do not support the minimum data rate will not be able to connect to the AP.</p>
OK	<p>Click OK to save your changes back to the Zyxel Device.</p>
Cancel	<p>Click Cancel to exit this screen without saving your changes.</p>

13.3 SSID

The SSID screens allow you to configure three different types of profiles for your networked APs: an SSID list, which can assign specific SSID configurations to your APs; a security list, which can assign specific encryption methods to the APs when allowing WiFi clients to connect to them; and a MAC filter list, which can limit connections to an AP based on WiFi clients MAC addresses.

13.3.1 SSID List

This screen allows you to create and manage SSID configurations that can be used by the APs. An SSID, or Service Set Identifier, is basically the name of the WiFi network to which a WiFi client can connect. The SSID appears as readable text to any device capable of scanning for wireless frequencies (such as the WiFi adapter in a laptop), and is displayed as the WiFi network name when a person makes a connection to it.

To access this screen, click **Configuration > Object > AP Profile > SSID > SSID List**.

Note: You cannot add or remove an SSID profile after running the setup wizard.

Figure 109 Configuration > Object > AP Profile > SSID > SSID List (Default)

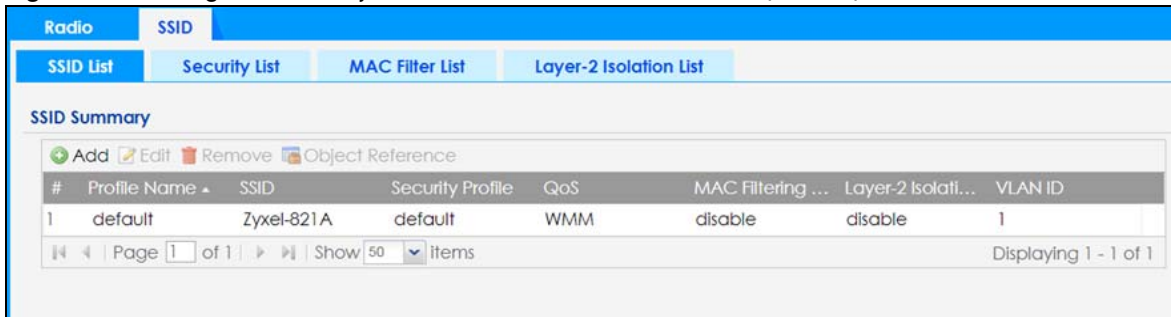
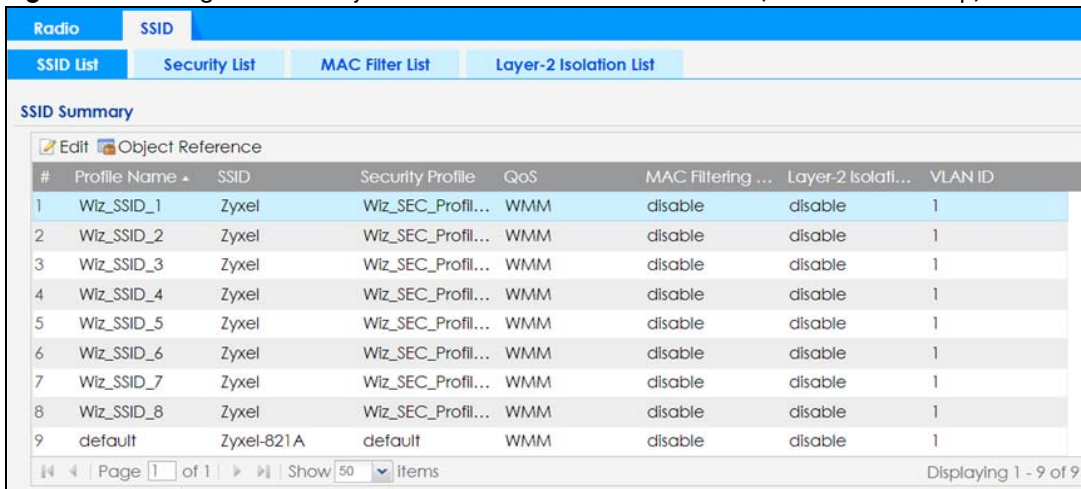

Figure 110 Configuration > Object > AP Profile > SSID > SSID List (After wizard setup)



The following table describes the labels in this screen.

Table 64 Configuration > Object > AP Profile > SSID > SSID List

LABEL	DESCRIPTION
Add	Click this to add a new SSID profile. This button is not available after you configure the Zyxel Device using the wizard.
Edit	Click this to edit the selected SSID profile.
Remove	Click this to remove the selected SSID profile. This button is not available after you configure the Zyxel Device using the wizard.
Object Reference	Click this to view which other objects are linked to the selected SSID profile (for example, radio profile).
#	This field is a sequential value, and it is not associated with a specific user.
Profile Name	This field indicates the name assigned to the SSID profile.
SSID	This field indicates the SSID name as it appears to WiFi clients.
Security Profile	This field indicates which (if any) security profile is associated with the SSID profile.
QoS	This field indicates the QoS type associated with the SSID profile.
MAC Filtering Profile	This field indicates which (if any) MAC filter Profile is associated with the SSID profile.
Layer-2 Isolation Profile	This field indicates which (if any) layer-2 isolation Profile is associated with the SSID profile.
VLAN ID	This field indicates the VLAN ID associated with the SSID profile.

13.3.2 Add or Edit SSID Profile

This screen allows you to create a new SSID profile or edit an existing one. To access this screen, click the **Add** button or select a SSID profile from the list and click the **Edit** button.

Figure 111 Configuration > Object > AP Profile > SSID > SSID List > Add or Edit SSID Profile (for 2.4 GHz and 5 GHz models)

Add SSID Profile

Create new Object▼

Profile Name: ⓘ

SSID:

Band: 2.4G 5G

Security Profile: + ✎

MAC Filtering Profile: +

Layer-2 Isolation Profile: +

QoS:

Rate Limiting (Per Station Traffic Rate)

Downlink: (0~160, 0 is unlimited)

Uplink: (0~160, 0 is unlimited)

VLAN ID: (1~4094)

Hidden SSID

Enable Intra-BSS Traffic blocking

Enable U-APSD

802.11k/v Assisted Roaming

Schedule SSID

OK Cancel

Figure 112 Configuration > Object > AP Profile > SSID > SSID List > Add or Edit SSID Profile (for 2.4 GHz, 5 GHz, and 6 GHz models)

The following table describes the labels in this screen.

Table 65 Configuration > Object > AP Profile > SSID > SSID List > Add or Edit SSID Profile

LABEL	DESCRIPTION
Create new Object	Select an object type from the list to create a new one associated with this SSID profile.
Profile Name	Enter up to 31 alphanumeric characters for the profile name. This name is only visible in the Web Configurator and is only for management purposes. Spaces and underscores are allowed.
SSID	Enter the SSID name for this profile. This is the name visible on the network to WiFi clients. Enter up to 32 characters, spaces and underscores are allowed.
Band	Select the radio bands to which the SSID profile is applicable. The profile will only work on the radio bands you select. For example, you select 5G for the SSID profile "Wiz_SSID_1", and apply it on radio 2 (with a radio profile using the 6 GHz band). The SSID profile will not take effect until you set radio 2 to use the 5 GHz band.

Table 65 Configuration > Object > AP Profile > SSID > SSID List > Add or Edit SSID Profile (continued)

LABEL	DESCRIPTION
Forwarding Mode	<p>Select Local bridge if you only want to access the Internet. Network traffic from clients connected to the Zyxel Device is sent directly to the network through the local gateway.</p> <p>Select NAT mode to have the Zyxel Device create a DHCP subnet with its own NAT for the SSID. This simplifies WiFi network management, as you do not need to configure a separate DHCP server.</p>
Security Profile	<p>Select a security profile from this list to associate with this SSID. If none exist, you can use the Create new Object menu to create one.</p> <p>It is highly recommended that you create security profiles for all of your SSIDs to enhance your network security.</p>
MAC Filtering Profile	<p>Select a MAC filtering profile from the list to associate with this SSID. If none exist, you can use the Create new Object menu to create one.</p> <p>MAC filtering allows you to limit the WiFi clients connecting to your network through a particular SSID by WiFi client MAC addresses. Any clients that have MAC addresses not in the MAC filtering profile of allowed addresses are denied connections.</p> <p>The disable setting means no MAC filtering is used.</p>
Layer-2 Isolation Profile	<p>Select a layer-2 isolation profile from the list to associate with this SSID. If none exist, you can use the Create new Object menu to create one.</p> <p>Layer-2 isolation allows you to prevent WiFi clients associated with your Zyxel Device from communicating with other WiFi clients, APs, computers or routers in a network.</p> <p>The disable setting means no layer-2 isolation is used.</p> <p>This field does not display when you select NAT in Forwarding Mode field.</p>
QoS	<p>Select a Quality of Service (QoS) access category to associate with this SSID. Access categories minimize the delay of data packets across a WiFi network. Certain categories, such as video or voice, are given a higher priority due to the time sensitive nature of their data packets.</p> <p>QoS access categories are as follows:</p> <p>WMM: Enables automatic tagging of data packets. The Zyxel Device assigns access categories to the SSID by examining data as it passes through it and making a best guess effort. If something looks like video traffic, for instance, it is tagged as such.</p> <p>WMM_VOICE: All wireless traffic to the SSID is tagged as voice data. This is recommended if an SSID is used for activities like placing and receiving VoIP phone calls.</p> <p>WMM_VIDEO: All wireless traffic to the SSID is tagged as video data. This is recommended for activities like video conferencing.</p> <p>WMM_BEST_EFFORT: All wireless traffic to the SSID is tagged as "best effort," meaning the data travels the best route it can without displacing higher priority traffic. This is good for activities that do not require the best bandwidth throughput, such as surfing the Internet.</p> <p>WMM_BACKGROUND: All wireless traffic to the SSID is tagged as low priority or "background traffic", meaning all other access categories take precedence over this one. If traffic from an SSID does not have strict throughput requirements, then this access category is recommended. For example, an SSID that only has network printers connected to it.</p>
Rate Limiting (Per Station Traffic Rate)	
Downlink	Define the maximum incoming transmission data rate (either in mbps or kbps) on a per-station basis. The range is from 0–160. Enter 0 to set the maximum rate to unlimited.
Uplink	Define the maximum outgoing transmission data rate (either in mbps or kbps) on a per-station basis. The range is from 0–160. Enter 0 to set the maximum rate to unlimited.
VLAN ID	Enter a VLAN ID for the Zyxel Device to use to tag traffic originating from this SSID. The range is from 1–4094.

Table 65 Configuration > Object > AP Profile > SSID > SSID List > Add or Edit SSID Profile (continued)

LABEL	DESCRIPTION
Hidden SSID	Select this if you want to “hide” your SSID from WiFi clients. This tells any WiFi clients in the vicinity of the AP using this SSID profile not to display its SSID name as a potential connection. Not all WiFi clients respect this flag and display it anyway. When a SSID is “hidden” and a WiFi client cannot see it, the only way you can connect to the SSID is by manually entering the SSID name in your WiFi connection setup screen(s) (these vary by client, client connectivity software, and operating system).
Enable Intra-BSS Traffic Blocking	Select this option to prevent crossover traffic from within the same BSSID on the Zyxel Device.
Enable U-APSD	Select this option to enable Unscheduled Automatic Power Save Delivery (U-APSD), which is also known as WMM-Power Save. This helps increase battery life for battery-powered WiFi clients connected to the Zyxel Device using this SSID profile.
802.11k/v Assisted Roaming	Select this option to enable IEEE 802.11k/v assisted roaming on the Zyxel Device. When the connected clients request 802.11k neighbor lists, the Zyxel Device will response with a list of neighbor APs that can be candidates for roaming.
Schedule SSID	Select this option and set whether the SSID is enabled or disabled on each day of the week. You also need to select the hour and minute (in 24-hour format) to specify the time period of each day during which the SSID is enabled/enabled.
OK	Click OK to save your changes back to the Zyxel Device.
Cancel	Click Cancel to exit this screen without saving your changes.

13.4 Security List

This screen allows you to manage wireless security configurations that can be used by your SSIDs. Wireless security is implemented strictly between the AP broadcasting the SSID and the stations that are connected to it.

MLO in Firmware Version 7.20

To view the introduction of MLO (Multi-Link Operation), please refer to [Multi-Link Operation \(MLO\) on page 181](#).

In firmware version 7.20, MLO is automatically enabled for WiFi networks using the 802.11be radio. However, you cannot use **Open, WEP, WPA1, WPA2, WPA2-Mixed** security settings for any WiFi network using this radio nor hide a WiFi network SSID. In Nebula, you also cannot use **DPPSK** (Dynamic Personal Pre-Shared Key).

Note: If you configure any of these features for a WiFi network (SSID) using the 802.11be radio, then that WiFi network (SSID) will be disabled. You will see a log for this in the event logs. To re-enable the WiFi network (SSID), you must change the security setting to one of **Open, WPA1, WPA2, WPA2-Mixed**, unhide the SSID, and disable **DPPSK** (in Nebula).

To minimize impact on your existing WiFi network configurations, that may be using the above settings, firmware version 7.20 will cause the 2.4 Ghz band to use the 802.11ax radio.

Note: **Open, WEP, WPA1, WPA2, WPA2-Mixed** and **DPPSK** will only work in the 2.4 GHz band. If your WiFi clients in this band do not use these settings, then set the radio mode to 802.11be for full WiFi 7 MLO functionality.

You should use **WPA3**, **WPA3 Transition**, or **Enhanced Open** security for WiFi networks using the 802.11be radio.

Version 7.20 Upgrade Automatic Changes

At the time of writing, upgrading to firmware version 7.20 will make these changes.

Table 66 Security Type in Firmware Version 7.20

EXISTING SECURITY	BAND	CHANGE
Open	2.4 GHz	None (recommend Enhanced Open)
	5 GHz	Enhanced Open
	6 GHz	Enhanced Open
Enhanced Open Transition	2.4 GHz	None (Recommend Enhanced Open unless legacy clients have connectivity issues.)
	5 GHz	Enhanced Open
	6 GHz	Enhanced Open
Enhanced Open	2.4 GHz	None
	5 GHz	None
WEP	2.4 GHz	None (Recommend WPA3 Transition)
	5 GHz	WiFi network (SSID) is disabled.
WPA1	2.4 GHz	None (Recommend WPA3 Transition)
	5 GHz	WiFi network (SSID) is disabled.
WPA2	2.4 GHz	None (Recommend WPA3 Transition)
	5 GHz	WPA3 Transition
WPA2-Mixed	2.4 GHz	None (Recommend WPA3 Transition)
	5 GHz	WiFi network (SSID) is disabled.
	6 GHz	WiFi network (SSID) is disabled.
WPA2-Mixed Enterprise	2.4 GHz	None (Recommend WPA3 Transition)
	5 GHz	WiFi network (SSID) is disabled.
	6 GHz	WiFi network (SSID) is disabled.
WPA2- Enterprise	2.4 GHz	None (Recommend WPA3 Transition)
	5 GHz	WPA3 Enterprise
	6 GHz	WPA3 Enterprise
WPA3- Transition	2.4 GHz	None
	5 GHz	None
	6 GHz	WPA3
WPA3	2.4 GHz	None
	5 GHz	None
	6 GHz	None
WPA3 - Enterprise	2.4 GHz	None
	5 GHz	None
	6 GHz	None

Table 66 Security Type in Firmware Version 7.20 (continued)

EXISTING SECURITY	BAND	CHANGE
DPPSK (in Nebula)	2.4 GHz	None
	5 GHz	WiFi network (SSID) is disabled (Use the 802.11ax radio if you need DPPSK.)
	6 GHz	WiFi network (SSID) is disabled (Use the 802.11ax radio if you need DPPSK.)

To access this screen click **Configuration > Object > AP Profile > SSID > Security List**.

Note: You can have a maximum of 32 security profiles on the Zyxel Device.

Figure 113 Configuration > Object > AP Profile > SSID > Security List

#	Profile Name	Security Mode
1	Wiz_SEC_Profile_1	Open
2	Wiz_SEC_Profile_2	Open
3	Wiz_SEC_Profile_3	Open
4	Wiz_SEC_Profile_4	Open
5	Wiz_SEC_Profile_5	Open
6	Wiz_SEC_Profile_6	Open
7	Wiz_SEC_Profile_7	Open
8	Wiz_SEC_Profile_8	Open
9	default	Open

The following table describes the labels in this screen.

Table 67 Configuration > Object > AP Profile > SSID > Security List

LABEL	DESCRIPTION
Add	Click this to add a new security profile. This button is not available after you configure the Zyxel Device using the wizard.
Edit	Click this to edit the selected security profile.
Remove	Click this to remove the selected security profile. This button is not available after you configure the Zyxel Device using the wizard.
Object Reference	Click this to view which other objects are linked to the selected security profile (for example, SSID profile).
#	This field is a sequential value, and it is not associated with a specific user.
Profile Name	This field indicates the name assigned to the security profile.
Security Mode	This field indicates this profile's security mode (if any).

13.4.1 Add or Edit Security Profile

This screen allows you to create a new security profile or edit an existing one. To access this screen, click the **Add** button or select a security profile from the list and click the **Edit** button.

These screens' options change based on the **Security Mode** selected.

Note: Not all Zyxel Devices support the enterprise authentication settings and radius settings; see [Zyxel Device Product Feature Comparison](#) for more information.

Figure 114 Configuration > Object > AP Profile > SSID > Security List > Add or Edit Security Profile > Security Mode: none

The following table describes the labels in this screen.

Table 68 Configuration > Object > AP Profile > SSID > Security List > Add or Edit Security Profile > Security Mode: none

LABEL	DESCRIPTION
General Settings	
Profile Name	Enter up to 31 alphanumeric characters for the profile name. This name is only visible in the Web Configurator and is only for management purposes. Spaces and underscores are allowed.
Security Mode	Select a security mode from the list: none , enhanced-open , wep , wpa2 , wpa2-mix or wpa3 . enhanced-open uses Opportunistic Wireless Encryption (OWE) which encrypts the wireless connection when possible. Select wpa2-mix if you want the Zyxel Device WiFi network to use WPA2 security mode and provide a fallback WPA security mode for clients that only support WPA connections.
Authentication Settings	
Enterprise	Select this to enable 802.1X secure authentication with a RADIUS server.
ReAuthentication Timer	Enter the interval (in seconds) between authentication requests. Enter a 0 for unlimited time.
Advance	
Note: Click on the Show Advanced Settings button to show the fields describe below.	

Table 68 Configuration > Object > AP Profile > SSID > Security List > Add or Edit Security Profile > Security Mode: none (continued)

LABEL	DESCRIPTION
Idle timeout	Enter the idle interval (in seconds) that a client can be idle before authentication is discontinued.
Radius Settings The Radius Settings fields are only available when you set Authentication Settings to Enterprise .	
Primary / Secondary Radius Server Activate	Select this to have the Zyxel Device use the specified RADIUS server.
Radius Server IP Address	Enter the IP address of the RADIUS server to be used for authentication.
Radius Server Port	Enter the port number of the RADIUS server to be used for authentication.
Radius Server Secret	Enter the shared secret password of the RADIUS server to be used for authentication.
Primary / Secondary Accounting Server Activate	Select the checkbox to enable user accounting through an external authentication server.
Accounting Server IP Address	Enter the IP address of the external accounting server in dotted decimal notation.
Accounting Server Port	Enter the port number of the external accounting server. The default port number is 1813. You need not change this value unless your network administrator instructs you to do so with additional information.
Accounting Share Secret	Enter a password (up to 128 alphanumeric characters) as the key to be shared between the external accounting server and the Zyxel Device. The key must be the same on the external accounting server and your Zyxel Device. The key is not sent over the network.
Accounting Interim Update	This field is available only when you enable user accounting through an external authentication server. Select this to have the Zyxel Device send subscriber status updates to the accounting server at the interval you specify.
Interim Update Interval	Specify the time interval for how often the Zyxel Device is to send a subscriber status update to the accounting server.
General Server Settings	
NAS IP Address	If the RADIUS server requires the Zyxel Device to provide the NAS (Network Access Server) IP address attribute, enter it here.
NAS Identifier	If the RADIUS server requires the Zyxel Device to provide the NAS (Network Access Server) identifier attribute, enter it here. The NAS identifier is to identify the source of access request. It could be the NAS's fully qualified domain name.
OK	Click OK to save your changes back to the Zyxel Device.
Cancel	Click Cancel to exit this screen without saving your changes.

Figure 115 Configuration > Object > AP Profile > SSID > Security List > Add or Edit Security Profile > Security Mode: enhanced-open

Edit Security Profile Zyxel_1

Show Advanced Settings

General Settings

Profile Name:

Security Mode:

Authentication Settings

Transition Mode

Advance

Idle timeout: (30-30000 seconds)

Management Frame Protection Optional Required

OK Cancel

The following table describes the labels in this screen.

Table 69 Configuration > Object > AP Profile > SSID > Security List > Add or Edit Security Profile > Security Mode: enhanced-open

LABEL	DESCRIPTION
General Settings	
Profile Name	Enter up to 31 alphanumeric characters for the profile name. This name is only visible in the Web Configurator and is only for management purposes. Spaces and underscores are allowed.
Security Mode	Select a security mode from the list: none , enhanced-open , wep , wpa2 , wpa2-mix or wpa3 . enhanced-open uses Opportunistic Wireless Encryption (OWE) which encrypts the wireless connection when possible. Select wpa2-mix if you want the Zyxel Device WiFi network to use WPA2 security mode and provide a fallback WPA security mode for clients that only support WPA connections.
Authentication Settings	
Transition Mode	This option only displays if you set the Security Mode to wpa3 or enhanced-open . This option is always enabled for backwards compatibility. This creates two virtual APs (VAPs) with a primary (wpa3 or enhanced-open) and fallback (wpa2 or none) security method.
Advance	
	Note: Click on the Show Advanced Settings button to show the fields described below.
Idle timeout	Enter the idle interval (in seconds) that a client can be idle before authentication is discontinued.

Table 69 Configuration > Object > AP Profile > SSID > Security List > Add or Edit Security Profile > Security Mode: enhanced-open (continued)

LABEL	DESCRIPTION
Management Frame Protection	<p>This field is configurable only when you select wpa2 in the Security Mode field and set Cipher Type to aes.</p> <p>Data frames in 802.11 WLANs can be encrypted and authenticated with WEP, WPA or WPA2. But 802.11 management frames, such as beacon/probe response, association request, association response, de-authentication and disassociation are always unauthenticated and unencrypted. IEEE 802.11w Protected Management Frames allows APs to use the existing security mechanisms (encryption and authentication methods defined in IEEE 802.11i WPA/WPA2) to protect management frames. This helps prevent wireless DoS attacks.</p> <p>Select the checkbox to enable management frame protection (MFP) to add security to 802.11 management frames. This option is always enabled if you select enhanced-open or wpa3 as the Security Mode.</p> <p>If Optional is selected, WiFi clients will not be required to support MFP. Management frames will be encrypted if the clients support MFP.</p> <p>If Required is selected, WiFi clients must support MFP in order to join the Zyxel Device's WiFi network.</p>
OK	Click OK to save your changes back to the Zyxel Device.
Cancel	Click Cancel to exit this screen without saving your changes.

Figure 116 Configuration > Object > AP Profile > SSID > Security List > Add or Edit Security Profile > Security Mode: wep

The following table describes the labels in this screen.

Table 70 Configuration > Object > AP Profile > SSID > Security List > Add or Edit Security Profile > Security Mode: wep

LABEL	DESCRIPTION
General Settings	
Profile Name	Enter up to 31 alphanumeric characters for the profile name. This name is only visible in the Web Configurator and is only for management purposes. Spaces and underscores are allowed.

Table 70 Configuration > Object > AP Profile > SSID > Security List > Add or Edit Security Profile > Security Mode: wep (continued)

LABEL	DESCRIPTION
Security Mode	Select a security mode from the list: none , enhanced-open , wep , wpa2 , wpa2-mix or wpa3 . enhanced-open uses Opportunistic Wireless Encryption (OWE) which encrypts the wireless connection when possible. Select wpa2-mix if you want the Zyxel Device WiFi network to use WPA2 security mode and provide a fallback WPA security mode for clients that only support WPA connections.
Authentication Settings	
Enterprise	Select this to enable 802.1X secure authentication with a RADIUS server.
ReAuthentication Timer	Enter the interval (in seconds) between authentication requests. Enter a 0 for unlimited time.
Authentication Type	Select a WEP authentication method. Choices are Open or Share key.
Key Length	Select the bit-length of the encryption key to be used in WEP connections. If you select WEP-64 : <ul style="list-style-type: none"> Enter 10 hexadecimal digits in the range of "A-F", "a-f" and "0-9" (for example, 0x11AA22BB33) for each Key used. or <ul style="list-style-type: none"> Enter 5 ASCII characters (case sensitive) ranging from "a-z", "A-Z" and "0-9" (for example, MyKey) for each Key used. If you select WEP-128 : <ul style="list-style-type: none"> Enter 26 hexadecimal digits in the range of "A-F", "a-f" and "0-9" (for example, 0x00112233445566778899AABBCC) for each Key used. or <ul style="list-style-type: none"> Enter 13 ASCII characters (case sensitive) ranging from "a-z", "A-Z" and "0-9" (for example, MyKey12345678) for each Key used.
Key 1~4	Based on your Key Length selection, enter the appropriate length hexadecimal or ASCII key.
Advance	
	Note: Click on the Show Advanced Settings button to show the fields describe below.
Idle timeout	Enter the idle interval (in seconds) that a client can be idle before authentication is discontinued.
Radius Settings	
	The Radius Settings fields are only available when you set Authentication Settings to Enterprise .
Primary / Secondary Radius Server Activate	Select this to have the Zyxel Device use the specified RADIUS server.
Radius Server IP Address	Enter the IP address of the RADIUS server to be used for authentication.
Radius Server Port	Enter the port number of the RADIUS server to be used for authentication.
Radius Server Secret	Enter the shared secret password of the RADIUS server to be used for authentication.
Primary / Secondary Accounting Server Activate	Select the checkbox to enable user accounting through an external authentication server.
Accounting Server IP Address	Enter the IP address of the external accounting server in dotted decimal notation.

Table 70 Configuration > Object > AP Profile > SSID > Security List > Add or Edit Security Profile > Security Mode: wep (continued)

LABEL	DESCRIPTION
Accounting Server Port	Enter the port number of the external accounting server. The default port number is 1813. You need not change this value unless your network administrator instructs you to do so with additional information.
Accounting Share Secret	Enter a password (up to 128 alphanumeric characters) as the key to be shared between the external accounting server and the Zyxel Device. The key must be the same on the external accounting server and your Zyxel Device. The key is not sent over the network.
Accounting Interim Update	This field is available only when you enable user accounting through an external authentication server. Select this to have the Zyxel Device send subscriber status updates to the accounting server at the interval you specify.
Interim Update Interval	Specify the time interval for how often the Zyxel Device is to send a subscriber status update to the accounting server.
General Server Settings	
NAS IP Address	If the RADIUS server requires the Zyxel Device to provide the NAS (Network Access Server) IP address attribute, enter it here.
NAS Identifier	If the RADIUS server requires the Zyxel Device to provide the NAS (Network Access Server) identifier attribute, enter it here. The NAS identifier is to identify the source of access request. It could be the NAS's fully qualified domain name.
OK	Click OK to save your changes back to the Zyxel Device.
Cancel	Click Cancel to exit this screen without saving your changes.

Figure 117 Configuration > Object > AP Profile > SSID > Security List > Add or Edit Security Profile> Security Mode: wpa2

The following table describes the labels in this screen.

Table 71 Configuration > Object > AP Profile > SSID > Security List > Add or Edit Security Profile> Security Mode: wpa2

LABEL	DESCRIPTION
General Settings	
Profile Name	Enter up to 31 alphanumeric characters for the profile name. This name is only visible in the Web Configurator and is only for management purposes. Spaces and underscores are allowed.

Table 71 Configuration > Object > AP Profile > SSID > Security List > Add or Edit Security Profile > Security Mode: wpa2 (continued)

LABEL	DESCRIPTION
Security Mode	<p>Select a security mode from the list: none, enhanced-open, wep, wpa2, wpa2-mix or wpa3.</p> <p>enhanced-open uses Opportunistic Wireless Encryption (OWE) which encrypts the wireless connection when possible.</p> <p>Select wpa2-mix if you want the Zyxel Device WiFi network to use WPA2 security mode and provide a fallback WPA security mode for clients that only support WPA connections.</p>
Authentication Settings	
Enterprise	Select this to enable 802.1X secure authentication with a RADIUS server.
ReAuthentication Timer	Enter the interval (in seconds) between authentication requests. Enter a 0 for unlimited time.
Personal	<p>This field is available when you select the wpa2, wpa2-mix or wpa3 security mode.</p> <p>Select this option to use a Pre-Shared Key (PSK) with WPA2 encryption or Simultaneous Authentication of Equals (SAE) with WPA3 encryption.</p>
Pre-Shared Key	Enter a pre-shared key of between 8 and 63 case-sensitive ASCII characters (including spaces and symbols) or 64 hexadecimal characters.
Advance	
Note: Click on the Show Advanced Settings button to show the fields describe below.	
Cipher Type	<p>Select an encryption cipher type from the list.</p> <ul style="list-style-type: none"> • auto - This automatically chooses the best available cipher based on the cipher in use by the WiFi client that is attempting to make a connection. • aes - This is the Advanced Encryption Standard encryption method. It is a more recent development over TKIP and considerably more robust. Not all WiFi clients may support this.
Idle timeout	Enter the idle interval (in seconds) that a client can be idle before authentication is discontinued.
Group Key Update Timer	Enter the interval (in seconds) at which the AP updates the group WPA2 encryption key.
Management Frame Protection	<p>This field is configurable only when you select wpa2 in the Security Mode field and set Cipher Type to aes.</p> <p>Data frames in 802.11 WLANs can be encrypted and authenticated with WEP, WPA or WPA2. But 802.11 management frames, such as beacon/probe response, association request, association response, de-authentication and disassociation are always unauthenticated and unencrypted. IEEE 802.11w Protected Management Frames allows APs to use the existing security mechanisms (encryption and authentication methods defined in IEEE 802.11i WPA/WPA2) to protect management frames. This helps prevent wireless DoS attacks.</p> <p>Select the checkbox to enable management frame protection (MFP) to add security to 802.11 management frames. This option is always enabled if you select enhanced-open or WPA3 as the Security Mode.</p> <p>If Optional is selected, WiFi clients will not be not required to support MFP. Management frames will be encrypted if the clients support MFP.</p> <p>If Required is selected, WiFi clients must support MFP in order to join the Zyxel Device's WiFi network.</p>
Radius Settings	
The Radius Settings fields are only available when you set Authentication Settings to Enterprise .	
Primary / Secondary Radius Server Activate	Select this to have the Zyxel Device use the specified RADIUS server.

Table 71 Configuration > Object > AP Profile > SSID > Security List > Add or Edit Security Profile > Security Mode: wpa2 (continued)

LABEL	DESCRIPTION
Radius Server IP Address	Enter the IP address of the RADIUS server to be used for authentication.
Radius Server Port	Enter the port number of the RADIUS server to be used for authentication.
Radius Server Secret	Enter the shared secret password of the RADIUS server to be used for authentication.
Primary / Secondary Accounting Server Activate	Select the checkbox to enable user accounting through an external authentication server.
Accounting Server IP Address	Enter the IP address of the external accounting server in dotted decimal notation.
Accounting Server Port	Enter the port number of the external accounting server. The default port number is 1813. You need not change this value unless your network administrator instructs you to do so with additional information.
Accounting Share Secret	Enter a password (up to 128 alphanumeric characters) as the key to be shared between the external accounting server and the Zyxel Device. The key must be the same on the external accounting server and your Zyxel Device. The key is not sent over the network.
Accounting Interim Update	This field is available only when you enable user accounting through an external authentication server. Select this to have the Zyxel Device send subscriber status updates to the accounting server at the interval you specify.
Interim Update Interval	Specify the time interval for how often the Zyxel Device is to send a subscriber status update to the accounting server.
General Server Settings	
NAS IP Address	If the RADIUS server requires the Zyxel Device to provide the NAS (Network Access Server) IP address attribute, enter it here.
NAS Identifier	If the RADIUS server requires the Zyxel Device to provide the NAS (Network Access Server) identifier attribute, enter it here. The NAS identifier is to identify the source of access request. It could be the NAS's fully qualified domain name.
OK	Click OK to save your changes back to the Zyxel Device.
Cancel	Click Cancel to exit this screen without saving your changes.

Figure 118 Configuration > Object > AP Profile > SSID > Security List > Add or Edit Security Profile> Security Mode: wpa2-mix

Edit Security Profile Wiz_SEC_Profile_1

Hide Advanced Settings

General Settings

Profile Name:

Security Mode:

Authentication Settings

Enterprise

ReAuthentication Timer: (30~30000 seconds, 0 is unlimited)

Personal

Advance

Cipher Type:

Idle timeout: (30~30000 seconds)

Group Key Update Timer: (30~30000 seconds)

Radius Settings

Primary Radius Server Activate

Radius Server IP Address: ⓘ

Radius Server Port: ⓘ (1~65535)

Radius Server Secret: ⓘ

Secondary Radius Server Activate

Primary Accounting Server Activate

Accounting Server IP Address: ⓘ

Accounting Server Port: ⓘ (1~65535)

Accounting Share Secret: ⓘ

Secondary Accounting Server Activate

Accounting Interim Update

Interim Update Interval: (1~1440 minutes)

General Server Settings

NAS IP Address: (Optional)

NAS Identifier: (Optional)

The following table describes the labels in this screen.

Table 72 Configuration > Object > AP Profile > SSID > Security List > Add or Edit Security Profile> Security Mode: wpa2-mix

LABEL	DESCRIPTION
General Settings	
Profile Name	Enter up to 31 alphanumeric characters for the profile name. This name is only visible in the Web Configurator and is only for management purposes. Spaces and underscores are allowed.

Table 72 Configuration > Object > AP Profile > SSID > Security List > Add or Edit Security Profile > Security Mode: wpa2-mix (continued)

LABEL	DESCRIPTION
Security Mode	Select a security mode from the list: none , enhanced-open , wep , wpa2 , wpa2-mix or wpa3 . enhanced-open uses Opportunistic Wireless Encryption (OWE) which encrypts the wireless connection when possible. Select wpa2-mix if you want the Zyxel Device WiFi network to use WPA2 security mode and provide a fallback WPA security mode for clients that only support WPA connections.
Authentication Settings	
Enterprise	Select this to enable 802.1X secure authentication with a RADIUS server.
ReAuthentication Timer	Enter the interval (in seconds) between authentication requests. Enter a 0 for unlimited time.
Personal	This field is available when you select the wpa2 , wpa2-mix or wpa3 security mode. Select this option to use a Pre-Shared Key (PSK) with WPA2 encryption or Simultaneous Authentication of Equals (SAE) with WPA3 encryption.
Pre-Shared Key	Enter a pre-shared key of between 8 and 63 case-sensitive ASCII characters (including spaces and symbols) or 64 hexadecimal characters.
Advance	
Note: Click on the Show Advanced Settings button to show the fields describe below.	
Cipher Type	Select an encryption cipher type from the list. <ul style="list-style-type: none"> auto - This automatically chooses the best available cipher based on the cipher in use by the WiFi client that is attempting to make a connection. aes - This is the Advanced Encryption Standard encryption method. It is a more recent development over TKIP and considerably more robust. Not all WiFi clients may support this.
Idle timeout	Enter the idle interval (in seconds) that a client can be idle before authentication is discontinued.
Group Key Update Timer	Enter the interval (in seconds) at which the AP updates the group WPA2 encryption key.
Radius Settings	
The Radius Settings fields are only available when you set Authentication Settings to Enterprise .	
Primary / Secondary Radius Server Activate	Select this to have the Zyxel Device use the specified RADIUS server.
Radius Server IP Address	Enter the IP address of the RADIUS server to be used for authentication.
Radius Server Port	Enter the port number of the RADIUS server to be used for authentication.
Radius Server Secret	Enter the shared secret password of the RADIUS server to be used for authentication.
Primary / Secondary Accounting Server Activate	Select the checkbox to enable user accounting through an external authentication server.
Accounting Server IP Address	Enter the IP address of the external accounting server in dotted decimal notation.
Accounting Server Port	Enter the port number of the external accounting server. The default port number is 1813. You need not change this value unless your network administrator instructs you to do so with additional information.
Accounting Share Secret	Enter a password (up to 128 alphanumeric characters) as the key to be shared between the external accounting server and the Zyxel Device. The key must be the same on the external accounting server and your Zyxel Device. The key is not sent over the network.

Table 72 Configuration > Object > AP Profile > SSID > Security List > Add or Edit Security Profile> Security Mode: wpa2-mix (continued)

LABEL	DESCRIPTION
Accounting Interim Update	This field is available only when you enable user accounting through an external authentication server. Select this to have the Zyxel Device send subscriber status updates to the accounting server at the interval you specify.
Interim Update Interval	Specify the time interval for how often the Zyxel Device is to send a subscriber status update to the accounting server.
General Server Settings	
NAS IP Address	If the RADIUS server requires the Zyxel Device to provide the NAS (Network Access Server) IP address attribute, enter it here.
NAS Identifier	If the RADIUS server requires the Zyxel Device to provide the NAS (Network Access Server) identifier attribute, enter it here. The NAS identifier is to identify the source of access request. It could be the NAS's fully qualified domain name.
OK	Click OK to save your changes back to the Zyxel Device.
Cancel	Click Cancel to exit this screen without saving your changes.

Figure 119 Configuration > Object > AP Profile > SSID > Security List > Add or Edit Security Profile> Security Mode: wpa3-personal

Edit Security Profile Zyxel_1

Show Advanced Settings

General Settings

Profile Name: Zyxel_1

Security Mode: wpa3

Authentication Settings

Personal

Pre-Shared Key: !

Transition Mode

Advance

Idle timeout: 300 (30-30000 seconds)

Group Key Update Timer: 30000 (30-30000 seconds)

Management Frame Protection Optional Required

OK Cancel

Figure 120 Configuration > Object > AP Profile > SSID > Security List > Add or Edit Security Profile > Security Mode: wpa3-enterprise

Edit Security Profile Wiz_SEC_Profile_1

Hide Advanced Settings

General Settings

Profile Name:

Security Mode:

Authentication Settings

Enterprise

ReAuthentication Timer: (30~30000 seconds, 0 is unlimited)

Personal

Advance

Idle timeout: (30-30000 seconds)

Group Key Update Timer: (30-30000 seconds)

Management Frame Protection Optional Required

Radius Settings

Primary Radius Server Activate

Radius Server IP Address: ⓘ

Radius Server Port: ⓘ (1~65535)

Radius Server Secret: ⓘ

Secondary Radius Server Activate

Primary Accounting Server Activate

Accounting Server IP Address: ⓘ

Accounting Server Port: ⓘ (1~65535)

Accounting Share Secret: ⓘ

Secondary Accounting Server Activate

Accounting Interim Update

Interim Update Interval: (1-1440 minutes)

General Server Settings

NAS IP Address: (Optional)

NAS Identifier: (Optional)

OK Cancel

The following table describes the labels in this screen.

Table 73 Configuration > Object > AP Profile > SSID > Security List > Add or Edit Security Profile > Security Mode: wpa3

LABEL	DESCRIPTION
General Settings	
Profile Name	Enter up to 31 alphanumeric characters for the profile name. This name is only visible in the Web Configurator and is only for management purposes. Spaces and underscores are allowed.

Table 73 Configuration > Object > AP Profile > SSID > Security List > Add or Edit Security Profile > Security Mode: wpa3 (continued)

LABEL	DESCRIPTION
Security Mode	<p>Select a security mode from the list: none, enhanced-open, wep, wpa2, wpa2-mix or wpa3.</p> <p>enhanced-open uses Opportunistic Wireless Encryption (OWE) which encrypts the wireless connection when possible.</p> <p>Select wpa2-mix if you want the Zyxel Device WiFi network to use WPA2 security mode and provide a fallback WPA security mode for clients that only support WPA connections.</p>
Authentication Settings	
Enterprise	Select this to enable 802.1X secure authentication with a RADIUS server.
ReAuthentication Timer	Enter the interval (in seconds) between authentication requests. Enter a 0 for unlimited time.
Personal	<p>This field is available when you select the wpa2, wpa2-mix or wpa3 security mode.</p> <p>Select this option to use a Pre-Shared Key (PSK) with WPA2 encryption or Simultaneous Authentication of Equals (SAE) with WPA3 encryption.</p>
Pre-Shared Key	Enter a pre-shared key of between 8 and 63 case-sensitive ASCII characters (including spaces and symbols) or 64 hexadecimal characters.
Transition Mode	<p>This option only displays if you set the Security Mode to wpa3 or enhanced-open. This option is always enabled for backwards compatibility.</p> <p>This creates two virtual APs (VAPs) with a primary (wpa3 or enhanced-open) and fallback (wpa2 or none) security method.</p> <p>If you want to set the security mode to WPA3-only, use the CLI to disable Transition Mode. See the CLI Reference Guide for more information.</p>
Advance	
Note: Click on the Show Advanced Settings button to show the fields describe below.	
Idle Timeout	Enter the idle interval (in seconds) that a client can be idle before authentication is discontinued.
Group Key Update Timer	Enter the interval (in seconds) at which the AP updates the group WPA2 encryption key.
Management Frame Protection	<p>This field is configurable only when you select wpa2 in the Security Mode field and set Cipher Type to aes.</p> <p>Data frames in 802.11 WLANs can be encrypted and authenticated with WEP, WPA or WPA2. But 802.11 management frames, such as beacon/probe response, association request, association response, de-authentication and disassociation are always unauthenticated and unencrypted. IEEE 802.11w Protected Management Frames allows APs to use the existing security mechanisms (encryption and authentication methods defined in IEEE 802.11i WPA/WPA2) to protect management frames. This helps prevent wireless DoS attacks.</p> <p>Select the checkbox to enable management frame protection (MFP) to add security to 802.11 management frames. This option is always enabled if you select enhanced-open or WPA3 as the Security Mode.</p> <p>If Optional is selected, WiFi clients will not be not required to support MFP. Management frames will be encrypted if the clients support MFP.</p> <p>If Required is selected, WiFi clients must support MFP in order to join the Zyxel Device's WiFi network.</p>
Radius Settings	
The Radius Settings fields are only available when you set Authentication Settings to Enterprise .	
Primary / Secondary Radius Server Activate	Select this to have the Zyxel Device use the specified RADIUS server.

Table 73 Configuration > Object > AP Profile > SSID > Security List > Add or Edit Security Profile > Security Mode: wpa3 (continued)

LABEL	DESCRIPTION
Radius Server IP Address	Enter the IP address of the RADIUS server to be used for authentication.
Radius Server Port	Enter the port number of the RADIUS server to be used for authentication.
Radius Server Secret	Enter the shared secret password of the RADIUS server to be used for authentication.
Primary / Secondary Accounting Server Activate	Select the checkbox to enable user accounting through an external authentication server.
Accounting Server IP Address	Enter the IP address of the external accounting server in dotted decimal notation.
Accounting Server Port	Enter the port number of the external accounting server. The default port number is 1813. You need not change this value unless your network administrator instructs you to do so with additional information.
Accounting Share Secret	Enter a password (up to 128 alphanumeric characters) as the key to be shared between the external accounting server and the Zyxel Device. The key must be the same on the external accounting server and your Zyxel Device. The key is not sent over the network.
Accounting Interim Update	This field is available only when you enable user accounting through an external authentication server. Select this to have the Zyxel Device send subscriber status updates to the accounting server at the interval you specify.
Interim Update Interval	Specify the time interval for how often the Zyxel Device is to send a subscriber status update to the accounting server.
General Server Settings	
NAS IP Address	If the RADIUS server requires the Zyxel Device to provide the NAS (Network Access Server) IP address attribute, enter it here.
NAS Identifier	If the RADIUS server requires the Zyxel Device to provide the NAS (Network Access Server) identifier attribute, enter it here. The NAS identifier is to identify the source of access request. It could be the NAS's fully qualified domain name.
OK	Click OK to save your changes back to the Zyxel Device.
Cancel	Click Cancel to exit this screen without saving your changes.

13.4.2 Creating a Security Profile

The following example shows you how to create a security profile using the parameters given in the below table.

Table 74 Security Profile Settings

	SECURITY PROFILE
Profile Name	Security_Profile1
Security Mode	WPA3
Authentication	Personal
Pre-Shared Key	zyxel1234

- 1 Go to **Configuration > Object > AP Profile > SSID > Security List**. Click **Add** to create a new security profile on the Zyxel Device.

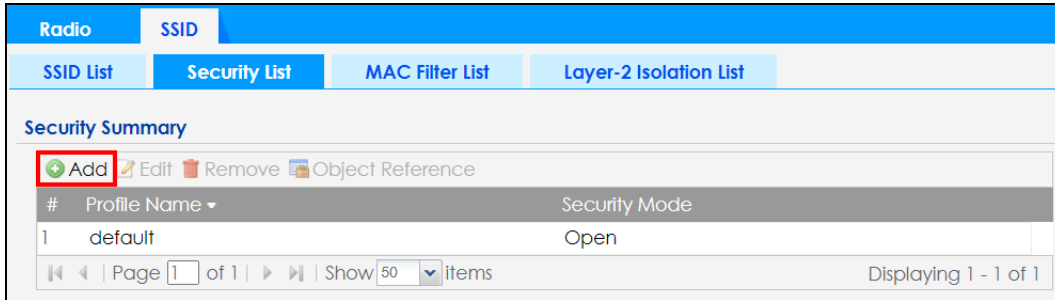

- 2 Use the parameters given above and keep other configurations at their default values. Click **OK**.

Add Security Profile

Show Advanced Settings

General Settings

Profile Name: Security_Profile1

Security Mode: wpa3

Authentication Settings

Enterprise

Personal

Pre-Shared Key:

Transition Mode

Advance

Idle timeout: 300 (30-30000 seconds)

Group Key Update Timer: 30000 (30-30000 seconds)

Management Frame Protection Optional Required

OK **Cancel**

- 3 You will then see the **Security_Profile1** entry in the summary table.

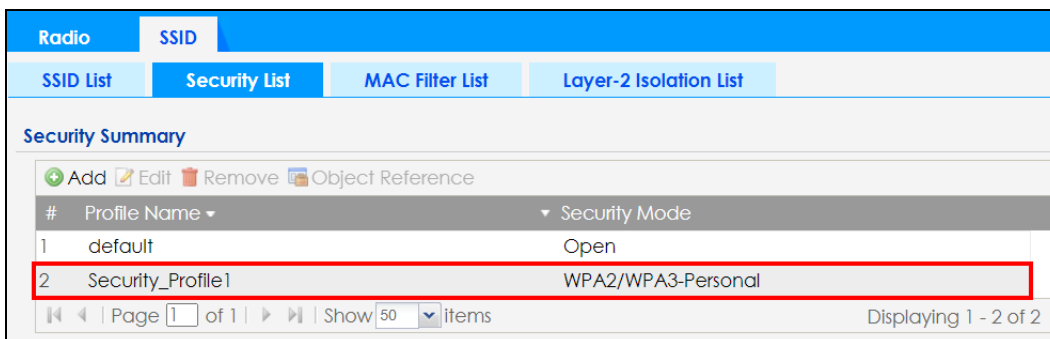

13.5 MAC Filter List

This screen allows you to create and manage security configurations that can be used by your SSIDs. To access this screen click **Configuration > Object > AP Profile > SSID > MAC Filter List**.

Note: You can have a maximum of 32 MAC filtering profiles on the Zyxel Device.

Figure 121 Configuration > Object > AP Profile > SSID > MAC Filter List

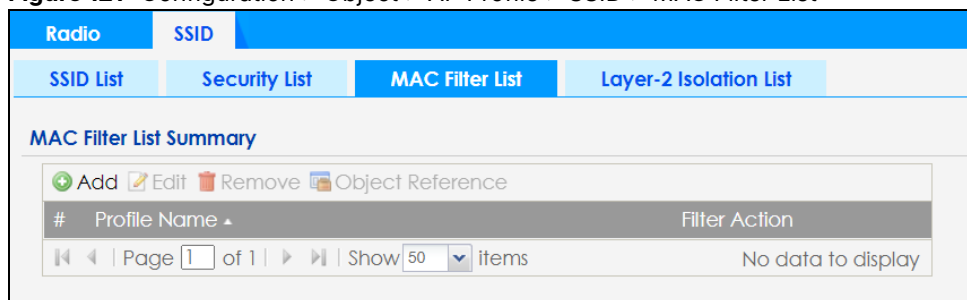

The following table describes the labels in this screen.

Table 75 Configuration > Object > AP Profile > SSID > MAC Filter List

LABEL	DESCRIPTION
Add	Click this to add a new MAC filtering profile.
Edit	Click this to edit the selected MAC filtering profile.
Remove	Click this to remove the selected MAC filtering profile.
Object Reference	Click this to view which other objects are linked to the selected MAC filtering profile (for example, SSID profile).
#	This field is a sequential value, and it is not associated with a specific user.
Profile Name	This field indicates the name assigned to the MAC filtering profile.
Filter Action	This field indicates this profile's filter action (if any).

13.5.1 Add or Edit MAC Filter Profile

This screen allows you to create a new MAC filtering profile or edit an existing one. To access this screen, click the **Add** button or select a MAC filter profile from the list and click the **Edit** button.

Note: Each MAC filtering profile can include a maximum of 512 MAC addresses.

Figure 122 Configuration > Object > AP Profile > SSID > MAC Filter List > Add or Edit MAC Filter Profile

The following table describes the labels in this screen.

Table 76 Configuration > Object > AP Profile > SSID > MAC Filter List > Add or Edit MAC Filter Profile

LABEL	DESCRIPTION
Profile Name	Enter up to 31 alphanumeric characters for the profile name. This name is only visible in the Web Configurator and is only for management purposes. Spaces and underscores are allowed.
Filter Action	Select allow to permit the WiFi client with the MAC addresses in this profile to connect to the network through the associated SSID; select deny to block the WiFi clients with the specified MAC addresses.
Add	Click this to add a MAC address to the profile's list.
Edit	Click this to edit the selected MAC address in the profile's list.
Remove	Click this to remove the selected MAC address from the profile's list.
#	This field is a sequential value, and it is not associated with a specific user.
MAC	This field specifies a MAC address associated with this profile. You can click the MAC address to make it editable.
Description	This field displays a description for the MAC address associated with this profile. You can click the description to make it editable. Enter up to 60 characters, spaces and underscores allowed.
OK	Click OK to save your changes back to the Zyxel Device.
Cancel	Click Cancel to exit this screen without saving your changes.

13.6 Layer-2 Isolation List

Layer-2 isolation is used to prevent WiFi clients associated with your Zyxel Device from communicating with other WiFi clients, APs, computers or routers in a network.

In the following example, layer-2 isolation is enabled on the Zyxel Device to allow a guest WiFi client (**A**) to access the main network router (**B**). The router provides access to the Internet and the network printer (**C**) while preventing the client from accessing other computers and servers on the network. The client can communicate with other WiFi clients only if Intra-BSS Traffic blocking is disabled.

Note: Not all models support the layer-2 isolation feature. See the feature comparison table in [Zyxel Device Product Feature Comparison](#).

Note: Intra-BSS Traffic Blocking is activated when you enable layer-2 isolation.

Figure 123 Layer-2 Isolation Application

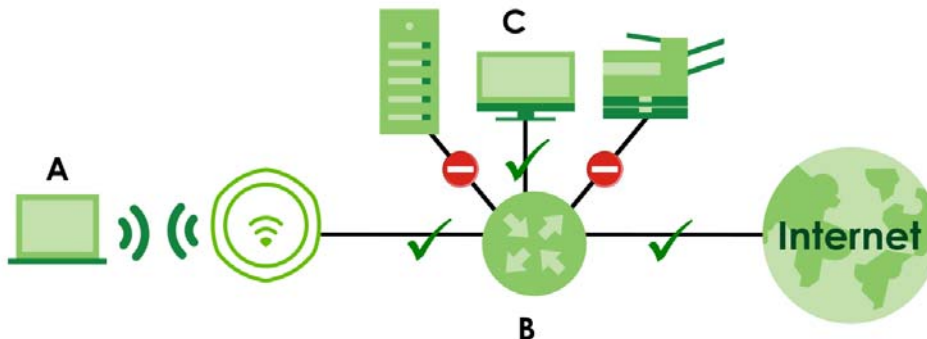

MAC addresses that are not listed in the layer-2 isolation table are blocked from communicating with the Zyxel Device's WiFi clients except for broadcast packets. Layer-2 isolation does not check the traffic between WiFi clients that are associated with the same AP. Intra-BSS traffic allows WiFi clients associated with the same AP to communicate with each other.

This screen allows you to specify devices you want the users on your WiFi networks to access. To access this screen click **Configuration > Object > AP Profile > SSID > Layer-2 Isolation List**.

Figure 124 Configuration > Object > AP Profile > SSID > Layer-2 Isolation List

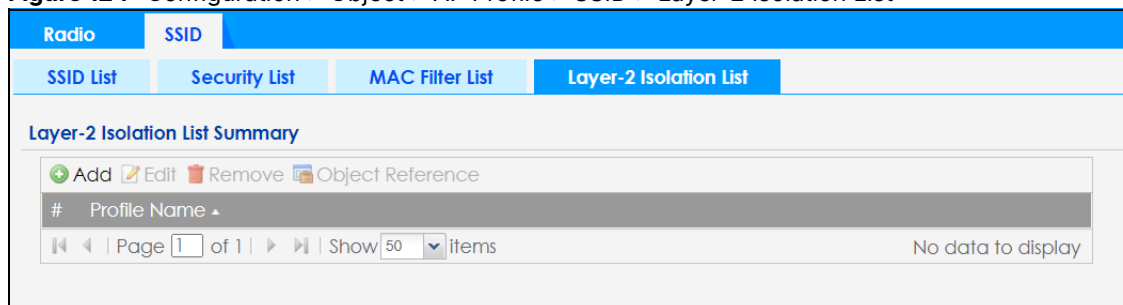

The following table describes the labels in this screen.

Table 77 Configuration > Object > AP Profile > SSID > Layer-2 Isolation List

LABEL	DESCRIPTION
Add	Click this to add a new layer-2 isolation profile.
Edit	Click this to edit the selected layer-2 isolation profile.
Remove	Click this to remove the selected layer-2 isolation profile.
Object Reference	Click this to view which other objects are linked to the selected layer-2 isolation profile (for example, SSID profile).
#	This field is a sequential value, and it is not associated with a specific user.
Profile Name	This field indicates the name assigned to the layer-2 isolation profile.

13.6.1 Add or Edit Layer-2 Isolation Profile

This screen allows you to create a new layer-2 isolation profile or edit an existing one. To access this screen, click the **Add** button or select a layer-2 isolation profile from the list and click the **Edit** button.

Note: You need to know the MAC address of each WiFi client, AP, computer or router that you want to allow to communicate with the Zyxel Device's WiFi clients.

Figure 125 Configuration > Object > AP Profile > SSID > Layer-2 Isolation List > Add or Edit Layer-2 Isolation Profile

The following table describes the labels in this screen.

Table 78 Configuration > Object > AP Profile > SSID > Layer-2 Isolation List > Add or Edit Layer-2 Isolation Profile

LABEL	DESCRIPTION
Profile Name	Enter up to 31 alphanumeric characters for the profile name. This name is only visible in the Web Configurator and is only for management purposes. Spaces and underscores are allowed.
Add	Click this to add a MAC address to the profile's list.
Edit	Click this to edit the selected MAC address in the profile's list.
Remove	Click this to remove the selected MAC address from the profile's list.
#	This field is a sequential value, and it is not associated with a specific user.
MAC	This field specifies a MAC address associated with this profile. You can click the MAC address to make it editable.
Description	This field displays a description for the MAC address associated with this profile. You can click the description to make it editable. Enter up to 60 characters, spaces and underscores allowed.
OK	Click OK to save your changes back to the Zyxel Device.
Cancel	Click Cancel to exit this screen without saving your changes.

CHAPTER 14

WDS Profile

14.1 Overview

This chapter shows you how to configure WDS (Wireless Distribution System) profiles for the Zyxel Device to form a WDS with other APs.

14.1.1 What You Can Do in this Chapter

The **WDS Profile** screen ([WDS Profile](#)) creates preset WDS configurations that can be used by the Zyxel Device.

14.2 WDS Profile

This screen allows you to manage and create WDS profiles that can be used by the APs. To access this screen, click **Configuration > Object > WDS Profile**.

Figure 126 Configuration > Object > WDS Profile

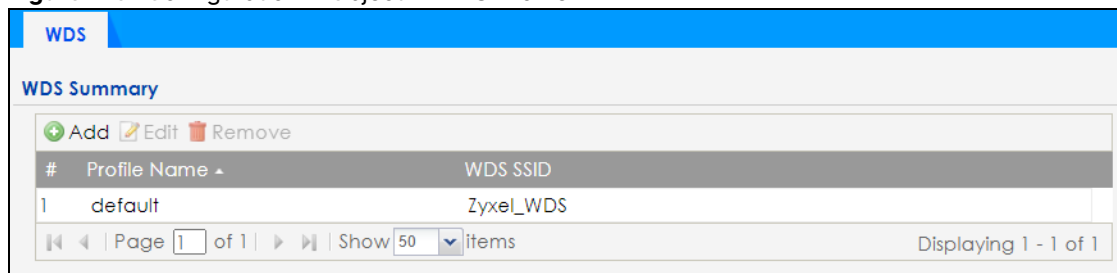

The following table describes the labels in this screen.

Table 79 Configuration > Object > WDS Profile

LABEL	DESCRIPTION
Add	Click this to add a new profile.
Edit	Click this to edit the selected profile.
Remove	Click this to remove the selected profile.
#	This field is a sequential value, and it is not associated with a specific profile.
Profile Name	This field indicates the name assigned to the profile.
WDS SSID	This field shows the SSID specified in this WDS profile.

14.2.1 Add or Edit WDS Profile

This screen allows you to create a new WDS profile or edit an existing one. To access this screen, click the **Add** button or select an existing profile and click the **Edit** button.

Figure 127 Configuration > Object > WDS Profile > Add or Edit WDS Profile

The following table describes the labels in this screen.

Table 80 Configuration > Object > WDS Profile > Add or Edit WDS Profile

LABEL	DESCRIPTION
Profile Name	Enter up to 31 alphanumeric characters for the profile name.
WDS SSID	Enter the SSID with which you want the Zyxel Device to connect to a root AP or repeater to form a WDS.
Pre-Shared Key	Enter a pre-shared key of between 8 and 63 case-sensitive ASCII characters (including spaces and symbols) or 64 hexadecimal characters. The key is used to encrypt the traffic between the APs.
OK	Click OK to save your changes back to the Zyxel Device.
Cancel	Click Cancel to exit this screen without saving your changes.

CHAPTER 15

Certificates

15.1 Overview

The Zyxel Device can use certificates (also called digital IDs) to authenticate users. Certificates are based on public-private key pairs. A certificate contains the certificate owner's identity and public key. Certificates provide a way to exchange public keys for use in authentication.

15.1.1 What You Can Do in this Chapter

- The **My Certificates** screens ([My Certificates](#)) generate and export self-signed certificates or certification requests and import the Zyxel Device's CA-signed certificates.
- The **Trusted Certificates** screens ([Trusted Certificates](#)) save CA certificates and trusted remote host certificates to the Zyxel Device. The Zyxel Device trusts any valid certificate that you have imported as a trusted certificate. It also trusts any valid certificate signed by any of the certificates that you have imported as a trusted certificate.

15.1.2 What You Need to Know

The following terms and concepts may help as you read this chapter.

When using public-key cryptology for authentication, each host has two keys. One key is public and can be made openly available. The other key is private and must be kept secure.

These keys work like a handwritten signature (in fact, certificates are often referred to as "digital signatures"). Only you can write your signature exactly as it should look. When people know what your signature looks like, they can verify whether something was signed by you, or by someone else. In the same way, your private key "writes" your digital signature and your public key allows people to verify whether data was signed by you, or by someone else.

This process works as follows:

- 1 Tim wants to send a message to Jenny. He needs her to be sure that it comes from him, and that the message content has not been altered by anyone else along the way. Tim generates a public key pair (one public key and one private key).
- 2 Tim keeps the private key and makes the public key openly available. This means that anyone who receives a message seeming to come from Tim can read it and verify whether it is really from him or not.
- 3 Tim uses his private key to sign the message and sends it to Jenny.
- 4 Jenny receives the message and uses Tim's public key to verify it. Jenny knows that the message is from Tim, and that although other people may have been able to read the message, no-one can have altered it (because they cannot re-sign the message with Tim's private key).

- 5 Additionally, Jenny uses her own private key to sign a message and Tim uses Jenny's public key to verify the message.

The Zyxel Device uses certificates based on public-key cryptology to authenticate users attempting to establish a connection, not to encrypt the data that you send after establishing a connection. The method used to secure the data that you send through an established connection depends on the type of connection.

The certification authority uses its private key to sign certificates. Anyone can then use the certification authority's public key to verify the certificates.

A certification path is the hierarchy of certification authority certificates that validate a certificate. The Zyxel Device does not trust a certificate if any certificate on its path has expired or been revoked.

Certification authorities maintain directory servers with databases of valid and revoked certificates. A directory of certificates that have been revoked before the scheduled expiration is called a CRL (Certificate Revocation List). The Zyxel Device can check a peer's certificate against a directory server's list of revoked certificates. The framework of servers, software, procedures and policies that handles keys is called PKI (public-key infrastructure).

Advantages of Certificates

Certificates offer the following benefits.

- The Zyxel Device only has to store the certificates of the certification authorities that you decide to trust, no matter how many devices you need to authenticate.
- Key distribution is simple and very secure since you can freely distribute public keys and you never need to transmit private keys.

Self-signed Certificates

You can have the Zyxel Device act as a certification authority and sign its own certificates.

Factory Default Certificate

The Zyxel Device generates its own unique self-signed certificate when you first turn it on. This certificate is referred to in the GUI as the factory default certificate.

Certificate File Formats

Any certificate that you want to import has to be in one of these file formats:

- Binary X.509: This is an ITU-T recommendation that defines the formats for X.509 certificates.
- PEM (Base-64) encoded X.509: This Privacy Enhanced Mail format uses lowercase letters, uppercase letters and numerals to convert a binary X.509 certificate into a printable form.
- Binary PKCS#7: This is a standard that defines the general syntax for data (including digital signatures) that may be encrypted. A PKCS #7 file is used to transfer a public key certificate. The private key is not included. The Zyxel Device currently allows the importation of a PKS#7 file that contains a single certificate.
- PEM (Base-64) encoded PKCS#7: This Privacy Enhanced Mail (PEM) format uses lowercase letters, uppercase letters and numerals to convert a binary PKCS#7 certificate into a printable form.

- Binary PKCS#12: This is a format for transferring public key and private key certificates. The private key in a PKCS #12 file is within a password-encrypted envelope. The file's password is not connected to your certificate's public or private passwords. Exporting a PKCS #12 file creates this and you must provide it to decrypt the contents when you import the file into the Zyxel Device.

Note: Be careful not to convert a binary file to text during the transfer process. It is easy for this to occur since many programs use text files by default.

15.1.3 Verifying a Certificate

Before you import a trusted certificate into the Zyxel Device, you should verify that you have the correct certificate. You can do this using the certificate's fingerprint. A certificate's fingerprint is a message digest calculated using the MD5 or SHA1 algorithm. The following procedure describes how to check a certificate's fingerprint to verify that you have the actual certificate.

- 1 Browse to where you have the certificate saved on your computer.
- 2 Make sure that the certificate has a ".cer" or ".crt" file name extension.

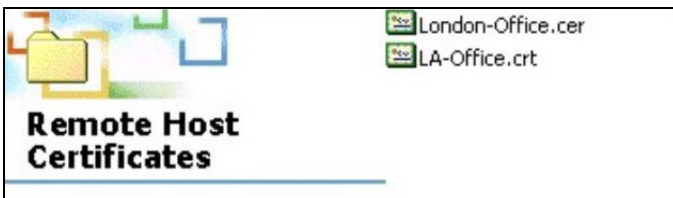

- 3 Double-click the certificate's icon to open the **Certificate** window. Click the **Details** tab and scroll down to the **Thumbprint Algorithm** and **Thumbprint** fields.

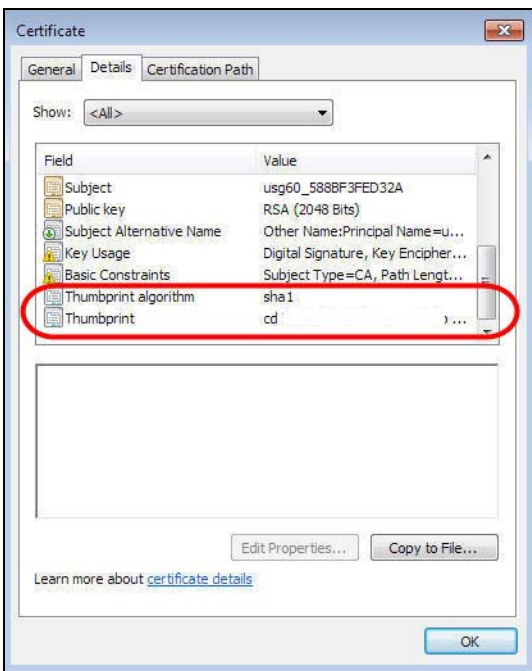

- 4 Use a secure method to verify that the certificate owner has the same information in the **Thumbprint Algorithm** and **Thumbprint** fields. The secure method may vary based on your situation. Possible examples would be over the telephone or through an HTTPS connection.

15.2 My Certificates

Click **Configuration > Object > Certificate > My Certificates** to open this screen. This is the Zyxel Device's summary list of certificates and certification requests.

Figure 128 Configuration > Object > Certificate > My Certificates

The following table describes the labels in this screen.

Table 81 Configuration > Object > Certificate > My Certificates

LABEL	DESCRIPTION
PKI Storage Space in Use	This bar displays the percentage of the Zyxel Device's PKI storage space that is currently in use. When the storage space is almost full, you should consider deleting expired or unnecessary certificates before adding more certificates.
My Certificates Settings	
Add	Click this to go to the screen where you can have the Zyxel Device generate a certificate or a certification request.
Edit	Double-click an entry or select it and click Edit to open a screen with an in-depth list of information about the certificate.
Remove	The Zyxel Device keeps all of your certificates unless you specifically delete them. Uploading a new firmware or default configuration file does not delete your certificates. To remove an entry, select it and click Remove . The Zyxel Device confirms you want to remove it before doing so. Subsequent certificates move up by one when you take this action.
Object Reference	You cannot delete certificates that any of the Zyxel Device's features are configured to use. Select an entry and click Object Reference to open a screen that shows which settings use the entry.
#	This field displays the certificate index number. The certificates are listed in alphabetical order.
Name	This field displays the name used to identify this certificate. It is recommended that you give each certificate a unique name.
Type	This field displays what kind of certificate this is. REQ represents a certification request and is not yet a valid certificate. Send a certification request to a certification authority, which then issues a certificate. Use the My Certificate Import screen to import the certificate and replace the request. SELF represents a self-signed certificate. CERT represents a certificate issued by a certification authority.
Subject	This field displays identifying information about the certificate's owner, such as CN (Common Name), OU (Organizational Unit or department), O (Organization or company) and C (Country). It is recommended that each certificate have unique subject information.

Table 81 Configuration > Object > Certificate > My Certificates (continued)

LABEL	DESCRIPTION
Issuer	This field displays identifying information about the certificate's issuing certification authority, such as a common name, organizational unit or department, organization or company and country. With self-signed certificates, this is the same information as in the Subject field.
Valid From	This field displays the date that the certificate becomes applicable.
Valid To	This field displays the date that the certificate expires. The text displays in red and includes an Expired! message if the certificate has expired.
Import	Click Import to open a screen where you can save a certificate to the Zyxel Device.
Refresh	Click Refresh to display the current validity status of the certificates.

15.2.1 Add My Certificates

Click **Configuration > Object > Certificate > My Certificates** and then the **Add** icon to open the **Add My Certificates** screen. Use this screen to have the Zyxel Device create a self-signed certificate, enroll a certificate with a certification authority or generate a certification request.

Figure 129 Configuration > Object > Certificate > My Certificates > Add

Add My Certificates

Configuration

Name:

Subject Information

Host IP Address
 Host Domain Name
 E-Mail
 Organizational Unit: (Optional)
 Organization: (Optional)
 Town(City): (Optional)
 State(Province): (Optional)
 Country: (Optional)

Key Type: RSA-SHA256
 Key Length: 2048 bits

Extended Key Usage

Server Authentication
 Client Authentication

Create a self-signed certificate
 Create a certification request and save it locally for later manual enrollment

OK Cancel

The following table describes the labels in this screen.

Table 82 Configuration > Object > Certificate > My Certificates > Add

LABEL	DESCRIPTION
Name	Type a name to identify this certificate. You can use up to 31 alphanumeric and ;'~!@#\$\$%^&()_+[]{}',.- characters.
Subject Information	<p>Use these fields to record information that identifies the owner of the certificate. You do not have to fill in every field, although you must specify a Host IP Address, Host Domain Name, or E-Mail. The certification authority may add fields (such as a serial number) to the subject information when it issues a certificate. It is recommended that each certificate have unique subject information.</p> <p>Select a radio button to identify the certificate's owner by IP address, domain name or email address. Type the IP address (in dotted decimal notation), domain name or email address in the field provided. The domain name or email address is for identification purposes only and can be any string.</p> <p>A domain name can be up to 255 characters. You can use alphanumeric characters, the hyphen and periods.</p> <p>An email address can be up to 63 characters. You can use alphanumeric characters, the hyphen, the @ symbol, periods and the underscore.</p>
Organizational Unit	Identify the organizational unit or department to which the certificate owner belongs. You can use up to 31 characters. You can use alphanumeric characters, the hyphen and the underscore.
Organization	Identify the company or group to which the certificate owner belongs. You can use up to 31 characters. You can use alphanumeric characters, the hyphen and the underscore.
Town (City)	Identify the town or city where the certificate owner is located. You can use up to 31 characters. You can use alphanumeric characters, the hyphen and the underscore.
State (Province)	Identify the state or province where the certificate owner is located. You can use up to 31 characters. You can use alphanumeric characters, the hyphen and the underscore.
Country	Identify the nation where the certificate owner is located. You can use up to 31 characters. You can use alphanumeric characters, the hyphen and the underscore.
Key Type	<p>The Zyxel Device uses the RSA (Rivest, Shamir and Adleman) public-key encryption algorithm. SHA1 (Secure Hash Algorithm) and SHA2 are hash algorithms used to authenticate packet data. SHA2-256 or SHA2-512 are part of the SHA2 set of cryptographic functions and they are considered even more secure than SHA1.</p> <p>Select a key type from RSA-SHA256 and RSA-SHA512.</p>
Key Length	Select a number from the drop-down list box to determine how many bits the key should use (1024 to 2048). The longer the key, the more secure it is. A longer key also uses more PKI storage space.
Extended Key Usage	<p>Select Server Authentication to allow a web server to send clients the certificate to authenticate itself.</p> <p>Select Client Authentication to use the certificate's key to authenticate clients to the secure gateway.</p>
Use the below radio buttons to set how and when the certificate is to be generated.	
Create a self-signed certificate	Select this to have the Zyxel Device generate the certificate and act as the Certification Authority (CA) itself. This way you do not need to apply to a certification authority for certificates.
Create a certification request and save it locally for later manual enrollment	<p>Select this to have the Zyxel Device generate and store a request for a certificate. Use the My Certificate Edit screen to view the certification request and copy it to send to the certification authority.</p> <p>Copy the certification request from the My Certificate Edit screen and then send it to the certification authority.</p>

Table 82 Configuration > Object > Certificate > My Certificates > Add (continued)

LABEL	DESCRIPTION
OK	Click OK to begin certificate or certification request generation.
Cancel	Click Cancel to quit and return to the My Certificates screen.

If you configured the **Add My Certificates** screen to have the Zyxel Device enroll a certificate and the certificate enrollment is not successful, you see a screen with a **Return** button that takes you back to the **Add My Certificates** screen. Click **Return** and check your information in the **Add My Certificates** screen. Make sure that the certification authority information is correct and that your Internet connection is working properly if you want the Zyxel Device to enroll a certificate online.

15.2.2 Edit My Certificates

Click **Configuration > Object > Certificate > My Certificates** and then the **Edit** icon to open the **My Certificate Edit** screen. You can use this screen to view in-depth certificate information and change the certificate's name.

Figure 130 Configuration > Object > Certificate > My Certificates > Edit

Edit My Certificates

Configuration

Name:

Certification Path

Refresh

Certificate Information

Type: Self-signed X.509 Certificate
 Version: V3
 Serial Number: 22:2d:69:46:1b:0a:be:f6:3d:f4:f8:01:c6:66:d2:b0:cb:8f:2c:da
 Subject: CN = wax620d-6e_1071B31B72E5
 Issuer: CN = wax620d-6e_1071B31B72E5
 Signature Algorithm: sha256WithRSAEncryption
 Valid From: 2022-05-12 12:00:07 GMT
 Valid To: 2032-05-09 12:00:07 GMT
 Key Algorithm: rsaEncryption (2048 bit)
 Subject Alternative Name: wax620d-6e_1071B31B72E5
 Key Usage: Digital Signature, Key Encipherment, Data Encipherment, Certificate Sign
 Extended Key Usage:
 Basic Constraint: Subject Type=CA, Path Length Constraint=1
 MD5 Fingerprint: 7A:0A:54:7C:2C:05:EC:3E:E0:AC:EE:04:D0:C8:84:CC
 SHA1 Fingerprint: 45:40:2E:13:60:9A:7B:8A:51:EE:D6:7D:ED:67:02:CE:78:A3:D9:80

Certificate in PEM (Base-64) Encoded Format

```
-----BEGIN X509 CERTIFICATE-----
MIIDZjCCAk6gAwIBAgIUl1pRhsKvvY99PgBxmbSsMuPLNowDQYJKoZIhvcNAQEL
BQAwIjEgMB4GA1UEAwwXd2F4620d-6e_1071B31B72E5
MTIwMDA3WhcNMzIwMDA3WjAiMSAwHgYDVQDDbD3YXg2MjBkLTZlXzEw
NzFCMzFCNzJFNTCCASIwDQYJKoZIhvcNAQEBBQADggEPADCCAQoCggEBANYrfwNO
4+t4Rq3dZs+cBM5L/5WD/XglSVZEgNQEBNTifwHUWgFY8OM6/yy1fR+9W06vZmac
nFL1xlycwA0iYrix8oYD37NDXgnsGMIz5xDG3530FxxM+IEfGrLJXnctFPYFI7
PPYmyuOahAb5U9Mnh6X6bjdwzGbQz0fYDEObkriqTvDBMRKkKehCsqqjn3z1G3y0w
Pw/C8pChLwMNOtZbLpuf8eFNhmz1ni4T/41nua8Q1eHYNziKY7C4YlWkq2E1
-----
```

Password:

Export Certificate Only **Export Certificate with Private Key**

OK **Cancel**

The following table describes the labels in this screen.

Table 83 Configuration > Object > Certificate > My Certificates > Edit

LABEL	DESCRIPTION
Name	This field displays the identifying name of this certificate. You can use up to 31 alphanumeric and ;'~!@#\$\$%^&()_+[]{}',.- characters.
<p>Certification Path</p> <p>This field displays for a certificate, not a certification request.</p> <p>Click the Refresh button to have this read-only text box display the hierarchy of certification authorities that validate the certificate (and the certificate itself).</p> <p>If the issuing certification authority is one that you have imported as a trusted certification authority, it may be the only certification authority in the list (along with the certificate itself). If the certificate is a self-signed certificate, the certificate itself is the only one in the list. The Zyxel Device does not trust the certificate and displays "Not trusted" in this field if any certificate on the path has expired or been revoked.</p>	
Refresh	Click Refresh to display the certification path.
<p>Certificate Information</p> <p>These read-only fields display detailed information about the certificate.</p>	
Type	This field displays general information about the certificate. CA-signed means that a Certification Authority signed the certificate. Self-signed means that the certificate's owner signed the certificate (not a certification authority). "X.509" means that this certificate was created and signed according to the ITU-T X.509 recommendation that defines the formats for public-key certificates.
Version	This field displays the X.509 version number.
Serial Number	This field displays the certificate's identification number given by the certification authority or generated by the Zyxel Device.
Subject	This field displays information that identifies the owner of the certificate, such as Common Name (CN), Organizational Unit (OU), Organization (O), State (ST), and Country (C).
Issuer	<p>This field displays identifying information about the certificate's issuing certification authority, such as Common Name, Organizational Unit, Organization and Country.</p> <p>With self-signed certificates, this is the same as the Subject Name field.</p> <p>"none" displays for a certification request.</p>
Signature Algorithm	This field displays the type of algorithm that was used to sign the certificate.
Valid From	This field displays the date that the certificate becomes applicable. "none" displays for a certification request.
Valid To	This field displays the date that the certificate expires. The text displays in red and includes an Expired! message if the certificate has expired. "none" displays for a certification request.
Key Algorithm	This field displays the type of algorithm that was used to generate the certificate's key pair (the Zyxel Device uses RSA encryption) and the length of the key set in bits (1024 bits for example).
Subject Alternative Name	This field displays the certificate owner's IP address (IP), domain name (DNS) or email address (EMAIL).
Key Usage	This field displays for what functions the certificate's key can be used. For example, "DigitalSignature" means that the key can be used to sign certificates and "KeyEncipherment" means that the key can be used to encrypt text.
Extended Key Usage	This field displays for what EKU (Extended Key Usage) functions the certificate's key can be used.
Basic Constraint	This field displays general information about the certificate. For example, Subject Type=CA means that this is a certification authority's certificate and "Path Length Constraint=1" means that there can only be one certification authority in the certificate's path. This field does not display for a certification request.

Table 83 Configuration > Object > Certificate > My Certificates > Edit

LABEL	DESCRIPTION
MD5 Fingerprint	This is the certificate's message digest that the Zyxel Device calculated using the MD5 algorithm.
SHA1 Fingerprint	This is the certificate's message digest that the Zyxel Device calculated using the SHA1 algorithm.
SHA256 Fingerprint	This is the certificate's message digest that the Zyxel Device calculated using the SHA256 algorithm.
Certificate in PEM (Base-64) Encoded Format	<p>This read-only text box displays the certificate or certification request in Privacy Enhanced Mail (PEM) format. PEM uses lowercase letters, uppercase letters and numerals to convert a binary certificate into a printable form.</p> <p>You can copy and paste a certification request into a certification authority's web page, an email that you send to the certification authority or a text editor and save the file on a management computer for later manual enrollment.</p> <p>You can copy and paste a certificate into an email to send to friends or colleagues or you can copy and paste a certificate into a text editor and save the file on a management computer for later distribution (through floppy disk for example).</p>
Export Certificate Only	Use this button to save a copy of the certificate without its private key. Click this button and then Save in the File Download screen. The Save As screen opens, browse to the location that you want to use and click Save .
Password	If you want to export the certificate with its private key, create a password and type it here. Make sure you keep this password in a safe place. You will need to use it if you import the certificate to another device.
Export Certificate with Private Key	Use this button to save a copy of the certificate with its private key. Type the certificate's password and click this button. Click Save in the File Download screen. The Save As screen opens, browse to the location that you want to use and click Save .
OK	Click OK to save your changes back to the Zyxel Device. You can only change the name.
Cancel	Click Cancel to quit and return to the My Certificates screen.

15.2.3 Import Certificates

Click **Configuration > Object > Certificate > My Certificates > Import** to open the **My Certificate Import** screen. Follow the instructions in this screen to save an existing certificate to the Zyxel Device.

Note: You can import a certificate that matches a corresponding certification request that was generated by the Zyxel Device. You can also import a certificate in PKCS#12 format, including the certificate's public and private keys.

The certificate you import replaces the corresponding request in the **My Certificates** screen.

You must remove any spaces in the certificate's filename before you can import it.

Figure 131 Configuration > Object > Certificate > My Certificates > Import

The following table describes the labels in this screen.

Table 84 Configuration > Object > Certificate > My Certificates > Import

LABEL	DESCRIPTION
File	Type in the location of the file you want to upload in this field or click Browse to find it. You cannot import a certificate with the same name as a certificate that is already in the Zyxel Device.
Browse	Click Browse to find the certificate file you want to upload.
Password	This field only applies when you import a binary PKCS#12 format file. Type the file's password that was created when the PKCS #12 file was exported.
OK	Click OK to save the certificate on the Zyxel Device.
Cancel	Click Cancel to quit and return to the My Certificates screen.

15.3 Trusted Certificates

Click **Configuration > Object > Certificate > Trusted Certificates** to open the **Trusted Certificates** screen. This screen displays a summary list of certificates that you have set the Zyxel Device to accept as trusted. The Zyxel Device also accepts any valid certificate signed by a certificate on this list as being trustworthy; thus you do not need to import any certificate that is signed by one of these certificates.

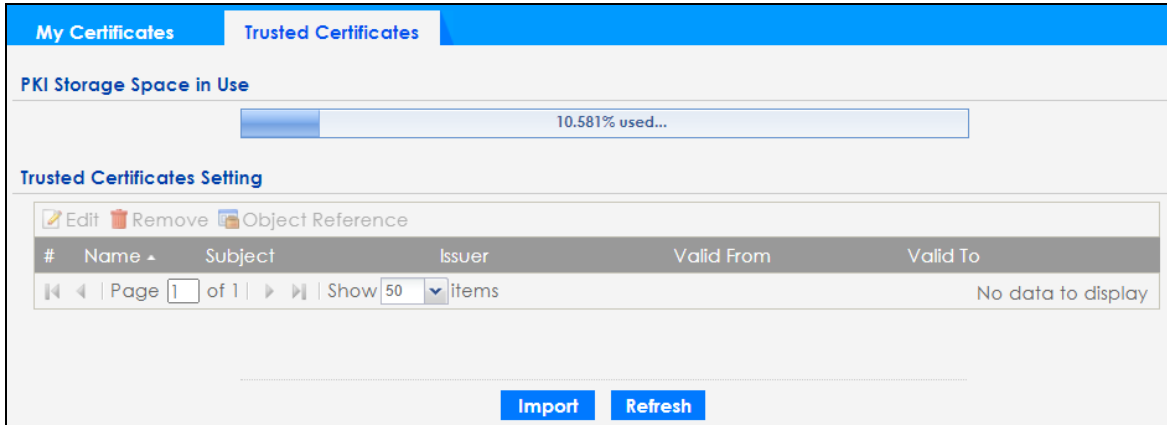
Figure 132 Configuration > Object > Certificate > Trusted Certificates

The following table describes the labels in this screen.

Table 85 Configuration > Object > Certificate > Trusted Certificates

LABEL	DESCRIPTION
PKI Storage Space in Use	This bar displays the percentage of the Zyxel Device's PKI storage space that is currently in use. When the storage space is almost full, you should consider deleting expired or unnecessary certificates before adding more certificates.
Trusted Certificates Setting	
Edit	Double-click an entry or select it and click Edit to open a screen with an in-depth list of information about the certificate.
Remove	The Zyxel Device keeps all of your certificates unless you specifically delete them. Uploading a new firmware or default configuration file does not delete your certificates. To remove an entry, select it and click Remove . The Zyxel Device confirms you want to remove it before doing so. Subsequent certificates move up by one when you take this action.
Object Reference	You cannot delete certificates that any of the Zyxel Device's features are configured to use. Select an entry and click Object Reference to open a screen that shows which settings use the entry.
#	This field displays the certificate index number. The certificates are listed in alphabetical order.
Name	This field displays the name used to identify this certificate.
Subject	This field displays identifying information about the certificate's owner, such as CN (Common Name), OU (Organizational Unit or department), O (Organization or company) and C (Country). It is recommended that each certificate have unique subject information.
Issuer	This field displays identifying information about the certificate's issuing certification authority, such as a common name, organizational unit or department, organization or company and country. With self-signed certificates, this is the same information as in the Subject field.
Valid From	This field displays the date that the certificate becomes applicable.
Valid To	This field displays the date that the certificate expires. The text displays in red and includes an Expired! message if the certificate has expired.
Import	Click Import to open a screen where you can save the certificate of a certification authority that you trust, from your computer to the Zyxel Device.
Refresh	Click this button to display the current validity status of the certificates.

15.3.1 Edit Trusted Certificates

Click **Configuration > Object > Certificate > Trusted Certificates** and then a certificate's **Edit** icon to open the **Trusted Certificates Edit** screen. Use this screen to view in-depth information about the certificate,

The following table describes the labels in this screen.

Table 86 Configuration > Object > Certificate > Trusted Certificates > Edit

LABEL	DESCRIPTION
Configuration	
Name	This field displays the identifying name of this certificate. You can change the name. You can use up to 31 alphanumeric and ;'~!@#\$%^&()_+[]{}',.- characters.
Certification Path	Click the Refresh button to have this read-only text box display the end entity's certificate and a list of certification authority certificates that shows the hierarchy of certification authorities that validate the end entity's certificate. If the issuing certification authority is one that you have imported as a trusted certificate, it may be the only certification authority in the list (along with the end entity's own certificate). The Zyxel Device does not trust the end entity's certificate and displays "Not trusted" in this field if any certificate on the path has expired or been revoked.
Refresh	Click Refresh to display the certification path.
Certificate Validation	
Enable X.509v3 CRL Distribution Points and OCSP checking	Select this checkbox to have the Zyxel Device check incoming certificates that are signed by this certificate against a Certificate Revocation List (CRL) or an OCSP server. You also need to configure the OSCP or LDAP server details.
OCSP Server	Select this checkbox if the directory server uses OCSP (Online Certificate Status Protocol).
URL	Type the protocol, IP address and pathname of the OCSP server.
ID	The Zyxel Device may need to authenticate itself in order to assess the OCSP server. Type the login name (up to 31 ASCII characters) from the entity maintaining the server (usually a certification authority).
Password	Type the password (up to 31 ASCII characters) from the entity maintaining the OCSP server (usually a certification authority).
LDAP Server	Select this checkbox if the directory server uses LDAP (Lightweight Directory Access Protocol). LDAP is a protocol over TCP that specifies how clients access directories of certificates and lists of revoked certificates.
Address	Type the IP address (in dotted decimal notation) of the directory server.
Port	Use this field to specify the LDAP server port number. You must use the same server port number that the directory server uses. 389 is the default server port number for LDAP.
ID	The Zyxel Device may need to authenticate itself in order to assess the CRL directory server. Type the login name (up to 31 ASCII characters) from the entity maintaining the server (usually a certification authority).
Password	Type the password (up to 31 ASCII characters) from the entity maintaining the CRL directory server (usually a certification authority).
Certificate Information	These read-only fields display detailed information about the certificate.
Type	This field displays general information about the certificate. CA-signed means that a Certification Authority signed the certificate. Self-signed means that the certificate's owner signed the certificate (not a certification authority). X.509 means that this certificate was created and signed according to the ITU-T X.509 recommendation that defines the formats for public-key certificates.
Version	This field displays the X.509 version number.
Serial Number	This field displays the certificate's identification number given by the certification authority.
Subject	This field displays information that identifies the owner of the certificate, such as Common Name (CN), Organizational Unit (OU), Organization (O) and Country (C).
Issuer	This field displays identifying information about the certificate's issuing certification authority, such as Common Name, Organizational Unit, Organization and Country. With self-signed certificates, this is the same information as in the Subject Name field.

Table 86 Configuration > Object > Certificate > Trusted Certificates > Edit (continued)

LABEL	DESCRIPTION
Signature Algorithm	This field displays the type of algorithm that was used to sign the certificate. Some certification authorities use rsa-pkcs1-sha1 (RSA public-private key encryption algorithm and the SHA1 hash algorithm). Other certification authorities may use rsa-pkcs1-md5 (RSA public-private key encryption algorithm and the MD5 hash algorithm).
Valid From	This field displays the date that the certificate becomes applicable. The text displays in red and includes a Not Yet Valid! message if the certificate has not yet become applicable.
Valid To	This field displays the date that the certificate expires. The text displays in red and includes an Expiring! or Expired! message if the certificate is about to expire or has already expired.
Key Algorithm	This field displays the type of algorithm that was used to generate the certificate's key pair (the Zyxel Device uses RSA encryption) and the length of the key set in bits (1024 bits for example).
Subject Alternative Name	This field displays the certificate's owner's IP address (IP), domain name (DNS) or email address (EMAIL).
Key Usage	This field displays for what functions the certificate's key can be used. For example, "DigitalSignature" means that the key can be used to sign certificates and "KeyEncipherment" means that the key can be used to encrypt text.
Basic Constraint	This field displays general information about the certificate. For example, Subject Type=CA means that this is a certification authority's certificate and "Path Length Constraint=1" means that there can only be one certification authority in the certificate's path.
MD5 Fingerprint	This is the certificate's message digest that the Zyxel Device calculated using the MD5 algorithm. You can use this value to verify with the certification authority (over the phone for example) that this is actually their certificate.
SHA1 Fingerprint	This is the certificate's message digest that the Zyxel Device calculated using the SHA1 algorithm. You can use this value to verify with the certification authority (over the phone for example) that this is actually their certificate.
Certificate	<p>This read-only text box displays the certificate or certification request in Privacy Enhanced Mail (PEM) format. PEM uses lowercase letters, uppercase letters and numerals to convert a binary certificate into a printable form.</p> <p>You can copy and paste the certificate into an email to send to friends or colleagues or you can copy and paste the certificate into a text editor and save the file on a management computer for later distribution (through floppy disk for example).</p>
Export Certificate	Click this button and then Save in the File Download screen. The Save As screen opens, browse to the location that you want to use and click Save .
OK	Click OK to save your changes back to the Zyxel Device. You can only change the name.
Cancel	Click Cancel to quit and return to the Trusted Certificates screen.

15.3.2 Import Trusted Certificates

Click **Configuration > Object > Certificate > Trusted Certificates > Import** to open the **Import Trusted Certificates** screen. Follow the instructions in this screen to save a trusted certificate to the Zyxel Device.

Note: You must remove any spaces from the certificate's filename before you can import the certificate.

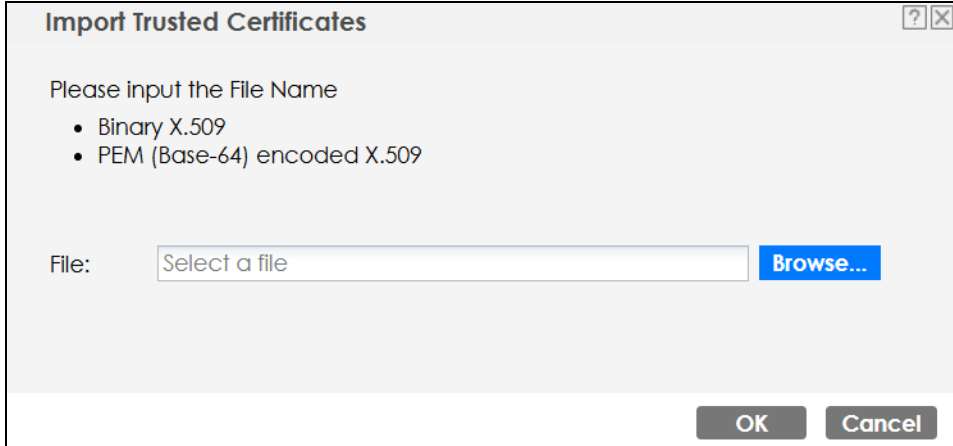
Figure 134 Configuration > Object > Certificate > Trusted Certificates > Import

The following table describes the labels in this screen.

Table 87 Configuration > Object > Certificate > Trusted Certificates > Import

LABEL	DESCRIPTION
File	Type in the location of the file you want to upload in this field or click Browse to find it. You cannot import a certificate with the same name as a certificate that is already in the Zyxel Device.
Browse	Click Browse to find the certificate file you want to upload.
OK	Click OK to save the certificate on the Zyxel Device.
Cancel	Click Cancel to quit and return to the previous screen.

15.4 Technical Reference

The following section contains additional technical information about the features described in this chapter.

OCSP

OCSP (Online Certificate Status Protocol) allows an application or device to check whether a certificate is valid. With OCSP the Zyxel Device checks the status of individual certificates instead of downloading a Certificate Revocation List (CRL). OCSP has two main advantages over a CRL. The first is real-time status information. The second is a reduction in network traffic since the Zyxel Device only gets information on the certificates that it needs to verify, not a huge list. When the Zyxel Device requests certificate status information, the OCSP server returns a "expired", "current" or "unknown" response.

CHAPTER 16

System

16.1 Overview

Use the system screens to configure general Zyxel Device settings.

16.1.1 What You Can Do in this Chapter

- The **Host Name** screen ([Host Name](#)) configures a unique name for the Zyxel Device in your network.
- The **Power Mode** screen ([Power Mode](#)) configures the Zyxel Device's power settings.
- The **Date/Time** screen ([Date and Time](#)) configures the date and time for the Zyxel Device.
- The **WWW** screens ([WWW Overview](#)) configure settings for HTTP or HTTPS access to the Zyxel Device.
- The **SSH** screen ([SSH](#)) configures SSH (Secure SHell) for securely accessing the Zyxel Device's command line interface.
- The **FTP** screen ([FTP](#)) specifies FTP server settings. You can upload and download the Zyxel Device's firmware and configuration files using FTP. Please also see [File Manager](#) for more information about firmware and configuration files.

16.2 Host Name

A host name is the unique name by which a device is known on a network. Click **Configuration > System > Host Name** to open this screen.

Figure 135 Configuration > System > Host Name

The screenshot shows the 'Host Name' configuration page. The title bar is blue and contains the text 'Host Name'. Below the title bar, there is a section titled 'General Settings'. This section contains three rows of configuration options, each with a text input field and a label '(Optional)'. The first row is 'System Name:' with the input field containing 'NWA50BE-PRO'. The second row is 'System Location:' with an empty input field. The third row is 'Domain Name:' with an empty input field. At the bottom of the form, there are two blue buttons: 'Apply' and 'Reset'.

The following table describes the labels in this screen.

Table 88 Configuration > System > Host Name

LABEL	DESCRIPTION
General Settings	
System Name	Choose a descriptive name to identify your Zyxel Device device. This name can be up to 64 alphanumeric characters long. Spaces are not allowed, but dashes (-) underscores (_) and periods (.) are accepted.
System Location	Specify the name of the place where the Zyxel Device is located. You can enter up to 60 alphanumeric and '() ,;?! +-*/= #\$\$%@ characters. Spaces and underscores are allowed. The name should start with a letter.
Domain Name	Enter the domain name (if you know it) here. This name is propagated to DHCP clients connected to interfaces with the DHCP server enabled. This name can be up to 254 alphanumeric characters long. Spaces are not allowed, but dashes "-" are accepted.
Apply	Click Apply to save your changes back to the Zyxel Device.
Reset	Click Reset to return the screen to its last-saved settings.

16.3 Power Mode

Use this screen to configure the Zyxel Device's power settings. Click **Configuration > System > Power Mode** to open this screen.

Figure 136 Configuration > System > Power Mode

The following table describes the labels in this screen.

Table 89 Configuration > System > Power Mode

LABEL	DESCRIPTION
Force override the power mode to full power	Select this checkbox if you are using a PoE injector that does not support PoE negotiation. Otherwise, the Zyxel Device cannot draw full power from the power sourcing equipment. Enable this power mode to improve the Zyxel Device's performance in this situation. Note: Ensure that the power sourcing equipment can supply enough power to the AP to avoid abnormal system reboots. Note: Only enable this if you are using a passive PoE injector that is not IEEE 802.3at/bt compliant but can still provide full power.
Apply	Click Apply to save your changes back to the Zyxel Device.
Reset	Click Reset to return the screen to its last-saved settings.

16.4 Date and Time

For effective scheduling and logging, the Zyxel Device system time must be accurate. The Zyxel Device has a software mechanism to set the time manually or get the current time and date from an external server.

To change your Zyxel Device's time based on your local time zone and date, click **Configuration > System > Date/Time**. The screen displays as shown. You can manually set the Zyxel Device's time and date or have the Zyxel Device get the date and time from a time server.

Figure 137 Configuration > System > Date/Time

The following table describes the labels in this screen.

Table 90 Configuration > System > Date/Time

LABEL	DESCRIPTION
Current Time and Date	
Current Time	This field displays the present time of your Zyxel Device.
Current Date	This field displays the present date of your Zyxel Device.
Time and Date Setup	
Manual	Select this radio button to enter the time and date manually. If you configure a new time and date, time zone and daylight saving at the same time, the time zone and daylight saving will affect the new time and date you entered. When you enter the time settings manually, the Zyxel Device uses the new setting once you click Apply .
New Time (hh:mm:ss)	This field displays the last updated time from the time server or the last time configured manually. When you set Time and Date Setup to Manual , enter the new time in this field and then click Apply .

Table 90 Configuration > System > Date/Time (continued)

LABEL	DESCRIPTION
New Date (yyyy-mm-dd)	This field displays the last updated date from the time server or the last date configured manually. When you set Time and Date Setup to Manual , enter the new date in this field and then click Apply .
Get from Time Server	Select this radio button to have the Zyxel Device get the time and date from the time server you specify below. The Zyxel Device requests time and date settings from the time server under the following circumstances. <ul style="list-style-type: none"> • When the Zyxel Device starts up. • When you click Apply or Sync. Now in this screen. • 24-hour intervals after starting up.
Time Server Address	Enter the IP address or URL of your time server. Check with your ISP/network administrator if you are unsure of this information.
Sync. Now	Click this button to have the Zyxel Device get the time and date from a time server (see the Time Server Address field). This also saves your changes (except the daylight saving settings).
Time Zone Setup	
Time Zone	Choose the time zone of your location. This will set the time difference between your time zone and Greenwich Mean Time (GMT).
Enable Daylight Saving	Daylight saving is a period from late spring to fall when many countries set their clocks ahead of normal local time by one hour to give more daytime light in the evening. Select this option if you use Daylight Saving Time.
Start Date	Configure the day and time when Daylight Saving Time starts if you selected Enable Daylight Saving . The at field uses the 24 hour format. Here are a couple of examples: Daylight Saving Time starts in most parts of the United States on the second Sunday of March. Each time zone in the United States starts using Daylight Saving Time at 2 A.M. local time. So in the United States you would select Second, Sunday, March and type 2 in the at field. Daylight Saving Time starts in the European Union on the last Sunday of March. All of the time zones in the European Union start using Daylight Saving Time at the same moment (1 A.M. GMT or UTC). So in the European Union you would select Last, Sunday, March . The time you type in the at field depends on your time zone. In Germany for instance, you would type 2 because Germany's time zone is one hour ahead of GMT or UTC (GMT+1).
End Date	Configure the day and time when Daylight Saving Time ends if you selected Enable Daylight Saving . The at field uses the 24 hour format. Here are a couple of examples: Daylight Saving Time ends in the United States on the first Sunday of November. Each time zone in the United States stops using Daylight Saving Time at 2 A.M. local time. So in the United States you would select First, Sunday, November and type 2 in the at field. Daylight Saving Time ends in the European Union on the last Sunday of October. All of the time zones in the European Union stop using Daylight Saving Time at the same moment (1 A.M. GMT or UTC). So in the European Union you would select Last, Sunday, October . The time you type in the at field depends on your time zone. In Germany for instance, you would type 2 because Germany's time zone is one hour ahead of GMT or UTC (GMT+1).
Offset	Specify how much the clock changes when daylight saving begins and ends. Enter a number from 1 to 5.5 (by 0.5 increments). For example, if you set this field to 3.5, a log occurred at 6 P.M. in local official time will appear as if it had occurred at 10:30 P.M.
Apply	Click Apply to save your changes back to the Zyxel Device.
Reset	Click Reset to return the screen to its last-saved settings.

16.4.1 Pre-defined NTP Time Servers List

When you turn on the Zyxel Device for the first time, the date and time start at 2003-01-01 00:00:00. The Zyxel Device then attempts to synchronize with one of the following pre-defined list of Network Time Protocol (NTP) time servers in order from the first one until it is successful.

Table 91 Default Time Servers

time.windows.com
time.apple.com
time.cloudflare.com

The Zyxel Device continues to use the pre-defined list of NTP time servers if you do not specify a time server or it cannot synchronize with the time server you specified.

16.4.2 Time Server Synchronization

Click the **Sync. Now** button to get the time and date from the time server you specified in the **Time Server Address** field.

When the **Loading** message appears, you may have to wait up to one minute.

Figure 138 Loading

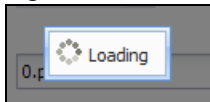

The **Current Time** and **Current Date** fields will display the appropriate settings if the synchronization is successful.

If the synchronization was not successful, a log displays in the **View Log** screen. Try re-configuring the **Date/Time** screen.

To manually set the Zyxel Device date and time:

- 1 Click **System > Date/Time**.
- 2 Select **Manual** under **Time and Date Setup**.
- 3 Enter the Zyxel Device's time in the **New Time** field.
- 4 Enter the Zyxel Device's date in the **New Date** field.
- 5 Under **Time Zone Setup**, select your **Time Zone** from the list.
- 6 As an option you can select the **Enable Daylight Saving** checkbox to adjust the Zyxel Device clock for daylight savings.
- 7 Click **Apply**.

To get the Zyxel Device date and time from a time server:

- 1 Click **System > Date/Time**.

- 2 Select **Get from Time Server** under **Time and Date Setup**.
- 3 Under **Time Zone Setup**, select your **Time Zone** from the list.
- 4 Under **Time and Date Setup**, enter a **Time Server Address**.
- 5 Click **Apply**.

16.5 WWW Overview

The following figure shows secure and insecure management of the Zyxel Device coming in from the WAN. HTTPS and SSH access are secure. HTTP and FTP management access are not secure.

Figure 139 Secure and Insecure Service Access From the WAN

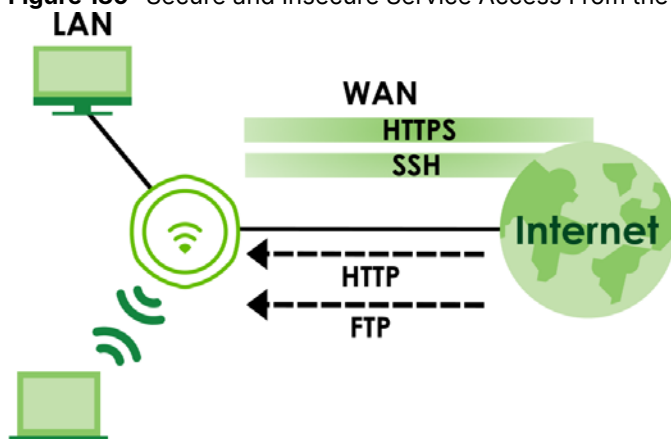

16.5.1 Service Access Limitations

A service cannot be used to access the Zyxel Device when you have disabled that service in the corresponding screen.

16.5.2 System Timeout

There is a lease timeout for administrators. The Zyxel Device automatically logs you out if the management session remains idle for longer than this timeout period. The management session does not time out when a statistics screen is polling.

Each user is also forced to log in the Zyxel Device for authentication again when the reauthentication time expires.

You can change the timeout settings in the **User** screens.

16.5.3 HTTPS

You can set the Zyxel Device to use HTTP or HTTPS (HTTPS adds security) for Web Configurator sessions.

HTTPS (HyperText Transfer Protocol over Secure Socket Layer, or HTTP over SSL) is a web protocol that encrypts and decrypts web pages. Secure Socket Layer (SSL) is an application-level protocol that enables secure transactions of data by ensuring confidentiality (an unauthorized party cannot read the transferred data), authentication (one party can identify the other party) and data integrity (you know if data has been changed).

It relies upon certificates, public keys, and private keys (see [Certificates](#) for more information).

HTTPS on the Zyxel Device is used so that you can securely access the Zyxel Device using the Web Configurator. The SSL protocol specifies that the HTTPS server (the Zyxel Device) must always authenticate itself to the HTTPS client (the computer which requests the HTTPS connection with the Zyxel Device), whereas the HTTPS client only should authenticate itself when the HTTPS server requires it to do so (select **Authenticate Client Certificates** in the **WWW** screen). **Authenticate Client Certificates** is optional and if selected means the HTTPS client must send the Zyxel Device a certificate. You must apply for a certificate for the browser from a CA that is a trusted CA on the Zyxel Device.

Please refer to the following figure.

- 1 HTTPS connection requests from an SSL-aware web browser go to port 443 (by default) on the Zyxel Device's web server.
- 2 HTTP connection requests from a web browser go to port 80 (by default) on the Zyxel Device's web server.

Figure 140 HTTP/HTTPS Implementation

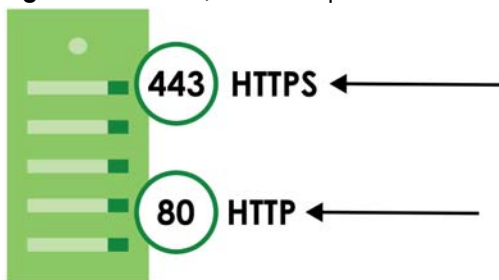

Note: If you disable **HTTP** in the **WWW** screen, then the Zyxel Device blocks all HTTP connection attempts.

16.5.4 Configuring WWW Service Control

Click **Configuration > System > WWW** to open the **WWW** screen. Use this screen to specify HTTP or HTTPS settings.

Figure 141 Configuration > System > WWW > Service Control

Service Control

HTTPS

Enable

Server Port:

Authenticate Client Certificates (See [Trusted CAs](#))

Server Certificate:

Redirect HTTP to HTTPS

HTTP

Enable

Server Port:

Apply **Reset**

The following table describes the labels in this screen.

Table 92 Configuration > System > WWW > Service Control

LABEL	DESCRIPTION
HTTPS	
Enable	Select the checkbox to allow or disallow the computer with the IP address that matches the IP address(es) in the Service Control table to access the Zyxel Device Web Configurator using secure HTTPs connections.
Server Port	The HTTPS server listens on port 443 by default. If you change the HTTPS server port to a different number on the Zyxel Device, for example 8443, then you must notify people who need to access the Zyxel Device Web Configurator to use "https://Zyxel Device IP Address: 8443 " as the URL.
Authenticate Client Certificates	Select Authenticate Client Certificates (optional) to require the SSL client to authenticate itself to the Zyxel Device by sending the Zyxel Device a certificate. To do that the SSL client must have a CA-signed certificate from a CA that has been imported as a trusted CA on the Zyxel Device. Click Trusted CAs to go to the Configuration > Object > Certificate > Trusted Certificates screen and check for the trusted certificates settings.
Server Certificate	Select a certificate the HTTPS server (the Zyxel Device) uses to authenticate itself to the HTTPS client. You must have certificates already configured in the My Certificates screen.
Redirect HTTP to HTTPS	To allow only secure Web Configurator access, select this to redirect all HTTP connection requests to the HTTPS server.
HTTP	
Enable	Select the checkbox to allow or disallow the computer with the IP address that matches the IP address(es) in the Service Control table to access the Zyxel Device Web Configurator using HTTP connections.
Server Port	You may change the server port number for a service if needed, however you must use the same port number in order to use that service to access the Zyxel Device.
Apply	Click Apply to save your changes back to the Zyxel Device.
Reset	Click Reset to return the screen to its last-saved settings.

16.5.5 HTTPS Example

If you have not changed the default HTTPS port on the Zyxel Device, then in your browser enter "https:// Zyxel Device IP Address/" as the web site address where "Zyxel Device IP Address" is the IP address or domain name of the Zyxel Device you wish to access.

16.5.5.1 Google Chrome Warning Messages

When you attempt to access the Zyxel Device HTTPS server, you will see the error message shown in the following screen.

Figure 142 Security Alert Dialog Box (Google Chrome)

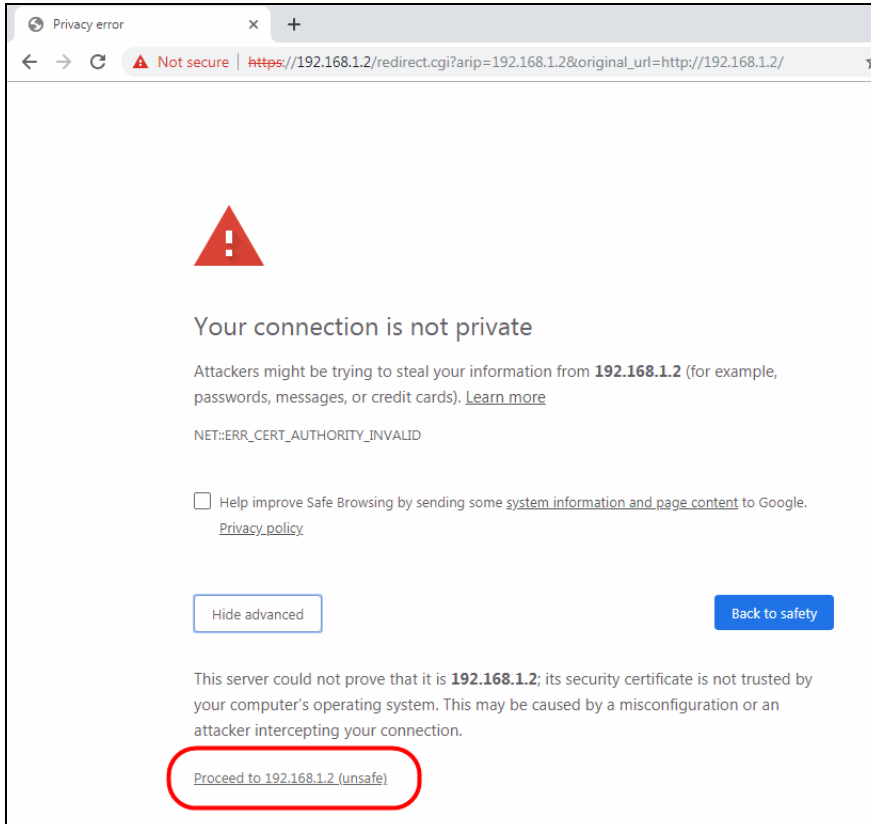

Select **Advanced > Proceed to 192.168.1.2 (unsafe)** to proceed to the Web Configurator login screen.

16.5.5.2 Mozilla Firefox Warning Messages

When you attempt to access the Zyxel Device HTTPS server, a Warning screen appears as shown in the following screen. Click **Learn More...** if you want to verify more information about the certificate from the Zyxel Device.

Click **Advanced > Accept the Risk and Continue.**

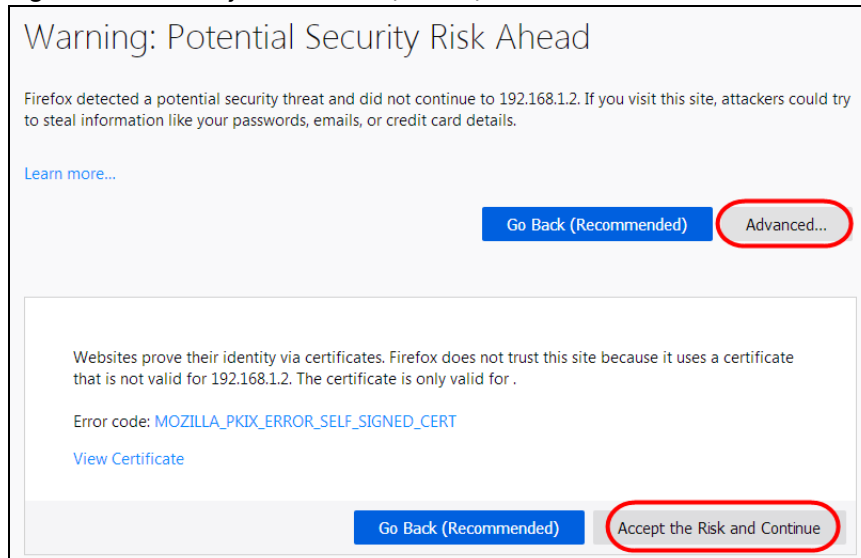
Figure 143 Security Certificate 1 (Firefox)

16.5.5.3 Avoiding Browser Warning Messages

Here are the main reasons your browser displays warnings about the Zyxel Device's HTTPS server certificate and what you can do to avoid seeing the warnings:

- The issuing certificate authority of the Zyxel Device's HTTPS server certificate is not one of the browser's trusted certificate authorities. The issuing certificate authority of the Zyxel Device's factory default certificate is the Zyxel Device itself since the certificate is a self-signed certificate.
- For the browser to trust a self-signed certificate, import the self-signed certificate into your operating system as a trusted certificate.
- To have the browser trust the certificates issued by a certificate authority, import the certificate authority's certificate into your operating system as a trusted certificate. Refer to [Appendix B on page 342](#) for details.

16.5.5.4 Enrolling and Importing SSL Client Certificates

The SSL client needs a certificate if **Authenticate Client Certificates** is selected on the Zyxel Device.

You must have imported at least one trusted CA to the Zyxel Device in order for the **Authenticate Client Certificates** to be active (see the Certificates chapter for details).

Apply for a certificate from a Certification Authority (CA) that is trusted by the Zyxel Device (see the Zyxel Device's **Trusted Certificates** Web Configurator screen).

Figure 144 Trusted Certificates

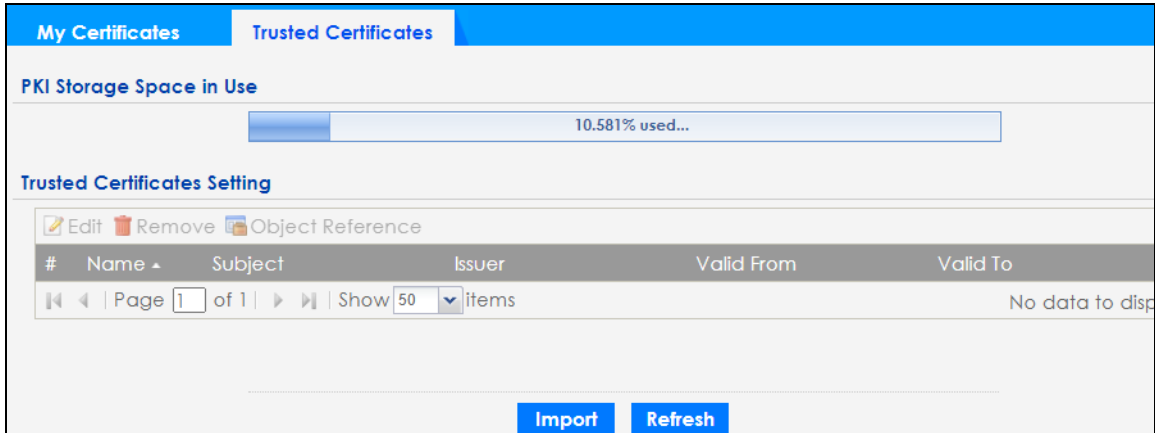

The CA sends you a package containing the CA's trusted certificate(s), your personal certificate(s) and a password to install the personal certificate(s).

16.5.5.5 Installing a Personal Certificate

You need a password in advance. The CA may issue the password or you may have to specify it during the enrollment. Double-click the personal certificate given to you by the CA to produce a screen similar to the one shown next.

- 1 Click **Next** to begin the wizard.



- 2 The file name and path of the certificate you double-clicked should automatically appear in the **File name** text box. Click **Browse** if you wish to import a different certificate.

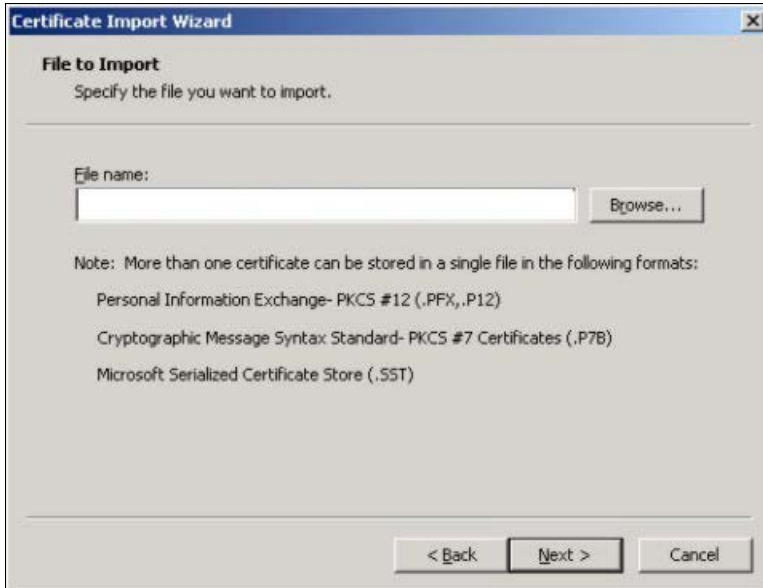

- 3 Enter the password given to you by the CA.



- 4 Have the wizard determine where the certificate should be saved on your computer or select **Place all certificates in the following store** and choose a different location.

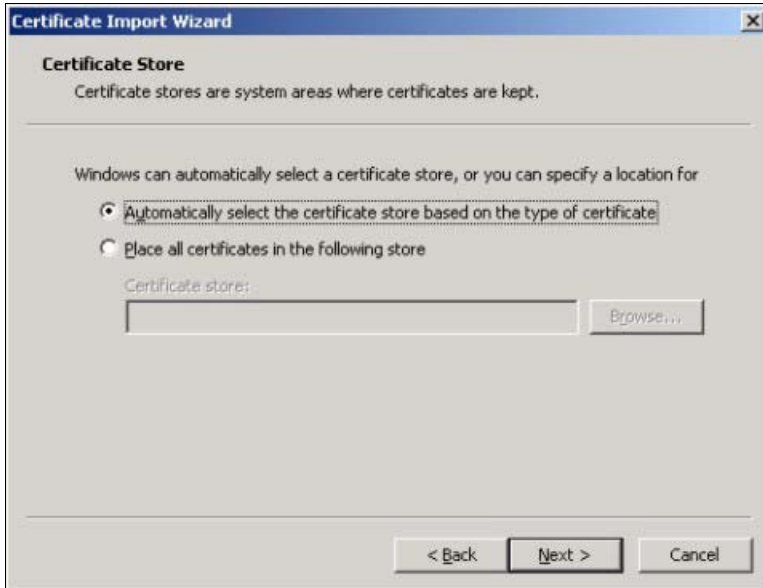

- 5 Click **Finish** to complete the wizard and begin the import process.



- 6 You should see the following screen when the certificate is correctly installed on your computer.



16.5.5.6 Using a Certificate When Accessing the Zyxel Device

To access the Zyxel Device through HTTPS:

- 1 Enter 'https://Zyxel Device IP Address/' in your browser's web address field.

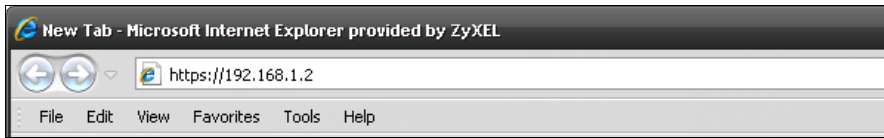

- 2 When **Authenticate Client Certificates** is selected on the Zyxel Device, the following screen asks you to select a personal certificate to send to the Zyxel Device. This screen displays even if you only have a single certificate as in the example.

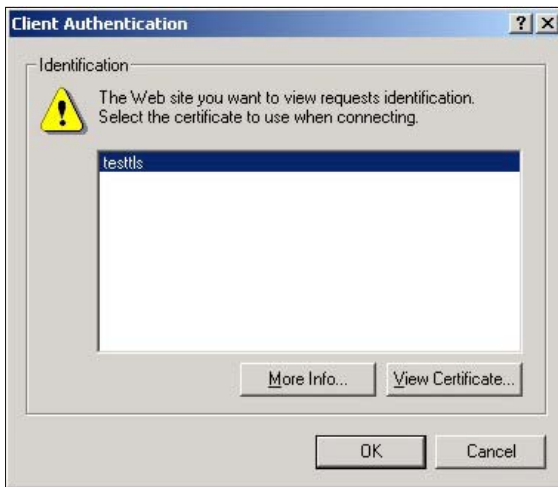

- 3 You next see the Web Configurator login screen.

16.6 SSH

You can use SSH (Secure SHell) to securely access the Zyxel Device's command line interface.

SSH is a secure communication protocol that combines authentication and data encryption to provide secure encrypted communication between two hosts over an unsecured network. In the following figure, the computer on the Internet uses SSH to securely connect (**SC**) to the Zyxel Device for a management session.

Figure 145 SSH Communication Over the WAN Example



16.6.1 How SSH Works

The following figure is an example of how a secure connection is established between two remote hosts using SSH v1.

Figure 146 How SSH v1 Works Example

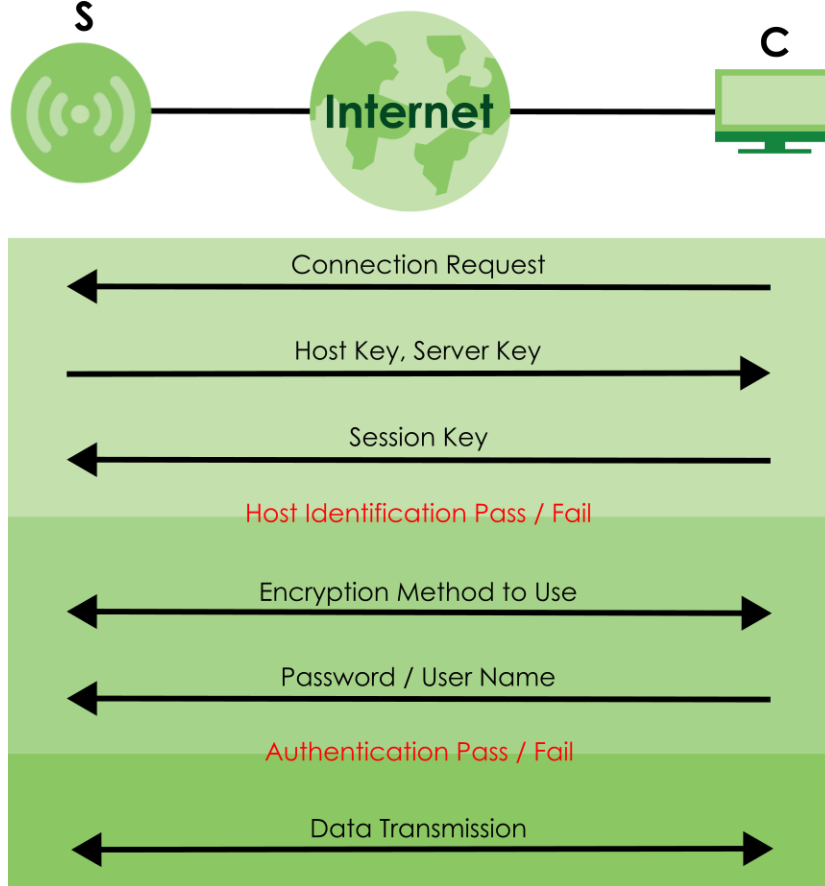

1 Host Identification

The SSH client (**C**) sends a connection request to the SSH server (**S**). The server identifies itself with a host key. The client encrypts a randomly generated session key with the host key and server key and sends the result back to the server.

The client automatically saves any new server public keys. In subsequent connections, the server public key is checked against the saved version on the client computer.

2 Encryption Method

Once the identification is verified, both the client and server must agree on the type of encryption method to use.

3 Authentication and Data Transmission

After the identification is verified and data encryption activated, a secure tunnel is established between the client and the server. The client then sends its authentication information (user name and password) to the server to log in to the server.

16.6.2 SSH Implementation on the Zyxel Device

Your Zyxel Device supports SSH versions 1 and 2 using RSA authentication and four encryption methods (AES, 3DES, Archfour, and Blowfish). The SSH server is implemented on the Zyxel Device for management using port 22 (by default).

16.6.3 Requirements for Using SSH

You must install an SSH client program on a client computer (Windows or Linux operating system) that is used to connect to the Zyxel Device over SSH.

16.6.4 Configuring SSH

Click **Configuration > System > SSH** to open the following screen. Use this screen to configure your Zyxel Device's Secure Shell settings.

Note: It is recommended that you disable FTP when you configure SSH for secure connections.

Figure 147 Configuration > System > SSH

The following table describes the labels in this screen.

Table 93 Configuration > System > SSH

LABEL	DESCRIPTION
Enable	Select the checkbox to allow or disallow the computer with the IP address that matches the IP address(es) in the Service Control table to access the Zyxel Device CLI using this service. Note: The Zyxel Device uses only SSH version 2 protocol.
Server Port	You may change the server port number for a service if needed, however you must use the same port number in order to use that service for remote management.
Server Certificate	Select the certificate whose corresponding private key is to be used to identify the Zyxel Device for SSH connections. You must have certificates already configured in the My Certificates screen.
Apply	Click Apply to save your changes back to the Zyxel Device.
Reset	Click Reset to return the screen to its last-saved settings.

16.6.5 Examples of Secure Telnet Using SSH

This section shows two examples using a command interface and a graphical interface SSH client program to remotely access the Zyxel Device. The configuration and connection steps are similar for most SSH client programs. Refer to your SSH client program user's guide.

16.6.5.1 Example 1: Microsoft Windows

This section describes how to access the Zyxel Device using the Secure Shell Client program.

- 1 Launch the SSH client and specify the connection information (IP address, port number) for the Zyxel Device.
- 2 Configure the SSH client to accept connection using SSH version 2.
- 3 A window displays prompting you to store the host key in you computer. Click **Yes** to continue.

Figure 148 SSH Example 1: Store Host Key

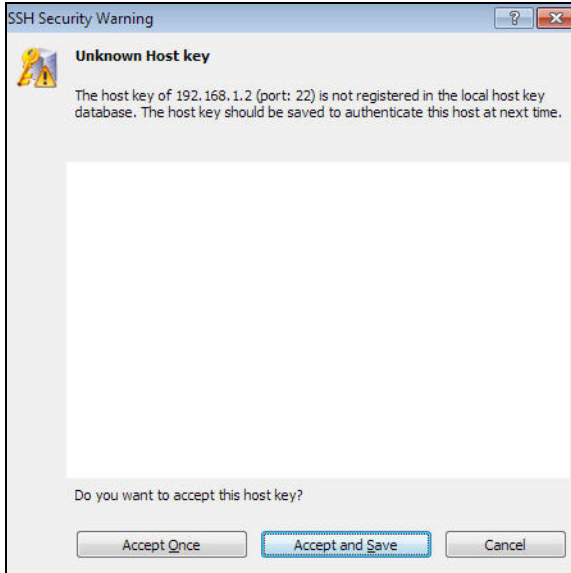

Enter the password to log in to the Zyxel Device. The CLI screen displays next.

16.6.5.2 Example 2: Linux

This section describes how to access the Zyxel Device using the OpenSSH client program that comes with most Linux distributions.

- 1 Enter `ssh -2 192.168.1.2` at a terminal prompt and press [ENTER]. This command forces your computer to connect to the Zyxel Device using SSH version 1. If this is the first time you are connecting to the Zyxel Device using SSH, a message displays prompting you to save the host information of the Zyxel Device. Type `yes` and press [ENTER].

Then enter the password to log in to the Zyxel Device.

Figure 149 SSH Example 2: Log in

```
$ ssh -2 192.168.1.2
The authenticity of host '192.168.1.2 (192.168.1.2)' can't be established.
RSA1 key fingerprint is 21:6c:07:25:7e:f4:75:80:ec:af:bd:d4:3d:80:53:d1.
Are you sure you want to continue connecting (yes/no)? yes
Warning: Permanently added '192.168.1.2' (RSA1) to the list of known hosts.
Administrator@192.168.1.2's password:
```

- 2 The CLI screen displays next.

16.7 FTP

You can upload and download the Zyxel Device's firmware and configuration files using FTP. To use this feature, your computer must have an FTP client. See [File Manager](#) for more information about firmware and configuration files. To change your Zyxel Device's FTP settings, click **Configuration > System > FTP** tab. The screen appears as shown. Use this screen to specify FTP settings.

Figure 150 Configuration > System > FTP

The following table describes the labels in this screen.

Table 94 Configuration > System > FTP

LABEL	DESCRIPTION
Enable	Select the checkbox to allow or disallow the computer with the IP address that matches the IP address(es) in the Service Control table to access the Zyxel Device using this service.
TLS required	Select the checkbox to use FTP over TLS (Transport Layer Security) to encrypt communication. This implements TLS as a security mechanism to secure FTP clients and/or servers.
Server Port	You may change the server port number for a service if needed, however you must use the same port number in order to use that service for remote management.
Server Certificate	Select the certificate whose corresponding private key is to be used to identify the Zyxel Device for FTP connections. You must have certificates already configured in the My Certificates screen.
Apply	Click Apply to save your changes back to the Zyxel Device.
Reset	Click Reset to return the screen to its last-saved settings.

CHAPTER 17

Log and Report

17.1 Overview

Use the system screens to configure daily reporting and log settings.

17.1.1 What You Can Do In this Chapter

- The **Log Setting** screens ([Log Setting](#)) specify which logs are emailed, where they are emailed, and how often they are emailed.

17.2 Log Setting

These screens control log messages and alerts. A log message stores the information for viewing (for example, in the **Monitor > View Log** screen). Usually, alerts are used for events that require more serious attention, such as system errors and attacks.

The **Log Setting** screen provides a summary of all the settings. You can use the **Edit Log Setting** screen to maintain the detailed settings (such as log categories, server names, etc.) for any log. Alternatively, if you want to edit what events is included in each log, you can also use the **Active Log Summary** screen to edit this information for all logs at the same time.

17.2.1 Log Setting Screen

To access this screen, click **Configuration > Log & Report > Log Setting**.

Figure 151 Configuration > Log & Report > Log Setting

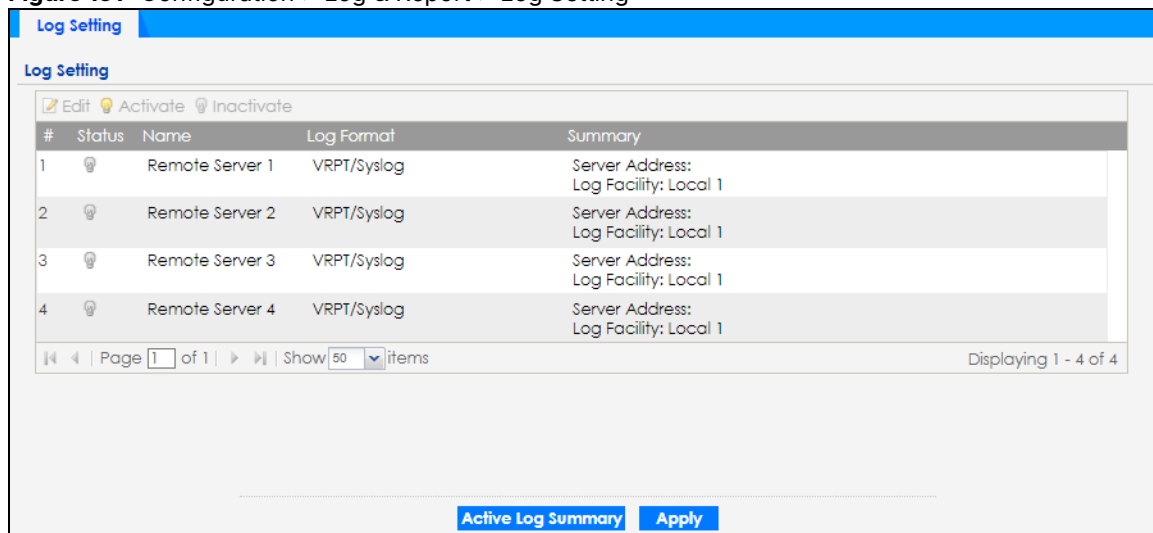

The following table describes the labels in this screen.

Table 95 Configuration > Log & Report > Log Setting

LABEL	DESCRIPTION
Edit	Double-click an entry or select it and click Edit to open a screen where you can modify the entry's settings.
Activate	To turn on an entry, select it and click Activate .
Inactivate	To turn off an entry, select it and click Inactivate .
#	This field is a sequential value, and it is not associated with a specific log.
Status	This field shows whether the log is active or not.
Name	This field displays the name of the log (system log or one of the remote servers).
Log Format	This field displays the format of the log. Internal - system log; you can view the log on the View Log tab. VRPT/Syslog - Zyxel's Vantage Report, syslog-compatible format. CEF/Syslog - Common Event Format, syslog-compatible format.
Summary	This field is a summary of the settings for each log.
Active Log Summary	Click this button to open the Active Log Summary screen.
Apply	Click this button to save your changes (activate and deactivate logs) and make them take effect.

17.2.2 Edit Remote Server

This screen controls the settings for each log in the remote server (syslog). Select a remote server entry in the **Log Setting** screen and click the **Edit** icon.

Figure 152 Configuration > Log & Report > Log Setting > Edit Remote Server

The following table describes the labels in this screen.

Table 96 Configuration > Log & Report > Log Setting > Edit Remote Server

LABEL	DESCRIPTION
Log Settings for Remote Server	
Active	Select this checkbox to send log information according to the information in this section. You specify what kinds of messages are included in log information in the Active Log section.
Log Format	This field displays the format of the log information. It is read-only. VRPT/Syslog - Zyxel's Vantage Report, syslog-compatible format. CEF/Syslog - Common Event Format, syslog-compatible format.
Server Address	Type the server name or the IP address of the syslog server to which to send log information.
Log Facility	Select a log facility. The log facility allows you to log the messages to different files in the syslog server. Please see the documentation for your syslog program for more information.
Active Log	
Selection	Use the Selection drop-down list to change the log settings for all of the log categories. disable all logs (red X) - do not send the remote server logs for any log category. enable normal logs (green check mark) - send the remote server log messages and alerts for all log categories. enable normal logs and debug logs (yellow check mark) - send the remote server log messages, alerts, and debugging information for all log categories.
#	This field is a sequential value, and it is not associated with a specific address.

Table 96 Configuration > Log & Report > Log Setting > Edit Remote Server (continued)

LABEL	DESCRIPTION
Log Category	This field displays each category of messages. It is the same value used in the Display and Category fields in the View Log tab. The Default category includes debugging messages generated by open source software.
Selection	Select what information you want to log from each Log Category (except All Logs ; see below). Choices are: disable all logs (red X) - do not log any information from this category enable normal logs (green checkmark) - log regular information and alerts from this category enable normal logs and debug logs (yellow check mark) - log regular information, alerts, and debugging information from this category
OK	Click this to save your changes and return to the previous screen.
Cancel	Click this to return to the previous screen without saving your changes.

17.2.3 Active Log Summary

This screen allows you to view and to edit what information is included in the system log and remote servers at the same time. It does not let you change other log settings. To access this screen, go to the **Log Setting** screen, and click the **Active Log Summary** button.

Figure 153 Active Log Summary

The screenshot shows a window titled "Active Log Summary" with a toolbar at the top containing "System Log", "Remote Server 1", "Remote Server 2", "Remote Server 3", and "Remote Server 4". Below the toolbar is a table with the following columns: "Log Category", "System Log", "Remote Server 1", "Remote Server 2", "Remote Server 3", and "Remote Server 4". Each cell in the table contains three radio buttons (one selected) or three checkboxes (all checked). The table lists 34 log categories, with the "Default" category at row 8. At the bottom of the window, there is a pagination bar showing "Page 1 of 1" and "Show 50 items", and a status bar indicating "Displaying 1 - 34 of 34".

#	Log Category	System Log	Remote Server 1	Remote Server 2	Remote Server 3	Remote Server 4
1	Account	<input type="radio"/> <input checked="" type="radio"/> <input type="radio"/>	<input checked="" type="radio"/> <input type="radio"/> <input type="radio"/>	<input checked="" type="radio"/> <input type="radio"/> <input type="radio"/>	<input checked="" type="radio"/> <input type="radio"/> <input type="radio"/>	<input checked="" type="radio"/> <input type="radio"/> <input type="radio"/>
2	Authentication Server	<input type="radio"/> <input checked="" type="radio"/> <input type="radio"/>	<input checked="" type="radio"/> <input type="radio"/> <input type="radio"/>	<input checked="" type="radio"/> <input type="radio"/> <input type="radio"/>	<input checked="" type="radio"/> <input type="radio"/> <input type="radio"/>	<input checked="" type="radio"/> <input type="radio"/> <input type="radio"/>
3	Bluetooth	<input type="radio"/> <input checked="" type="radio"/> <input type="radio"/>	<input checked="" type="radio"/> <input type="radio"/> <input type="radio"/>	<input checked="" type="radio"/> <input type="radio"/> <input type="radio"/>	<input checked="" type="radio"/> <input type="radio"/> <input type="radio"/>	<input checked="" type="radio"/> <input type="radio"/> <input type="radio"/>
4	Built-in Service	<input type="radio"/> <input checked="" type="radio"/> <input type="radio"/>	<input checked="" type="radio"/> <input type="radio"/> <input type="radio"/>	<input checked="" type="radio"/> <input type="radio"/> <input type="radio"/>	<input checked="" type="radio"/> <input type="radio"/> <input type="radio"/>	<input checked="" type="radio"/> <input type="radio"/> <input type="radio"/>
5	Cloud Auth	<input type="radio"/> <input checked="" type="radio"/> <input type="radio"/>	<input checked="" type="radio"/> <input type="radio"/> <input type="radio"/>	<input checked="" type="radio"/> <input type="radio"/> <input type="radio"/>	<input checked="" type="radio"/> <input type="radio"/> <input type="radio"/>	<input checked="" type="radio"/> <input type="radio"/> <input type="radio"/>
6	Connectivity Check	<input type="radio"/> <input checked="" type="radio"/> <input type="radio"/>	<input checked="" type="radio"/> <input type="radio"/> <input type="radio"/>	<input checked="" type="radio"/> <input type="radio"/> <input type="radio"/>	<input checked="" type="radio"/> <input type="radio"/> <input type="radio"/>	<input checked="" type="radio"/> <input type="radio"/> <input type="radio"/>
7	Daily Report	<input type="radio"/> <input checked="" type="radio"/> <input type="radio"/>	<input checked="" type="radio"/> <input type="radio"/> <input type="radio"/>	<input checked="" type="radio"/> <input type="radio"/> <input type="radio"/>	<input checked="" type="radio"/> <input type="radio"/> <input type="radio"/>	<input checked="" type="radio"/> <input type="radio"/> <input type="radio"/>
8	Default	<input type="radio"/> <input checked="" type="radio"/> <input type="radio"/>	<input checked="" type="radio"/> <input type="radio"/> <input type="radio"/>	<input checked="" type="radio"/> <input type="radio"/> <input type="radio"/>	<input checked="" type="radio"/> <input type="radio"/> <input type="radio"/>	<input checked="" type="radio"/> <input type="radio"/> <input type="radio"/>
9	Device HA	<input type="radio"/> <input checked="" type="radio"/> <input type="radio"/>	<input checked="" type="radio"/> <input type="radio"/> <input type="radio"/>	<input checked="" type="radio"/> <input type="radio"/> <input type="radio"/>	<input checked="" type="radio"/> <input type="radio"/> <input type="radio"/>	<input checked="" type="radio"/> <input type="radio"/> <input type="radio"/>
10	Dynamic Frequency ...	<input type="radio"/> <input checked="" type="radio"/> <input type="radio"/>	<input checked="" type="radio"/> <input type="radio"/> <input type="radio"/>	<input checked="" type="radio"/> <input type="radio"/> <input type="radio"/>	<input checked="" type="radio"/> <input type="radio"/> <input type="radio"/>	<input checked="" type="radio"/> <input type="radio"/> <input type="radio"/>
11	DHCP	<input type="radio"/> <input checked="" type="radio"/> <input type="radio"/>	<input checked="" type="radio"/> <input type="radio"/> <input type="radio"/>	<input checked="" type="radio"/> <input type="radio"/> <input type="radio"/>	<input checked="" type="radio"/> <input type="radio"/> <input type="radio"/>	<input checked="" type="radio"/> <input type="radio"/> <input type="radio"/>
12	File Manager	<input type="radio"/> <input checked="" type="radio"/> <input type="radio"/>	<input checked="" type="radio"/> <input type="radio"/> <input type="radio"/>	<input checked="" type="radio"/> <input type="radio"/> <input type="radio"/>	<input checked="" type="radio"/> <input type="radio"/> <input type="radio"/>	<input checked="" type="radio"/> <input type="radio"/> <input type="radio"/>
13	Force Authentication	<input type="radio"/> <input checked="" type="radio"/> <input type="radio"/>	<input checked="" type="radio"/> <input type="radio"/> <input type="radio"/>	<input checked="" type="radio"/> <input type="radio"/> <input type="radio"/>	<input checked="" type="radio"/> <input type="radio"/> <input type="radio"/>	<input checked="" type="radio"/> <input type="radio"/> <input type="radio"/>
14	Interface	<input type="radio"/> <input checked="" type="radio"/> <input type="radio"/>	<input checked="" type="radio"/> <input type="radio"/> <input type="radio"/>	<input checked="" type="radio"/> <input type="radio"/> <input type="radio"/>	<input checked="" type="radio"/> <input type="radio"/> <input type="radio"/>	<input checked="" type="radio"/> <input type="radio"/> <input type="radio"/>
15	Interface Statistics	<input type="radio"/> <input type="radio"/> <input type="radio"/>	<input checked="" type="radio"/> <input type="radio"/> <input type="radio"/>	<input checked="" type="radio"/> <input type="radio"/> <input type="radio"/>	<input checked="" type="radio"/> <input type="radio"/> <input type="radio"/>	<input checked="" type="radio"/> <input type="radio"/> <input type="radio"/>
16	PKI	<input type="radio"/> <input checked="" type="radio"/> <input type="radio"/>	<input checked="" type="radio"/> <input type="radio"/> <input type="radio"/>	<input checked="" type="radio"/> <input type="radio"/> <input type="radio"/>	<input checked="" type="radio"/> <input type="radio"/> <input type="radio"/>	<input checked="" type="radio"/> <input type="radio"/> <input type="radio"/>
17	Real-Time Location S...	<input type="radio"/> <input checked="" type="radio"/> <input type="radio"/>	<input checked="" type="radio"/> <input type="radio"/> <input type="radio"/>	<input checked="" type="radio"/> <input type="radio"/> <input type="radio"/>	<input checked="" type="radio"/> <input type="radio"/> <input type="radio"/>	<input checked="" type="radio"/> <input type="radio"/> <input type="radio"/>
18	Smart Mesh	<input type="radio"/> <input checked="" type="radio"/> <input type="radio"/>	<input checked="" type="radio"/> <input type="radio"/> <input type="radio"/>	<input checked="" type="radio"/> <input type="radio"/> <input type="radio"/>	<input checked="" type="radio"/> <input type="radio"/> <input type="radio"/>	<input checked="" type="radio"/> <input type="radio"/> <input type="radio"/>
19	sta roaming	<input type="radio"/> <input checked="" type="radio"/> <input type="radio"/>	<input checked="" type="radio"/> <input type="radio"/> <input type="radio"/>	<input checked="" type="radio"/> <input type="radio"/> <input type="radio"/>	<input checked="" type="radio"/> <input type="radio"/> <input type="radio"/>	<input checked="" type="radio"/> <input type="radio"/> <input type="radio"/>
20	Station Info Collection	<input type="radio"/> <input type="radio"/> <input type="radio"/>	<input checked="" type="radio"/> <input type="radio"/> <input type="radio"/>	<input checked="" type="radio"/> <input type="radio"/> <input type="radio"/>	<input checked="" type="radio"/> <input type="radio"/> <input type="radio"/>	<input checked="" type="radio"/> <input type="radio"/> <input type="radio"/>
21	System	<input type="radio"/> <input checked="" type="radio"/> <input type="radio"/>	<input checked="" type="radio"/> <input type="radio"/> <input type="radio"/>	<input checked="" type="radio"/> <input type="radio"/> <input type="radio"/>	<input checked="" type="radio"/> <input type="radio"/> <input type="radio"/>	<input checked="" type="radio"/> <input type="radio"/> <input type="radio"/>
22	System Monitoring	<input type="radio"/> <input type="radio"/> <input type="radio"/>	<input checked="" type="radio"/> <input type="radio"/> <input type="radio"/>	<input checked="" type="radio"/> <input type="radio"/> <input type="radio"/>	<input checked="" type="radio"/> <input type="radio"/> <input type="radio"/>	<input checked="" type="radio"/> <input type="radio"/> <input type="radio"/>
23	Traffic Log	<input type="radio"/> <input type="radio"/> <input type="radio"/>	<input checked="" type="radio"/> <input type="radio"/> <input type="radio"/>	<input checked="" type="radio"/> <input type="radio"/> <input type="radio"/>	<input checked="" type="radio"/> <input type="radio"/> <input type="radio"/>	<input checked="" type="radio"/> <input type="radio"/> <input type="radio"/>
24	User	<input type="radio"/> <input checked="" type="radio"/> <input type="radio"/>	<input checked="" type="radio"/> <input type="radio"/> <input type="radio"/>	<input checked="" type="radio"/> <input type="radio"/> <input type="radio"/>	<input checked="" type="radio"/> <input type="radio"/> <input type="radio"/>	<input checked="" type="radio"/> <input type="radio"/> <input type="radio"/>
25	Wireless Health	<input type="radio"/> <input checked="" type="radio"/> <input type="radio"/>	<input checked="" type="radio"/> <input type="radio"/> <input type="radio"/>	<input checked="" type="radio"/> <input type="radio"/> <input type="radio"/>	<input checked="" type="radio"/> <input type="radio"/> <input type="radio"/>	<input checked="" type="radio"/> <input type="radio"/> <input type="radio"/>
26	Wireless LAN	<input type="radio"/> <input checked="" type="radio"/> <input type="radio"/>	<input checked="" type="radio"/> <input type="radio"/> <input type="radio"/>	<input checked="" type="radio"/> <input type="radio"/> <input type="radio"/>	<input checked="" type="radio"/> <input type="radio"/> <input type="radio"/>	<input checked="" type="radio"/> <input type="radio"/> <input type="radio"/>
27	WLAN Band Select	<input type="radio"/> <input type="radio"/> <input type="radio"/>	<input checked="" type="radio"/> <input type="radio"/> <input type="radio"/>	<input checked="" type="radio"/> <input type="radio"/> <input type="radio"/>	<input checked="" type="radio"/> <input type="radio"/> <input type="radio"/>	<input checked="" type="radio"/> <input type="radio"/> <input type="radio"/>
28	WLAN Dynamic Cha...	<input type="radio"/> <input checked="" type="radio"/> <input type="radio"/>	<input checked="" type="radio"/> <input type="radio"/> <input type="radio"/>	<input checked="" type="radio"/> <input type="radio"/> <input type="radio"/>	<input checked="" type="radio"/> <input type="radio"/> <input type="radio"/>	<input checked="" type="radio"/> <input type="radio"/> <input type="radio"/>
29	AP Load Balancing	<input type="radio"/> <input checked="" type="radio"/> <input type="radio"/>	<input checked="" type="radio"/> <input type="radio"/> <input type="radio"/>	<input checked="" type="radio"/> <input type="radio"/> <input type="radio"/>	<input checked="" type="radio"/> <input type="radio"/> <input type="radio"/>	<input checked="" type="radio"/> <input type="radio"/> <input type="radio"/>
30	WLAN Rogue AP Det...	<input type="radio"/> <input checked="" type="radio"/> <input type="radio"/>	<input checked="" type="radio"/> <input type="radio"/> <input type="radio"/>	<input checked="" type="radio"/> <input type="radio"/> <input type="radio"/>	<input checked="" type="radio"/> <input type="radio"/> <input type="radio"/>	<input checked="" type="radio"/> <input type="radio"/> <input type="radio"/>
31	Wlan Station Info	<input type="radio"/> <input checked="" type="radio"/> <input type="radio"/>	<input checked="" type="radio"/> <input type="radio"/> <input type="radio"/>	<input checked="" type="radio"/> <input type="radio"/> <input type="radio"/>	<input checked="" type="radio"/> <input type="radio"/> <input type="radio"/>	<input checked="" type="radio"/> <input type="radio"/> <input type="radio"/>
32	Zyxel One Network	<input type="radio"/> <input type="radio"/> <input type="radio"/>	<input checked="" type="radio"/> <input type="radio"/> <input type="radio"/>	<input checked="" type="radio"/> <input type="radio"/> <input type="radio"/>	<input checked="" type="radio"/> <input type="radio"/> <input type="radio"/>	<input checked="" type="radio"/> <input type="radio"/> <input type="radio"/>
33	ZyMesh	<input type="radio"/> <input checked="" type="radio"/> <input type="radio"/>	<input checked="" type="radio"/> <input type="radio"/> <input type="radio"/>	<input checked="" type="radio"/> <input type="radio"/> <input type="radio"/>	<input checked="" type="radio"/> <input type="radio"/> <input type="radio"/>	<input checked="" type="radio"/> <input type="radio"/> <input type="radio"/>
34	ZySH	<input type="radio"/> <input checked="" type="radio"/> <input type="radio"/>	<input checked="" type="radio"/> <input type="radio"/> <input type="radio"/>	<input checked="" type="radio"/> <input type="radio"/> <input type="radio"/>	<input checked="" type="radio"/> <input type="radio"/> <input type="radio"/>	<input checked="" type="radio"/> <input type="radio"/> <input type="radio"/>

This screen provides a different view and a different way of indicating which messages are included in each log and each alert. (The **Default** category includes debugging messages generated by open source software.)

The following table describes the fields in this screen.

Table 97 Configuration > Log & Report > Log Setting > Active Log Summary

LABEL	DESCRIPTION
Active Log Summary	If the Zyxel Device is set to controller mode, the AC section controls logs generated by the controller and the AP section controls logs generated by the managed APs.
System log	<p>Use the System Log drop-down list to change the log settings for all of the log categories.</p> <p>disable all logs (red X) - do not log any information for any category for the system log or email any logs to email server 1 or 2.</p> <p>enable normal logs (green check mark) - create log messages and alerts for all categories for the system log. If email server 1 or 2 also has normal logs enabled, the Zyxel Device will email logs to them.</p> <p>enable normal logs and debug logs (yellow check mark) - create log messages, alerts, and debugging information for all categories. The Zyxel Device does not email debugging information, even if this setting is selected.</p>
Remote Server 1~4	<p>For each remote server, use the Selection drop-down list to change the log settings for all of the log categories.</p> <p>disable all logs (red X) - do not send the remote server logs for any log category.</p> <p>enable normal logs (green check mark) - send the remote server log messages and alerts for all log categories.</p> <p>enable normal logs and debug logs (yellow check mark) - send the remote server log messages, alerts, and debugging information for all log categories.</p>
#	This field is a sequential value, and it is not associated with a specific address.
Log Category	This field displays each category of messages. It is the same value used in the Display and Category fields in the View Log tab. The Default category includes debugging messages generated by open source software.
System log	<p>Select which events you want to log by Log Category. There are three choices:</p> <p>disable all logs (red X) - do not log any information from this category</p> <p>enable normal logs (green checkmark) - create log messages and alerts from this category</p> <p>enable normal logs and debug logs (yellow check mark) - create log messages, alerts, and debugging information from this category; the Zyxel Device does not email debugging information, however, even if this setting is selected.</p>
Remote Server 1~4 Syslog	<p>For each remote server, select what information you want to log from each Log Category (except All Logs; see below). Choices are:</p> <p>disable all logs (red X) - do not log any information from this category</p> <p>enable normal logs (green checkmark) - log regular information and alerts from this category</p> <p>enable normal logs and debug logs (yellow check mark) - log regular information, alerts, and debugging information from this category</p>
OK	Click this to save your changes and return to the previous screen.
Cancel	Click this to return to the previous screen without saving your changes.

CHAPTER 18

File Manager

18.1 Overview

Configuration files define the Zyxel Device's settings. Shell scripts are files of commands that you can store on the Zyxel Device and run when you need them. You can apply a configuration file or run a shell script without the Zyxel Device restarting. You can store multiple configuration files and shell script files on the Zyxel Device. You can edit configuration files or shell scripts in a text editor and upload them to the Zyxel Device. Configuration files use a .conf extension and shell scripts use a .zysh extension.

18.1.1 What You Can Do in this Chapter

- The **Configuration File** screen ([Configuration File](#)) stores and names configuration files. You can also download and upload configuration files.
- The **Firmware Package** screen ([Firmware Package](#)) checks your current firmware version and uploads firmware to the Zyxel Device.
- The **Shell Script** screen ([Shell Script](#)) stores, names, downloads, uploads and runs shell script files.

18.1.2 What you Need to Know

The following terms and concepts may help as you read this chapter.

Configuration Files and Shell Scripts

When you apply a configuration file, the Zyxel Device uses the factory default settings for any features that the configuration file does not include. When you run a shell script, the Zyxel Device only applies the commands that it contains. Other settings do not change.

These files have the same syntax, which is also identical to the way you run CLI commands manually. An example is shown below.

Figure 154 Configuration File / Shell Script: Example

```
# enter configuration mode
configure terminal
# change administrator password
username admin password 4321 user-type admin
#configure default radio profile, change 2GHz channel to 11 & Tx output
power # to 50%
wlan-radio-profile default
2g-channel 11
output-power 50%
exit
write
```

While configuration files and shell scripts have the same syntax, the Zyxel Device applies configuration files differently than it runs shell scripts. This is explained below.

Table 98 Configuration Files and Shell Scripts in the Zyxel Device

Configuration Files (.conf)	Shell Scripts (.zysh)
<ul style="list-style-type: none"> Resets to default configuration. Goes into CLI Configuration mode. Runs the commands in the configuration file. 	<ul style="list-style-type: none"> Goes into CLI Privilege mode. Runs the commands in the shell script.

You have to run the aforementioned example as a shell script because the first command is run in **Privilege** mode. If you remove the first command, you have to run the example as a configuration file because the rest of the commands are executed in **Configuration** mode.

Errors in Configuration Files or Shell Scripts

When you apply a configuration file or run a shell script, the Zyxel Device processes the file line-by-line. The Zyxel Device checks the first line and applies the line if no errors are detected. Then it continues with the next line. If the Zyxel Device finds an error, it stops applying the configuration file or shell script and generates a log.

You can change the way a configuration file or shell script is applied. Include `setenv stop-on-error off` in the configuration file or shell script. The Zyxel Device ignores any errors in the configuration file or shell script and applies all of the valid commands. The Zyxel Device still generates a log for any errors.

Sub commands in Configuration Files or Shell Scripts

In a configuration file or shell script, sub commands are used to further define commands.

In the following example, the commands change the SSID name to "Alice-AP" on the Zyxel Device:

```
configure terminal
wlan-ssid-profile default
ssid Joe-AP
exit
write
```

- Line 1: Enter **Configuration** mode: `configure terminal`
- Line 2: Enter SSID profile (and enter sub command mode): `wlan-ssid-profile default`
- Line 3: Configure the SSID name: `ssid Joe-AP`
- Line 4: Exit sub command mode: `exit`
- Line 5: Save the configuration: `write`

Your configuration files or shell scripts can use "exit" or a command line consisting of a single "!" to have the Zyxel Device exit sub command mode.

Note: "exit" or "!" must follow sub commands if it is to make the Zyxel Device exit sub command mode.

Sensitive Data Protection

The Zyxel Device by default encrypts local admin and user account passwords for web configurator and CLI.

Enable **Sensitive Data Protection** to have the Zyxel Device use a private key to encrypt local admin and user account passwords for web configurator and CLI.

Note: You can only upload configuration files using FTP that are using the current private key of the Zyxel Device.

The following examples describe the situations you might come across using **Sensitive Data Protection**.

Example 1:

- 1 Download a configuration file (file1).
- 2 Enable **Sensitive Data Protection**.
- 3 Create a private key (key1).
- 4 When you upload file1 to the Zyxel Device through the Zyxel Device web configurator, you do not need to enter the private key (key1). Configuration file1 is not encrypted by the private key (key1).

Example 2:

- 1 Enable **Sensitive Data Protection**.
- 2 Create a private key (key1).
- 3 Download a configuration file (file2).
- 4 You must use key1 to upload file2 to the Zyxel Device because file2 is encrypted by key1.

Example 3:

- 1 Change the private key from key1 to key2.
- 2 Download another configuration file (file3).
- 3 You must use key2 to upload file3 to the Zyxel Device.

Note: You must still use key1 to upload file2 to the Zyxel Device. Make a note of the key to use when you change the private key and then download a configuration file.

Example 4:

- 1 Enable **Sensitive Data Protection** on Zyxel Device1 and create a private key.
- 2 Download a configuration file from Zyxel Device1.
- 3 You must upload this configuration file using the private key you created on Zyxel Device1 to Zyxel Device2 even if **Sensitive Data Protection** is not enabled on Zyxel Device2.

18.2 Configuration File

Click **Maintenance > File Manager > Configuration File** to open this screen. Use the **Configuration File** screen to store, run, and name configuration files. You can also download configuration files from the Zyxel Device to your computer and upload configuration files from your computer to the Zyxel Device.

Once your Zyxel Device is configured and functioning properly, it is highly recommended that you back up your configuration file before making further configuration changes. The backup configuration file will be useful in case you need to return to your previous settings.

Configuration File Flow at Restart

- If there is not a **startup-config.conf** when you restart the Zyxel Device (whether through a management interface or by physically turning the power off and back on), the Zyxel Device uses the **system-default.conf** configuration file with the Zyxel Device's default settings.
- If there is a **startup-config.conf**, the Zyxel Device checks it for errors and applies it. If there are no errors, the Zyxel Device uses it and copies it to the **lastgood.conf** configuration file as a back up file. If there is an error, the Zyxel Device generates a log and copies the **startup-config.conf** configuration file to the **startup-config-bad.conf** configuration file and tries the existing **lastgood.conf** configuration file. If there isn't a **lastgood.conf** configuration file or it also has an error, the Zyxel Device applies the **system-default.conf** configuration file.
- You can change the way the **startup-config.conf** file is applied. Include the `setenv-startup stop-on-error off` command. The Zyxel Device ignores any errors in the **startup-config.conf** file and applies all of the valid commands. The Zyxel Device still generates a log for any errors.

Figure 155 Maintenance > File Manager > Configuration File

The screenshot displays the 'Configuration File' management interface. At the top, there are three tabs: 'Configuration File' (selected), 'Firmware Package', and 'Shell Script'. Below the tabs, the 'Configuration Files' section contains a table with the following data:

#	File Name	Size	Last Modified
1	startup-config.conf	4820	2023-04-07 01:49:13
2	system-default.conf	4263	2023-04-07 01:46:36
3	lastgood.conf	4820	2023-04-07 01:47:03

Below the table, there is a 'Sensitive Data Protection' section with the text: 'The Private Encryption Key provides extra protection for the local user's password stored on the Zyxel Device.' and an 'Enable' checkbox. At the bottom, the 'Upload Configuration File' section includes the instruction: 'To upload a configuration file, browse to the location of the file (.conf) and then click Upload.' and a file selection field with 'Browse...' and 'Upload' buttons. An 'Apply' button is located at the bottom center of the interface.

Do not turn off the Zyxel Device while configuration file upload is in progress.

The following table describes the labels in this screen.

Table 99 Maintenance > File Manager > Configuration File

LABEL	DESCRIPTION
Configuration Files	
Rename	<p>Use this button to change the label of a configuration file on the Zyxel Device. You can only rename manually saved configuration files. You cannot rename the lastgood.conf, system-default.conf and startup-config.conf files.</p> <p>You cannot rename a configuration file to the name of another configuration file in the Zyxel Device.</p> <p>Click a configuration file's row to select it and click Rename to open the Rename File screen.</p>  <p>Specify the new name for the configuration file. Use up to 25 characters (including a-zA-Z0-9;~!@#\$\$%^&()_+[]{}',.-).</p> <p>Click OK to save the duplicate or click Cancel to close the screen without saving a duplicate of the configuration file.</p>
Remove	<p>Click a configuration file's row to select it and click Remove to delete it from the Zyxel Device. You can only delete manually saved configuration files. You cannot delete the system-default.conf, startup-config.conf and lastgood.conf files.</p> <p>A pop-up window asks you to confirm that you want to delete the configuration file. Click OK to delete the configuration file or click Cancel to close the screen without deleting the configuration file.</p>
Download	<p>Click a configuration file's row to select it and click Download to save the configuration to your computer.</p>
Copy	<p>Use this button to save a duplicate of a configuration file on the Zyxel Device.</p> <p>Click a configuration file's row to select it and click Copy to open the Copy File screen.</p>  <p>Specify a name for the duplicate configuration file. Use up to 25 characters (including a-zA-Z0-9;~!@#\$\$%^&()_+[]{}',.-).</p> <p>Click OK to save the duplicate or click Cancel to close the screen without saving a duplicate of the configuration file.</p>

Table 99 Maintenance > File Manager > Configuration File (continued)



LABEL	DESCRIPTION
Apply	<p>Use this button to have the Zyxel Device use a specific configuration file.</p> <p>Click a configuration file's row to select it and click Apply to have the Zyxel Device use that configuration file. The Zyxel Device does not have to restart in order to use a different configuration file, although you will need to wait for a few minutes while the system reconfigures.</p> <p>The following screen gives you options for what the Zyxel Device is to do if it encounters an error in the configuration file.</p>  <p>Immediately stop applying the configuration file - this is not recommended because it would leave the rest of the configuration blank. If the interfaces were not configured before the first error, the console port may be the only way to access the Zyxel Device.</p> <p>Immediately stop applying the configuration file and roll back to the previous configuration - this gets the Zyxel Device started with a fully valid configuration file as quickly as possible.</p> <p>Ignore errors and finish applying the configuration file - this applies the valid parts of the configuration file and generates error logs for all of the configuration file's errors. This lets the Zyxel Device apply most of your configuration and you can refer to the logs for what to fix.</p> <p>Ignore errors and finish applying the configuration file and then roll back to the previous configuration - this applies the valid parts of the configuration file, generates error logs for all of the configuration file's errors, and starts the Zyxel Device with a fully valid configuration file.</p> <p>Click OK to have the Zyxel Device start applying the configuration file or click Cancel to close the screen.</p>
#	<p>This column displays the number for each configuration file entry. This field is a sequential value, and it is not associated with a specific address. The total number of configuration files that you can save depends on the sizes of the configuration files and the available flash storage space.</p>
File Name	<p>This column displays the label that identifies a configuration file.</p> <p>You cannot delete the following configuration files or change their file names.</p> <p>The system-default.conf file contains the Zyxel Device's default settings. Select this file and click Apply to reset all of the Zyxel Device settings to the factory defaults. This configuration file is included when you upload a firmware package.</p> <p>The startup-config.conf file is the configuration file that the Zyxel Device is currently using. If you make and save changes during your management session, the changes are applied to this configuration file. The Zyxel Device applies configuration changes made in the Web Configurator to the configuration file when you click Apply or OK. It applies configuration changes made through CLI commands when you use the <code>write</code> command.</p> <p>The lastgood.conf is the most recently used (valid) configuration file that was saved when the Zyxel Device last restarted. If you upload and apply a configuration file with an error, you can apply lastgood.conf to return to a valid configuration.</p>
Size	<p>This column displays the size (in KB) of a configuration file.</p>

Table 99 Maintenance > File Manager > Configuration File (continued)

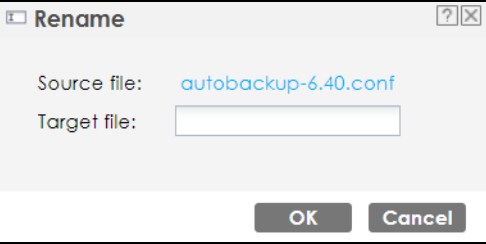
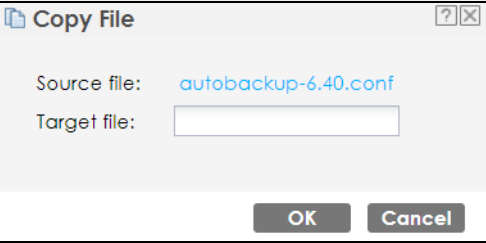
LABEL	DESCRIPTION
Last Modified	This column displays the date and time that the individual configuration files were last changed or saved.
Sensitive Data Protection	
Enable	<p>Select this to enable Sensitive Data Protection; see Overview for more information.</p> <p>You need this key to upload configuration files. Write down the key you set and keep it in a safe place.</p> <p>Figure 156 Upload Configuration File</p> 
Enter Private Encryption Key	Enter the encryption key in this field. The encryption key should be 4-8 single byte printable characters, including 0-9a-zA-Z`~!@#\$%^&*()_+={} ~;<.>./].
Re-enter Private Encryption Key	Enter the encryption key again in this field.
	<p>Upload Configuration File</p> <p>The bottom part of the screen allows you to upload a new or previously saved configuration file from your computer to your Zyxel Device.</p> <p>You cannot upload a configuration file named system-default.conf or lastgood.conf.</p> <p>If you upload startup-config.conf, it will replace the current configuration and immediately apply the new settings.</p>
File	Type in the location of the file you want to upload in this field or click Browse... to find it.
Browse...	Click Browse... to find the .conf file you want to upload. The configuration file must use a ".conf" filename extension. You will receive an error message if you try to upload a file of a different format. Remember that you must decompress compressed (.zip) files before you can upload them.
Upload	Click Upload to begin the upload process. This process may take up to two minutes.
Apply	Click Apply to save your changes back to the Zyxel Device.

18.2.1 Example of Configuration File Download Using FTP

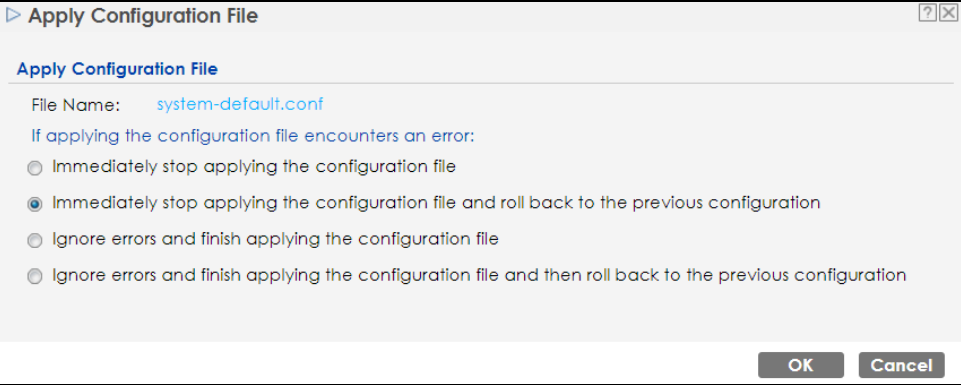
The following example gets a configuration file named startup-config.conf from the Zyxel Device and saves it on the computer.

- 1 Connect your computer to the Zyxel Device.
- 2 The FTP server IP address of the Zyxel Device in standalone mode is 192.168.1.2, so set your computer to use a static IP address from 192.168.1.3 ~192.168.1.254.

- 3 Use an FTP client on your computer to connect to the Zyxel Device. For example, in the Windows command prompt, type `ftp 192.168.1.2`. Keep the console session connected in order to see when the firmware recovery finishes.
- 4 Enter your user name when prompted.
- 5 Enter your password as requested.
- 6 Use "cd" to change to the directory that contains the files you want to download.
- 7 Use "dir" or "ls" if you need to display a list of the files in the directory.
- 8 Use "get" to download files. Transfer the configuration file on the Zyxel Device to your computer. Type `get` followed by the name of the configuration file. This examples uses `get startup-config.conf`.

```
C:\>ftp 192.168.1.2
Connected to 192.168.1.2.
220----- Welcome to Pure-FTPd [privsep] [TLS] -----
220-You are user number 1 of 5 allowed.
220-Local time is now 21:28. Server port: 21.
220-This is a private system - No anonymous login
220 You will be disconnected after 600 minutes of inactivity.
User (192.168.1.2:(none)): admin
331 User admin OK. Password required
Password:
230 OK. Current restricted directory is /
ftp> cd conf
250 OK. Current directory is /conf
ftp> ls
200 PORT command successful
150 Connecting to port 5001
lastgood.conf
startup-config.conf
system-default.conf
226 3 matches total
ftp: 57 bytes received in 0.33Seconds 0.17Kbytes/sec.
ftp> get startup-config.conf
200 PORT command successful
150 Connecting to port 5002
226-File successfully transferred
226 0.002 seconds (measured here), 1.66 Mbytes per second
ftp: 2928 bytes received in 0.02Seconds 183.00Kbytes/sec.
ftp>
```

- 9 Wait for the file transfer to complete.
- 10 Enter "quit" to exit the ftp prompt.

18.3 Firmware Package

Click **Maintenance > File Manager > Firmware Package** to open this screen. Use the **Firmware Package** screen to check your current firmware version and upload firmware to the Zyxel Device.

Note: The Web Configurator is the recommended method for uploading firmware. You only need to use the command line interface if you need to recover the firmware. See the CLI Reference Guide for how to determine if you need to recover the firmware and how to recover it.

You can manually download the new firmware from the Zyxel website, or you can click **Check Now** to automatically find the latest firmware for your Zyxel Device (recommended).

The firmware update can take up to five minutes. Do not turn off or reset the Zyxel Device while the firmware update is in progress!

Figure 157 Maintenance > File Manager > Firmware Package

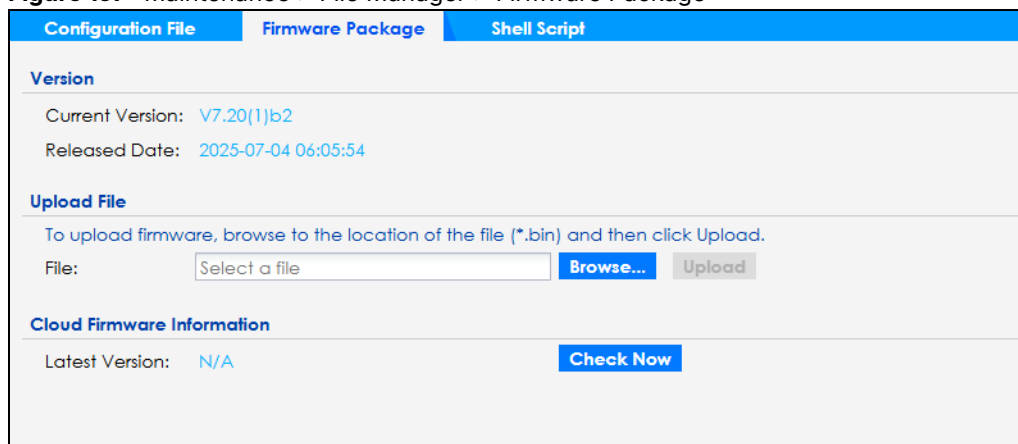
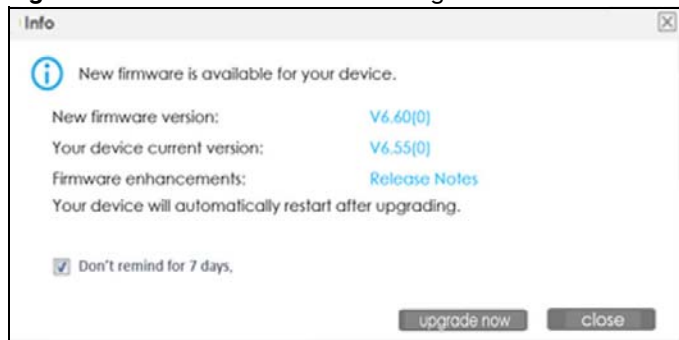

Figure 158 Maintenance > File Manager > Firmware Package > Check now



The following table describes the labels in this screen.

Table 100 Maintenance > File Manager > Firmware Package

LABEL	DESCRIPTION
Current Version	This is the firmware version and the date created.
Released Date	This is the date that the version of the firmware was created.
File Path	Type in the location of the file you want to upload in this field or click Browse... to find it.
Browse...	Click Browse... to find the .bin file you want to upload. Remember that you must decompress compressed (.zip) files before you can upload them.
Upload	Click Upload to begin the upload process. This process may take up to two minutes.
Check now	Click Check now to view the firmware information. The following message appears when there is a new firmware version available for your Zyxel Device.

Table 100 Maintenance > File Manager > Firmware Package (continued)

LABEL	DESCRIPTION
New firmware version	This is the new firmware version available for your Zyxel Device. V6.60 is the firmware trunk version and the number in brackets is the release number. 0 is the first release of this version firmware. 1 is the next update release of this version firmware.
Your device current version	This is the current firmware version of your Zyxel Device.
Firmware enhancements	Click Release Notes to view the firmware release information of the new firmware, including new features, enhancements and bug fix.
Don't remind for 7 days	Select this to stop receiving this notification for the next 7 days.
upgrade now	Click this to start upgrading your Zyxel Device to the new firmware version.
close	Click this to exit this screen without upgrading your Zyxel Device to the new firmware version.
	The following message appears when the Zyxel Device is checking the latest firmware version available on the cloud server. If it is later than your current firmware version on the Zyxel Device, you will be prompted to download it. 

Firmware Download Failed

The following pop-up messages display the causes and solutions for firmware download failure.

Firmware download failed due to an Internet error. Refer to [Internet Access](#) for more information.

Figure 159 Firmware Download Failed. Check Internet Access.



Firmware download failed due to a DNS problem. Please check your device's DNS settings.

Figure 160 Firmware Download failed. Check DNS Settings.

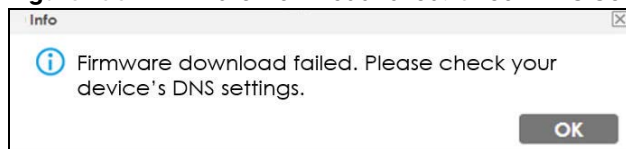

Firmware download failed. Download the new firmware manually from the Zyxel website. Then, go to the **Maintenance > File Manager > Firmware Package** screen to upload the new firmware.

Figure 161 Firmware Download Failed. Download Manually.

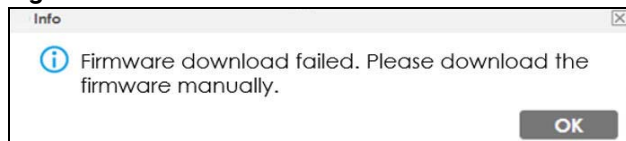

After you see the **Firmware Upload in Process** screen, wait two minutes before logging into the Zyxel Device again.

Note: The Zyxel Device automatically reboots after a successful upload.

The Zyxel Device automatically restarts causing a temporary network disconnect to devices connected to its network. In some operating systems, you may see the following icon on your desktop.

Figure 162 Network Temporarily Disconnected

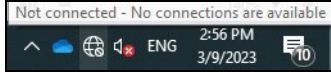

After five minutes, log in again and check your new firmware version in the **Dashboard** screen.

18.3.1 Example of Firmware Upload Using FTP

This procedure requires the Zyxel Device's firmware. Download the firmware package from www.zyxel.com and unzip it. The firmware file uses a .bin extension, for example, "600ABFH0C0.bin". Do the following after you have obtained the firmware file.

- 1 Connect your computer to the Zyxel Device.
- 2 The FTP server IP address of the Zyxel Device in standalone mode is 192.168.1.2, so set your computer to use a static IP address from 192.168.1.3 - 192.168.1.254.
- 3 Use an FTP client on your computer to connect to the Zyxel Device. For example, in the Windows command prompt, type `ftp 192.168.1.2`. Keep the console session connected in order to see when the firmware recovery finishes.
- 4 Enter your user name when prompted.
- 5 Enter your password as requested.
- 6 Enter "hash" for FTP to print a '#' character for every 1024 bytes of data you upload so that you can watch the file transfer progress.
- 7 Enter "bin" to set the transfer mode to binary.
- 8 Transfer the firmware file from your computer to the Zyxel Device. Type `put` followed by the path and name of the firmware file. This examples uses `put C:\ftproot\Zyxel Device_FW\600ABFH0C0.bin`.

```
C:\>ftp 192.168.1.2
Connected to 192.168.1.2.
220----- Welcome to Pure-FTPd [privsep] [TLS] -----
220-You are user number 1 of 5 allowed.
220-Local time is now 21:28. Server port: 21.
220-This is a private system - No anonymous login
220 You will be disconnected after 600 minutes of inactivity.
User (192.168.1.2:(none)): admin
331 User admin OK. Password required
Password:
230 OK. Current restricted directory is /
ftp> hash
Hash mark printing On ftp: (2048 bytes/hash mark) .
ftp> bin
200 TYPE is now 8-bit binary
ftp> put C:\ftproot\Zyxel Device_FW\600ABFH0C0.bin
```

Note: The Zyxel Device will not upgrade the firmware if the firmware file you upload is incompatible with the Zyxel Device.

- 9 Wait for the file transfer to complete.
- 10 Enter "quit" to exit the ftp prompt.

18.4 Shell Script

Use shell script files to have the Zyxel Device use commands that you specify. Use a text editor to create the shell script files. They must use a ".zysh" filename extension.

Click **Maintenance > File Manager > Shell Script** to open this screen. Use the **Shell Script** screen to store, name, download, upload and run shell script files. You can store multiple shell script files on the Zyxel Device at the same time.

Note: You should include `write` commands in your scripts. If you do not use the `write` command, the changes will be lost when the Zyxel Device restarts. You could use multiple `write` commands in a long script.

Figure 163 Maintenance > File Manager > Shell Script

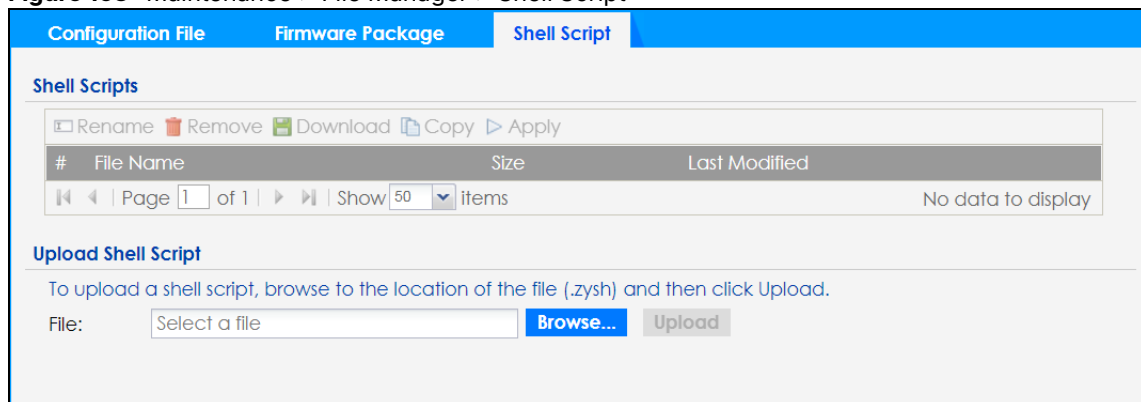

Each field is described in the following table.

Table 101 Maintenance > File Manager > Shell Script

LABEL	DESCRIPTION
Shell Scripts	
Rename	<p>Use this button to change the label of a shell script file on the Zyxel Device.</p> <p>You cannot rename a shell script to the name of another shell script in the Zyxel Device.</p> <p>Click a shell script's row to select it and click Rename to open the Rename File screen.</p> <p>Specify the new name for the shell script file. Use up to 25 characters (including a-zA-Z0-9;~!@#%&()+[]{}',.-).</p> <p>Click OK to save the duplicate or click Cancel to close the screen without saving a duplicate of the configuration file.</p>

Table 101 Maintenance > File Manager > Shell Script (continued)

LABEL	DESCRIPTION
Remove	<p>Click a shell script file's row to select it and click Delete to delete the shell script file from the Zyxel Device.</p> <p>A pop-up window asks you to confirm that you want to delete the shell script file. Click OK to delete the shell script file or click Cancel to close the screen without deleting the shell script file.</p>
Download	<p>Click a shell script file's row to select it and click Download to save the configuration to your computer.</p>
Copy	<p>Use this button to save a duplicate of a shell script file on the Zyxel Device.</p> <p>Click a shell script file's row to select it and click Copy to open the Copy File screen.</p> <p>Specify a name for the duplicate file. Use up to 25 characters (including a-zA-Z0-9;~!@#%&()*+[]{}',=-).</p> <p>Click OK to save the duplicate or click Cancel to close the screen without saving a duplicate of the configuration file.</p>
Apply	<p>Use this button to have the Zyxel Device use a specific shell script file.</p> <p>Click a shell script file's row to select it and click Apply to have the Zyxel Device use that shell script file. You may need to wait awhile for the Zyxel Device to finish applying the commands.</p>
#	<p>This column displays the number for each shell script file entry.</p>
File Name	<p>This column displays the label that identifies a shell script file.</p>
Size	<p>This column displays the size (in KB) of a shell script file.</p>
Last Modified	<p>This column displays the date and time that the individual shell script files were last changed or saved.</p>
<p>Upload Shell Script</p> <p>The bottom part of the screen allows you to upload a new or previously saved shell script file from your computer to your Zyxel Device.</p>	
File	<p>Type in the location of the file you want to upload in this field or click Browse... to find it.</p>
Browse...	<p>Click Browse... to find the .zysh file you want to upload.</p>
Upload	<p>Click Upload to begin the upload process. This process may take up to several minutes.</p>

CHAPTER 19

Legal and Regulatory

19.1 Overview

This screen allows you to view the legal and regulatory information of the Zyxel Device.

19.1.1 What You Can Do In this Chapter

The **Legal and Regulatory** screen ([Legal and Regulatory](#)) allows you to view the legal and regulatory information.

19.2 Legal and Regulatory

Use this screen to view the information on legal and regulatory. This screen may not display depending on the Zyxel Device model you are using.

Figure 164 Maintenance > Legal and Regulatory > Legal and Regulatory

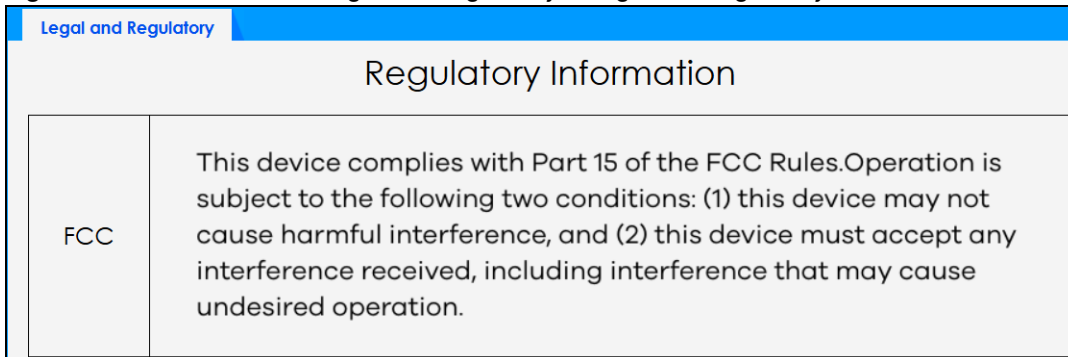

The screenshot shows a web interface with a blue header bar containing the text "Legal and Regulatory". Below the header, the title "Regulatory Information" is centered. A table with one row and two columns is displayed. The first column contains the text "FCC". The second column contains the text: "This device complies with Part 15 of the FCC Rules. Operation is subject to the following two conditions: (1) this device may not cause harmful interference, and (2) this device must accept any interference received, including interference that may cause undesired operation."

Regulatory Information	
FCC	This device complies with Part 15 of the FCC Rules. Operation is subject to the following two conditions: (1) this device may not cause harmful interference, and (2) this device must accept any interference received, including interference that may cause undesired operation.

CHAPTER 20

Diagnostics

20.1 Overview

Use the diagnostics screen for troubleshooting.

20.1.1 What You Can Do in this Chapter

- The **Diagnostics** screen ([Diagnostics](#)) generates a file containing the Zyxel Device's configuration and diagnostic information if you need to provide it to customer support during troubleshooting.
- The **Remote Capture** screen ([Remote Capture](#)) enables remote packet captures on wired or wireless interfaces through an external packet analyzer.

20.2 Diagnostics

This screen provides an easy way for you to generate a file containing the Zyxel Device's configuration and diagnostic information. You may need to generate this file and send it to customer support during troubleshooting. All categories of settings and shell script files stored on the Zyxel Device will be included in the diagnostic file.

Click **Maintenance > Diagnostics > Diagnostics** to open the **Diagnostics** screen. Click **Collect Now** to have the Zyxel Device create a new diagnostic file.

Figure 165 Maintenance > Diagnostics > Diagnostics

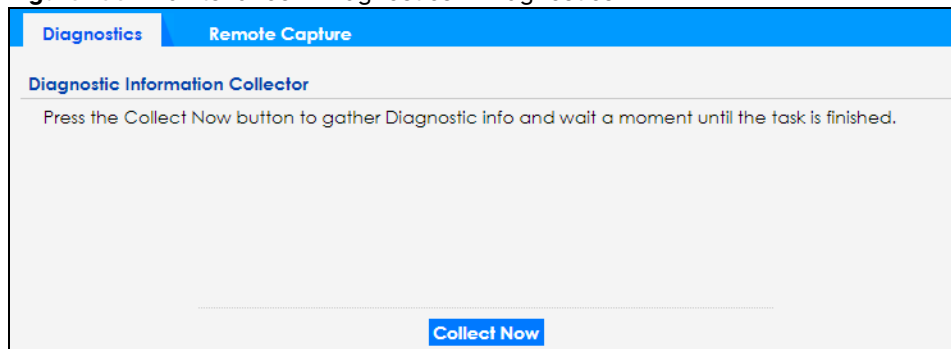

The **Debug Information Collector** screen then displays showing whether the collection is in progress, was successful, or has failed. When the data collection is done, click **Download** to save the most recent diagnostic file to a computer.

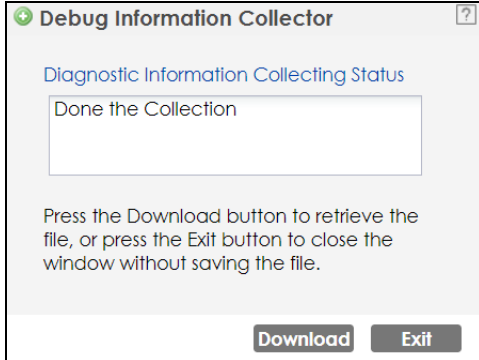
Figure 166 Maintenance > Diagnostics: Debug Information Collector

20.3 Remote Capture

Use this screen to capture network traffic going through the Zyxel Device and output the captured packets to a packet analyzer (also known as network or protocol analyzer) such as Wireshark. If the Zyxel Device is connected to the Zyxel gateway or ZyWALL, you might need to configure the Zyxel gateway or ZyWALL to allow remote capture on the Zyxel Device.

Click **Maintenance > Diagnostics > Remote Capture** to open the **Remote Capture** screen.

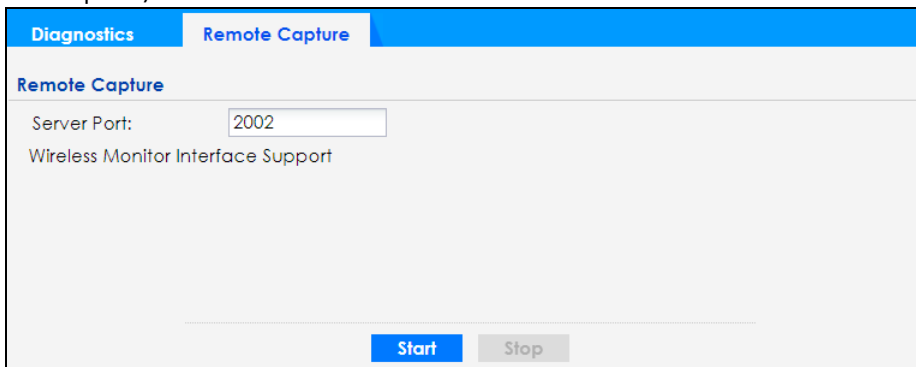
Figure 167 Maintenance > Diagnostics > Remote Capture (Zyxel Device that supports Wireless Remote Capture)

The following table describes the labels in this screen.

Table 102 Maintenance > Diagnostics > Remote Capture

LABEL	DESCRIPTION
Server Port	Enter the number of the server port you want the packet analyzer to connect to in order to capture traffic going through the Zyxel Device. The default port number is 2002.
Start	Click this button to allow the packet analyzer to start capturing traffic going through the Zyxel Device.
Stop	Click this button to stop the packet analyzer from capturing traffic going through the Zyxel Device.

CHAPTER 21

LEDs

21.1 Overview

The LEDs of your Zyxel Device can be controlled such that they stay lit (ON) or OFF after the Zyxel Device is ready. There are two features that control the LEDs of your Zyxel Device – **Locator** and **Suppression**.

Note: Not all Zyxel Devices have LEDs; see [Zyxel Device LED](#) for more information.

21.1.1 What You Can Do in this Chapter

- The **Suppression** screen ([Suppression Screen](#)) allows you to set how you want the LEDs to behave after the Zyxel Device is ready.
- The **Locator** screen ([Locator Screen](#)) allows users to see the actual location of the Zyxel Device between several devices in the network.

21.2 Suppression Screen

The LED Suppression feature allows you to control how the LEDs of your Zyxel Device behave after it is ready. The default LED suppression setting of your AP is different depending on your Zyxel Device model.

You can go to the **Maintenance > LEDs > Suppression** screen to see the default LED behavior and change the LED suppression setting. After you make changes in the suppression screen, it will be stored as the default when the Zyxel Device is restarted. See ([Zyxel Device Product Feature Comparison](#)) for information on default values for different models.

Note: When the Zyxel Device is booting or performing firmware upgrade, the LEDs will light up regardless of the setting in LED suppression.

To access this screen, click **Maintenance > LEDs > Suppression**.

Figure 168 Maintenance > LEDs > Suppression

The screenshot shows a web interface for configuring LED suppression. It features a blue header with 'Suppression' and 'Locator' tabs. The 'Suppression' tab is active, showing a 'Configuration' section with a 'Suppression On' checkbox. Below this is a 'Note' section with a yellow note icon and text explaining exceptions for LED suppression mode. At the bottom of the screen are 'Apply' and 'Reset' buttons.

The following table describes fields in the above screen.

Table 103 Maintenance > LED > Suppression

LABEL	DESCRIPTION
Suppression On	If the Suppression On checkbox is checked, the LEDs of your Zyxel Device will turn off after it's ready. If the checkbox is unchecked, the LEDs will stay lit after the Zyxel Device is ready.
Apply	Click Apply to save your changes back to the Zyxel Device.
Reset	Click Reset to return the screen to its last-saved settings.

21.3 Locator Screen

The Locator feature identifies the location of your Zyxel Device among several devices in the network. You can run this feature and set a timer in this screen.

To run the locator feature, enter a number of minutes and click **Turn On** button to have the Zyxel Device find its location. The Locator LED will start to blink for the number of minutes set in the **Locator** screen. The default setting is 10 minutes. While the locator is running, the turn on button will gray out and return after it's finished. If you make changes to the time default setting, it will be stored as the default when the Zyxel Device restarts.

Note: The Locator feature is not affected by the Suppression setting.

To access this screen, click **Maintenance > LEDs > Locator**.

Figure 169 Maintenance > LEDs > Locator

The screenshot shows a web interface for configuring the Locator feature. At the top, there are two tabs: 'Suppression' and 'Locator', with 'Locator' being the active tab. Below the tabs is a 'Configuration' section. In this section, there are two buttons: 'Turn On' (highlighted in blue) and 'Turn Off' (greyed out). Below these buttons is a text input field labeled 'Automatically Extinguish After:' with the value '10' entered. To the right of the input field is the text '(1-60 minutes)'. At the bottom of the configuration area, there are two buttons: 'Apply' and 'Refresh', both highlighted in blue.

The following table describes fields in the above screen.

Table 104 Maintenance > LED > Locator

LABEL	DESCRIPTION
Turn On / Turn Off	Click Turn On button to activate the locator. The Locator function will show the actual location of the Zyxel Device between several devices in the network. Otherwise, click Turn Off to disable the locator feature.
Automatically Extinguish After	Enter a time interval between 1 and 60 minutes to stop the locator LED from blinking. Default is 10 minutes.
Apply	Click Apply to save changes in this screen.
Refresh	Click Refresh to update the information in this screen.

CHAPTER 22

Reboot

22.1 Overview

Use this screen to restart the Zyxel Device.

22.1.1 What You Need To Know

If you made changes in the Web Configurator, they were saved when you click **Apply**. They do not change when you reboot the Zyxel Device.

If you made changes in the CLI, you have to use the `write` command to save the configuration. They do not change when you reboot the Zyxel Device.

Reboot is different from reset; reset returns the Zyxel Device to its default configuration.

22.2 Reboot

This screen allows remote users to restart the Zyxel Device. To access this screen, click **Maintenance > Reboot**.

You can reboot your Zyxel Device when the Internet connection is slow or intermittent.

Figure 170 Maintenance > Reboot

Reboot

Click the Reboot button to reboot the device. Please wait a few minutes until the login screen appears. If the login screen does not appear, type the IP address of the device in your Web browser.

Maintenance

Enable the schedule

Start Time: 07:30

Week Days: Monday Tuesday Wednesday Thursday
 Friday Saturday Sunday

Apply Reboot Now

Each field is described in the following table.

Table 105 Maintenance > Reboot

LABEL	DESCRIPTION
Maintenance	
Enable the schedule	<p>Select this checkbox to have your Zyxel Device restart at a specific time on selected days of the week.</p> <p>By scheduling a reboot, you can have the Zyxel Device refresh the network connections at a specified time, allowing automatic reconnection with WiFi clients in case of a connection failure.</p>
Start time	Specify the time of the day (in 24-hour format) to have the Zyxel Device automatically restart. For example, 23:00 is 11:00 PM.
Week Days	Select each day of the week to have the automatically restart.
Apply	Click Apply to save your changes to the Zyxel Device.
Reboot Now	Click Reboot Now to restart the Zyxel Device immediately.

After the Zyxel Device reboots, wait a few minutes until the login screen appears. If the login screen does not appear, type the IP address of the Zyxel Device in your Web browser.

You can also use the CLI command `reboot` to restart the Zyxel Device.

PART II

Local Troubleshooting - Cloud Managed Mode

CHAPTER 23

Cloud Managed Mode

23.1 Overview

The Zyxel Device is managed and provisioned automatically by the *NCC (Nebula Control Center)* when it is connected to the Internet and has been registered with the NCC.

If you cannot access the Zyxel Device from the NCC, you need to access the local GUI screens in cloud managed mode by connecting directly to the LAN port of the Zyxel Device, and check if the Zyxel Device's VLAN setting or IP address has changed. To find the Zyxel Device's current LAN IP address, in NCC, go to **Site-wide > Devices > Access points** screen or the gateway to which the AP is connected.

Alternatively, disconnect the gateway or disable its DHCP server function and use the Zyxel Device's default static LAN IP address (192.168.1.2).

Figure 171 Cloud Managed AP Application

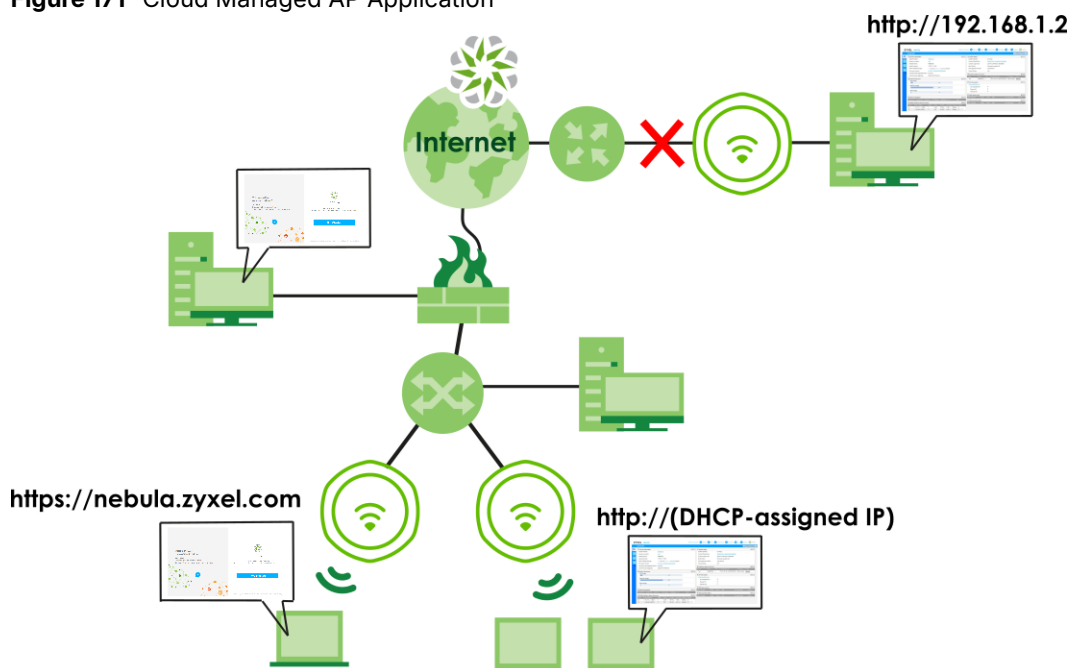

23.2 Local GUI Screens in Cloud Managed Mode

When your Zyxel Device is managed by NCC, you can access only the following screens through the Web Configurator:

- **Dashboard**

- **Maintenance > File Manager > Firmware Package**
- **Maintenance > File Manager > Shell Script**
- **Maintenance > Legal and Regulatory > Legal and Regulatory**
- **Maintenance > Diagnostics > Diagnostics**
- **Maintenance > Diagnostics > Remote Capture**
- **Maintenance > Log > View Log**
- **Maintenance > Reboot > Reboot**

These screens also have fewer options than those in standalone Zyxel Devices. The rest of the Zyxel Device's features must be configured through NCC.

CHAPTER 24

Dashboard

24.1 Overview

This screen displays general AP information, and NCC information in widgets that you can rearrange to suit your needs. You can also edit and refresh individual widgets.

These screens also have fewer options than those in standalone Zyxel Devices. The rest of the Zyxel Device's features must be configured through NCC.

Figure 172 Dashboard

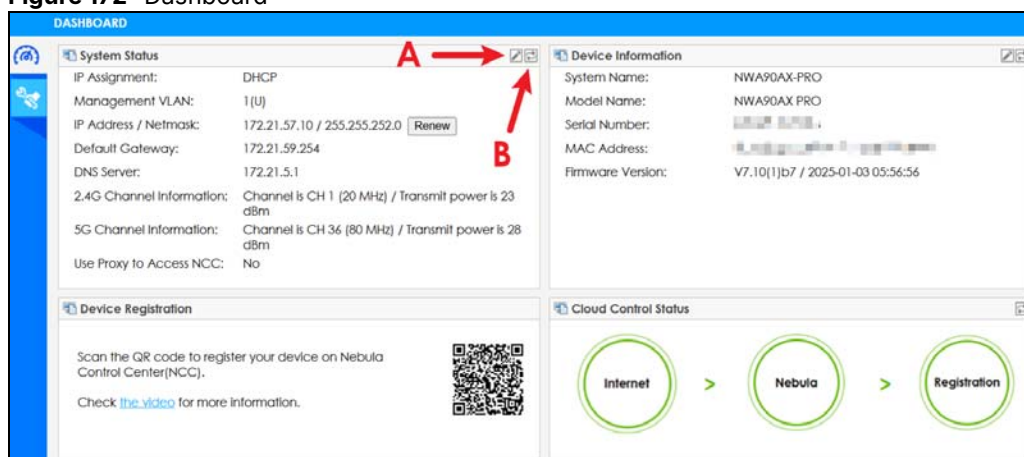

The following table describes the labels in this screen.

Table 106 Dashboard

LABEL	DESCRIPTION
Edit (A)	Click this to open the setup window to configure settings such as the IP address, VLAN, system name, and other network parameters.
Refresh Now (B)	Click this to update the widget's information immediately.
System Status	
IP Assignment	This field displays how the interface gets its IP address. Static - This interface has a static IP address. DHCP Client - This interface gets its IP address from a DHCP server.
Management VLAN	This field displays the management VLAN ID for the Zyxel Device.
IP Address / Netmask	This field displays the current IP address and subnet mask assigned to the interface. If the IP address is 0.0.0.0, the interface is disabled or did not receive an IP address and subnet mask through DHCP. If the interface has a dynamic IP address, click Renew to update the IP address for the interface.
Default Gateway	This field displays the IP address of the default outgoing gateway.

Table 106 Dashboard (continued)

LABEL	DESCRIPTION
DNS Server	This field display the IP address of the DNS server.
2.4G Channel Information	This field displays the channel number the Zyxel Device is using and its output power in the 2.4 GHz spectrum. This shows Not activated if the wireless LAN is disabled.
5G Channel Information	This field displays the channel number the Zyxel Device is using and its output power in the 5 GHz spectrum. This shows Not activated if the wireless LAN is disabled.
Use Proxy to Access NCC	This displays whether the Zyxel Device uses a proxy server to access the NCC.
Device Information	
System Name	This field displays the name used to identify the Zyxel Device on any network.
Model Name	This field displays the model name of this Zyxel Device.
Serial Number	This field displays the serial number of the Zyxel Device.
MAC Address	This field displays the MAC address of the Zyxel Device.
Firmware Version	This field displays the firmware version of the Zyxel Device.
Device Registration	This field displays the information on NCC registration.
Cloud Control Status	<p>This field displays:</p> <ul style="list-style-type: none"> • The Zyxel Device Internet connection status. • The connection status between the Zyxel Device and NCC. • The Zyxel Device registration status on NCC. <p>Mouse over the circles to display detailed information.</p> <p>To pass your Zyxel Device management to NCC, first make sure your Zyxel Device is connected to the Internet. Then go to NCC and register your Zyxel Device.</p> <p>1. Internet</p> <p>Green - The Zyxel Device is connected to the Internet.</p> <p>Orange - The Zyxel Device is not connected to the Internet.</p> <p>2. Nebula</p> <p>Green - The Zyxel Device is connected to NCC.</p> <p>Orange - The Zyxel Device is not connected to NCC.</p> <p>3. Registration</p> <p>Green - The Zyxel Device is registered on NCC.</p> <p>Gray - The Zyxel Device is not registered on NCC.</p>

If the Zyxel Device cannot connect to the Internet or to NCC, move the mouse over the status circle to check the error message. See the NCC (Nebula Control Center) User's Guide for more information.

Figure 173 Dashboard > Cloud Control Status

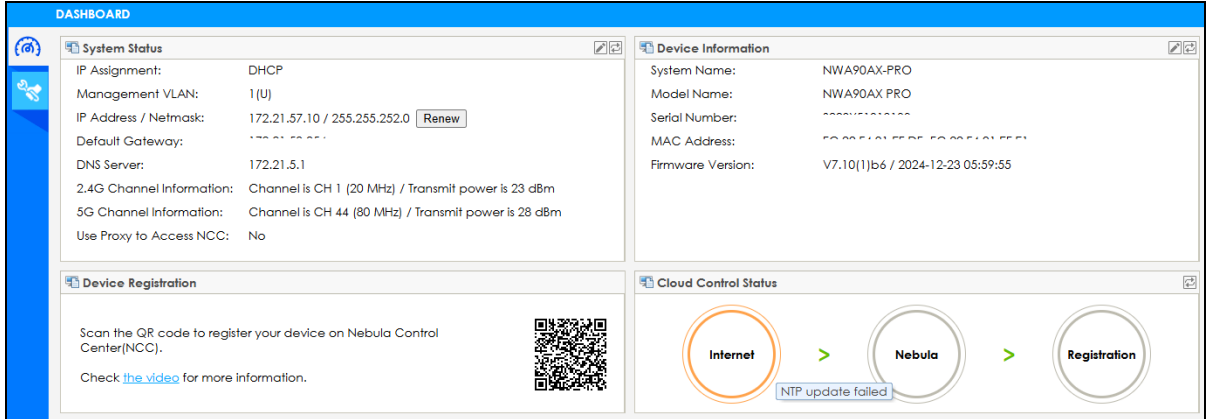

24.2 Edit System Status

Use this screen to configure the Zyxel Device's network setting and allow a proxy to access NCC.

24.2.1 Network

Use this screen to configure the VLAN ID, IP address and time server. To access this screen, click **Dashboard > Edit (System Status) > Network**.

See [VLAN](#) for information about VLAN.

See [Overview](#) for information about IP addresses.

Figure 174 Dashboard > Edit (System Status) > Network

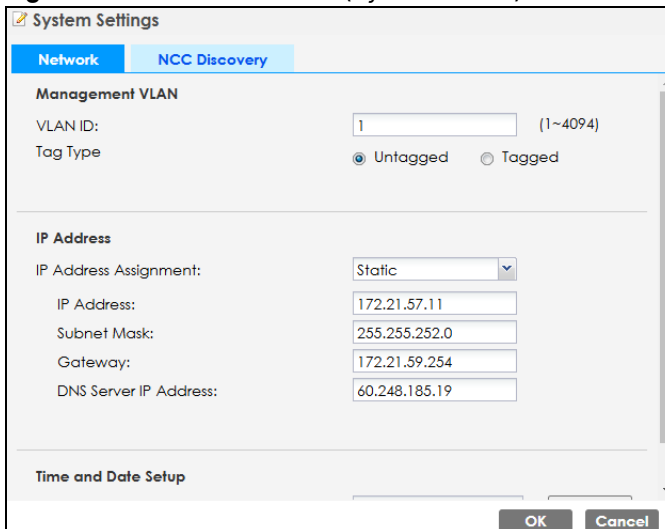

Each field is described in the following table.

Table 107 Dashboard > Edit (System Status) > Network

LABEL	DESCRIPTION
Management VLAN	
VLAN ID	Enter a VLAN ID for the Zyxel Device to use to tag traffic originating from this SSID. Make sure your VLAN settings allow the Zyxel Device to connect to the Internet so you could manage it with NCC.
Tag Type	Select tagged to make the Zyxel Device adds the Management VLAN ID to outbound traffic transmitted through its Ethernet port. If you select Untagged , the outbound traffic transmitted through the Zyxel Device Ethernet port will NOT be tagged with the Management VLAN ID.
IP Address	
IP Address Assignment	Select DHCP to make the interface a DHCP client and automatically get the IP address, subnet mask, gateway and DNS Server IP address from a DHCP server. Select Static IP to specify the IP address, subnet mask, gateway and DNS server IP address manually.
Use Fixed DNS Server IP Address	Select this if you have a preferred DNS server that you want to specify manually even if the IP type is DHCP. Setting a fixed DNS server IP address may help if you experience unreliable DNS resolution.
DNS Server IP Address	Enter the IP address of a DNS server.
IP Address	Enter the IP address for this interface.
Subnet Mask	Enter the subnet mask of this interface in dot decimal notation. The subnet mask indicates what part of the IP address is the same for all computers in the network.
Gateway	Enter the IP address of the gateway. The Zyxel Device sends packets to the gateway when it does not know how to route the packet to its destination. The gateway should be on the same network as the interface.
DNS Server IP Address	Enter the IP address of the DNS server.
Time and Date Setup	
Time Server Address	Enter the IP address or URL of your time server. Check with your ISP/network administrator if you are unsure of this information.
Sync. Now	Click this button to have the Zyxel Device get the time and date from the time server (see the Time Server Address field). This also saves your changes.
OK	Click OK to save your changes.
Cancel	Click Cancel to exit this screen without saving your changes.

24.2.2 NCC Discovery

Use this screen to allow a proxy to access NCC. To access this screen, click **Dashboard > Edit (System Status) > NCC Discovery**.

Select the checkbox and click **OK** so that the Zyxel Device can access the NCC through the proxy server.

Figure 175 Dashboard > Edit (System Status) > NCC Discovery

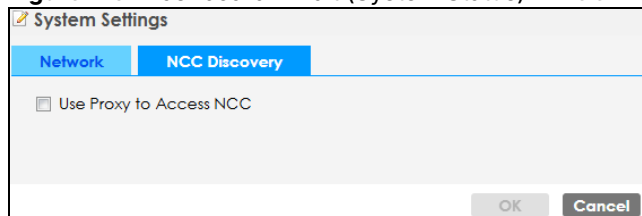

24.3 Edit Device Information

Use this screen to configure the Zyxel Device's system name. To access this screen, click **Dashboard > Edit (Device Information)**.

Enter the system name and click **OK** to save the change.

Figure 176 Dashboard > Edit (Device Information)



The screenshot shows a dialog box titled "Device Setting" with a pencil icon. Inside the dialog, there is a label "System Name" followed by a text input field containing the value "WBE510D". At the bottom right of the dialog, there are two buttons: "OK" and "Cancel".

CHAPTER 25

Maintenance

25.1 Overview

When the Zyxel Device is set to work in cloud managed mode, the **Maintenance** screens allow you to upload firmware, manage shell script files, generate a diagnostic file, view log messages, or reboot the Zyxel Device.

25.1.1 What You Can Do in this Chapter

- The **File Manager > Firmware Package** screen ([Firmware Package](#)) displays current firmware information and allows you to upload firmware file.
- The **File Manager > Shell Script** screen ([Shell Script](#)) allows you to store, name, download, and upload shell script files.
- The **Legal and Regulatory > Legal and Regulatory** screen ([Legal and Regulatory](#)) allows you to view the legal and regulatory information.
- The **Diagnostics > Diagnostics** screen ([Diagnostics](#)) allows you to generate a file containing the Zyxel Device's configuration and diagnostic information if you need to provide it to customer support during troubleshooting.
- The **Diagnostics > Remote Capture** screen ([Remote Capture](#)) allows you to enable remote packet captures on wired or wireless interfaces through an external packet analyzer.
- The **Log > View Log** screen ([View Log](#)) displays the Zyxel Device's current log messages when it is disconnected from the NCC.
- The **Reboot > Reboot** screen ([Reboot](#)) allows you to reboot the Zyxel Device.

25.2 Firmware Package

Click **Maintenance > File Manager > Firmware Package** to open this screen. Use the **Firmware Package** screen to check your current firmware information and upload firmware to the Zyxel Device. You can manually download the new firmware from the Zyxel website.

Note: The Web Configurator is the recommended method for uploading firmware. You only need to use the command line interface if you need to recover the firmware. See the CLI Reference Guide for how to determine if you need to recover the firmware and how to recover it.

The firmware update can take up to five minutes. Do not turn off or reset the Zyxel Device while the firmware update is in progress!

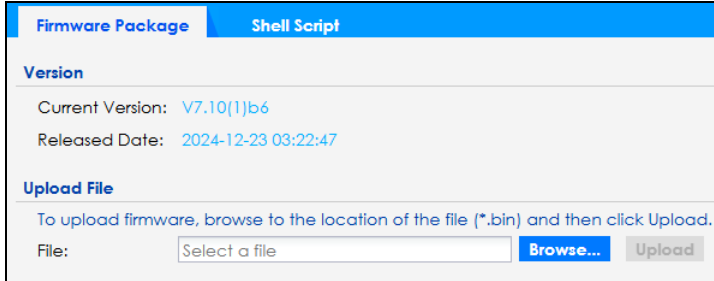
Figure 177 Maintenance > File Manager > Firmware Package

The following table describes the labels in this screen.

Table 108 Maintenance > File Manager > Firmware Package

LABEL	DESCRIPTION
Version	
Current Version	This is the firmware version.
Released Date	This is the date that the version of the firmware was created.
Upload File	
File Path	Enter the location of the file you want to upload in this field or click Browse... to find it.
Browse...	Click Browse... to find the .bin file you want to upload. Remember that you must decompress compressed (.zip) files before you can upload them.
Upload	Click Upload to begin the upload process. This process may take up to two minutes.

Firmware Download Failed

The following pop-up messages display the causes and solutions for firmware download failure.

Firmware download failed due to an Internet error. Refer to [Internet Access](#) for more information.

Figure 178 Firmware Download Failed. Check Internet Access.

Firmware download failed due to a DNS problem. Please check your device's DNS settings.

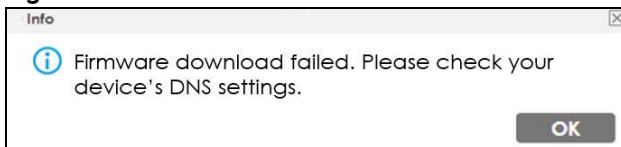
Figure 179 Firmware Download failed. Check DNS Settings.

Firmware download failed. Download the new firmware manually from the Zyxel website. Then, go to the **Maintenance > File Manager > Firmware Package** screen to upload the new firmware.

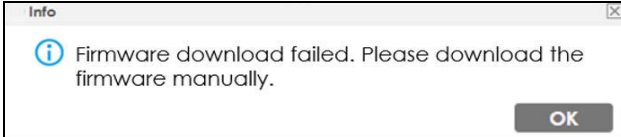
Figure 180 Firmware Download Failed. Download Manually.

Note: The Zyxel Device automatically reboots after a successful upload.

The Zyxel Device automatically restarts causing a temporary network disconnect to devices connected to its network. In some operating systems, you may see the following icon on your desktop.

Figure 181 Network Temporarily Disconnected

After five minutes, log in again and check your new firmware version in the **Dashboard** screen.

25.3 Shell Script

A shell script is a list of commands to manage the Zyxel Device. Use a text editor to create the shell script files. They must use a ".zysh" filename extension. For example, test.zysh.

Click **Maintenance > File Manager > Shell Script** to open this screen. Use the **Shell Script** screen to store, name, download, and upload shell script files. You can store multiple shell script files on the Zyxel Device at the same time.

See [What you Need to Know](#) for information about shell scripts.

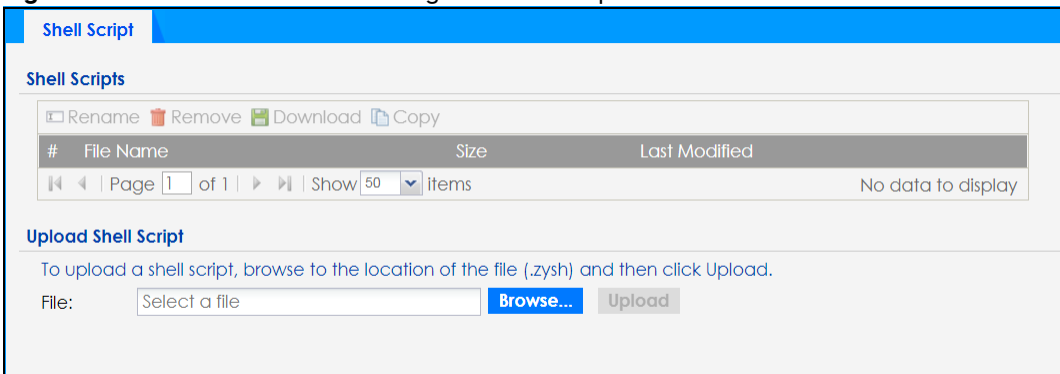
Figure 182 Maintenance > File Manager > Shell Script

- 1 In the text editor, save the shell script with a .zysh filename extension. Select **All Files** as the file type.

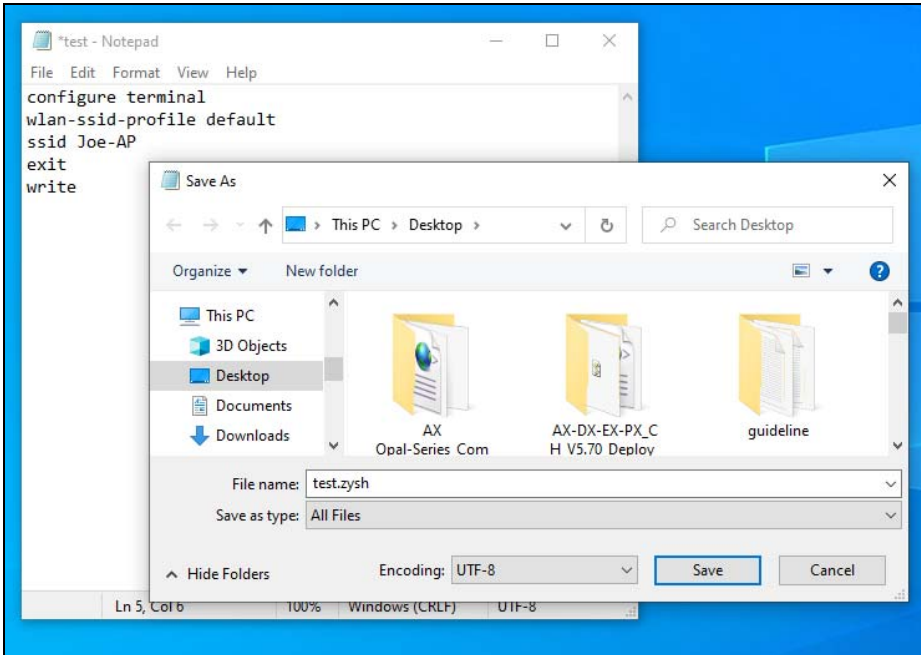

- 2 Go to the **Maintenance > File Manager > Shell Script** screen. Click **Browse...** to upload the .zysh file.

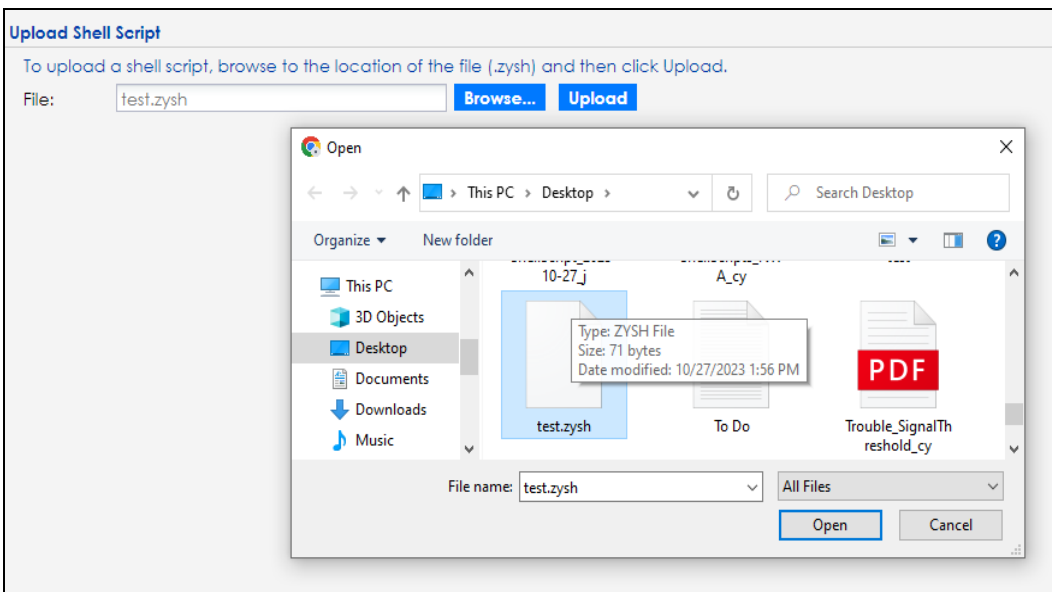

- 3 Click **Upload**. The uploaded shell script will be shown in the **Shell Scripts** field.

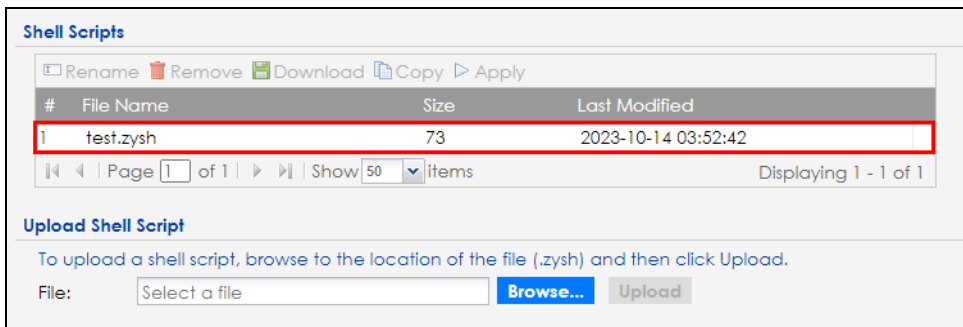

Each field is described in the following table.

Table 109 Maintenance > File Manager > Shell Script

LABEL	DESCRIPTION
Shell Scripts	
Rename	<p>Use this button to change the label of a shell script file on the Zyxel Device.</p> <p>You cannot rename a shell script to the name of another shell script in the Zyxel Device.</p> <p>Click a shell script's row to select it and click Rename to open the Rename File screen.</p> <p>Specify the new name for the shell script file. Use up to 25 characters (including a-zA-Z0-9;~!@#\$\$%^&()+_+[]{}',.-).</p> <p>Click OK to save the renamed file or click Cancel to close the screen without saving a renamed file.</p>
Remove	<p>Click a shell script file's row to select it and click Delete to delete the shell script file from the Zyxel Device.</p> <p>A pop-up window asks you to confirm that you want to delete the shell script file. Click OK to delete the shell script file or click Cancel to close the screen without deleting the shell script file.</p>
Download	<p>Click a shell script file's row to select it and click Download to save the configuration to your computer.</p>
Copy	<p>Use this button to save a duplicate of a shell script file on the Zyxel Device.</p> <p>Click a shell script file's row to select it and click Copy to open the Copy File screen.</p> <p>Specify a name for the duplicate file. Use up to 25 characters (including a-zA-Z0-9;~!@#\$\$%^&()+_+[]{}',.-).</p> <p>Click OK to save the duplicate or click Cancel to close the screen without saving a duplicate of the configuration file.</p>
Apply	<p>Use this button to have the Zyxel Device use a specific shell script file.</p> <p>Click a shell script file's row to select it and click Apply to have the Zyxel Device use that shell script file. You may need to wait awhile for the Zyxel Device to finish applying the commands.</p>
#	This column displays the number for each shell script file entry.
File Name	This column displays the label that identifies a shell script file.
Size	This column displays the size (in KB) of a shell script file.
Last Modified	This column displays the date and time that the individual shell script files were last changed or saved.
Upload Shell Script	
File	Enter the location of the file you want to upload in this field or click Browse... to find it.
Browse...	Click Browse... to find the .zysh file you want to upload.
Upload	Click Upload to begin the upload process. This process may take up to several minutes.

25.4 Legal and Regulatory

Use this screen to view the information on legal and regulatory. This screen may not display depending on the Zyxel Device model you are using.

Figure 183 Maintenance > Legal and Regulatory > Legal and Regulatory

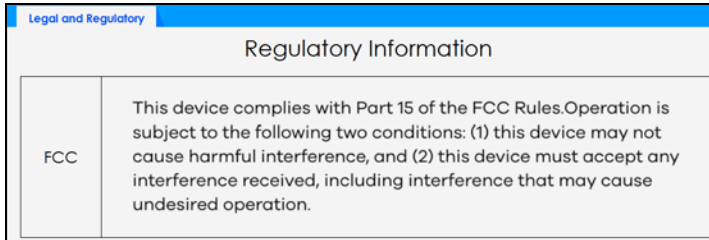

25.5 Diagnostics

This screen provides an easy way for you to generate a file containing the Zyxel Device's configuration and diagnostic information. You may need to generate this file and send it to customer support during troubleshooting. All categories of settings and shell script files stored on the Zyxel Device will be included in the diagnostic file.

Click **Maintenance > Diagnostics > Diagnostics** to open the **Diagnostics** screen. Click **Collect Now** to have the Zyxel Device create a new diagnostic file.

Figure 184 Maintenance > Diagnostics > Diagnostics

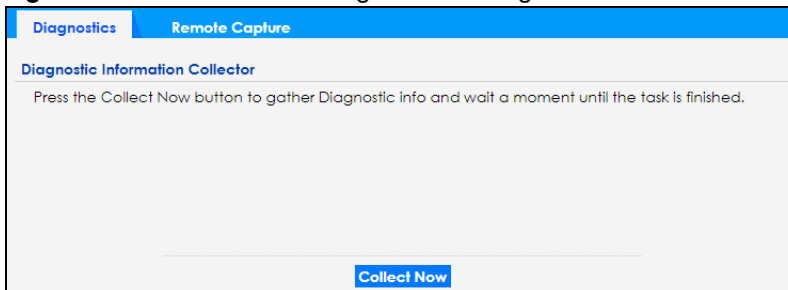

The **Debug Information Collector** screen then displays showing whether the collection is in progress, was successful, or has failed. When the data collection is done, click **Download** to save the most recent diagnostic file to a computer.

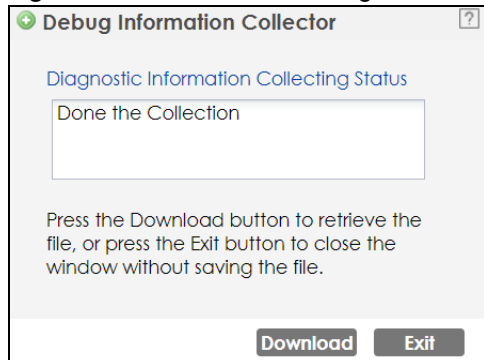
Figure 185 Maintenance > Diagnostics > Diagnostics: Debug Information Collector

25.6 Remote Capture

Use this screen to capture network traffic going through the Zyxel Device and output the captured packets to a packet analyzer (also known as network or protocol analyzer) such as Wireshark. If the Zyxel Device is connected to the Zyxel gateway or ZyWALL, you might need to configure the Zyxel gateway or ZyWALL to allow remote capture on the Zyxel Device.

Click **Maintenance > Diagnostics > Remote Capture** to open the **Remote Capture** screen.

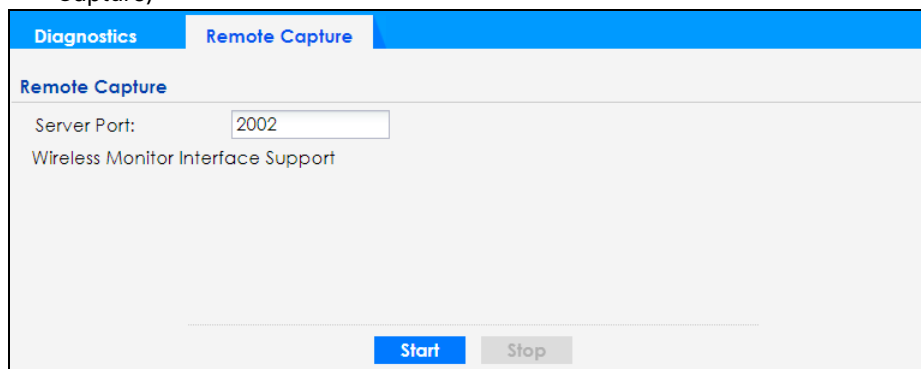
Figure 186 Maintenance > Diagnostics > Remote Capture (Zyxel Device that supports Wireless Remote Capture)

The following table describes the labels in this screen.

Table 110 Maintenance > Diagnostics > Remote Capture

LABEL	DESCRIPTION
Server Port	Enter the number of the server port you want the packet analyzer to connect to in order to capture traffic going through the Zyxel Device. The default port number is 2002.
Start	Click this button to allow the packet analyzer to start capturing traffic going through the Zyxel Device.
Stop	Click this button to stop the packet analyzer from capturing traffic going through the Zyxel Device.

25.7 View Log

The NCC periodically gathers log files from the devices being managed by it. Before the NCC pulls logs from the Zyxel Device or when the Zyxel Device is disconnected from the NCC, you can use this screen to view its current log messages. To access this screen, click **Maintenance > Log > View Log**.

Note: When a log reaches the maximum number of log messages, new log messages automatically overwrite existing log messages, starting with the oldest existing log message first.

Events that generate an alert (as well as a log message) display in red. Regular logs display in black. Click a column's heading cell to sort the table entries by that column's criteria. Click the heading cell again to reverse the sort order.

Figure 187 Maintenance > Log > View Log

The screenshot shows the 'View Log' interface. At the top, there is a 'View Log' header and a 'Hide Filter' button. Below this, the 'Logs' section contains a message: 'Log will be displayed when this access point is not connected to the Nebula.' There are several filter fields: 'Display' (set to 'System'), 'Priority' (set to 'any'), 'Source Address', 'Destination Address', 'Source Interface' (set to 'any'), 'Destination Interface' (set to 'any'), 'Protocol' (set to 'any'), and 'Keyword'. A 'Search' button is located below these fields. Below the filters, there are 'Refresh' and 'Clear Log' buttons. The main area is a table with columns: '#...', 'Time', 'P...', 'C...', 'Message', 'Source', 'Destination', and 'Note'. The table contains five log entries, with the first, third, and fifth entries highlighted in red. The first entry is '20 2019-11-27 06:4... a... S... Port 0 is up! The link speed is 1000M/Full.' The second entry is '26 2019-11-27 06:4... a... S... Port 0 is down!'. The third entry is '62 2019-11-27 06:3... i... S... EnterpriseWLAN is configured successfully with s...'. The fourth entry is '83 2019-11-27 06:3... a... S... Port 0 is up! The link speed is 1000M/Full.' The fifth entry is '85 2019-11-27 06:3... a... S... Port 0 is down!'. At the bottom, there is a pagination control showing 'Page 1 of 1' and 'Show 20 items', and a status 'Displaying 1 - 5 of 5'.

The following table describes the labels in this screen.

Table 111 Maintenance > Log > View Log

LABEL	DESCRIPTION
Show Filter / Hide Filter	Click this button to show or hide the filter settings. If the filter settings are hidden, the Display field is available. If the filter settings are shown, the Display , Priority , Source Address , Destination Address , Source Interface , Destination Interface , Protocol , Keyword , and Search fields are available.
Display	Select the category of log message(s) you want to view. You can also view All Logs at one time, or you can view the Debug Log .
Priority	This displays when you show the filter. Select the priority of log messages to display. The log displays the log messages with this priority or higher. Choices are: any , emerg , alert , crit , error , warn , notice , and info , from highest priority to lowest priority. This field is read-only if the Display is Debug Log .
Source Address	This displays when you show the filter. Enter the source IP address of the incoming packet that generated the log message. Do not include the port in this filter.

Table 111 Maintenance > Log > View Log (continued)

LABEL	DESCRIPTION
Destination Address	This displays when you show the filter. Enter the IP address of the destination of the incoming packet when the log message was generated. Do not include the port in this filter.
Source Interface	This displays when you show the filter. Select the source interface of the packet that generated the log message.
Destination Interface	This displays when you show the filter. Select the destination interface of the packet that generated the log message.
Protocol	This displays when you show the filter. Select a service protocol whose log messages you would like to see.
Keyword	This displays when you show the filter. Enter a keyword to look for in the Message , Source , Destination and Note fields. If a match is found in any field, the log message is displayed. You can use up to 63 alphanumeric characters and the underscore, as well as punctuation marks (') ,;?! +-*/= # \$ % @ ; the period, double quotes, and brackets are not allowed.
Search	This displays when you show the filter. Click this button to update the log using the current filter settings.
Refresh	Click this to update the list of logs.
Clear Log	Click this button to clear the whole log, regardless of what is currently displayed on the screen.
#	This field is a sequential value, and it is not associated with a specific log message.
Time	This field displays the time the log message was recorded.
Priority	This field displays the priority of the log message. It has the same range of values as the Priority field above.
Category	This field displays the log that generated the log message. It is the same value used in the Display and (other) Category fields.
Message	This field displays the reason the log message was generated. The text "[count=x]", where x is a number, appears at the end of the Message field if log consolidation is turned on and multiple entries were aggregated to generate into this one.
Source	This field displays the source IP address and the port number in the event that generated the log message.
Source Interface	This field displays the source interface of the packet that generated the log message.
Destination	This field displays the destination IP address and the port number of the event that generated the log message.
Destination Interface	This field displays the destination interface of the packet that generated the log message.
Protocol	This field displays the service protocol in the event that generated the log message.
Note	This field displays any additional information about the log message.

25.8 Reboot

This screen allows users to restart the Zyxel Device. To access this screen, click **Maintenance > Reboot > Reboot**.

If you made changes in the CLI, you have to use the `write` command to save the configuration. They do not change when you reboot the Zyxel Device.

Reboot is different from reset; reset returns the Zyxel Device to its default configuration.

You can reboot your Zyxel Device when the Internet connection is slow or intermittent.

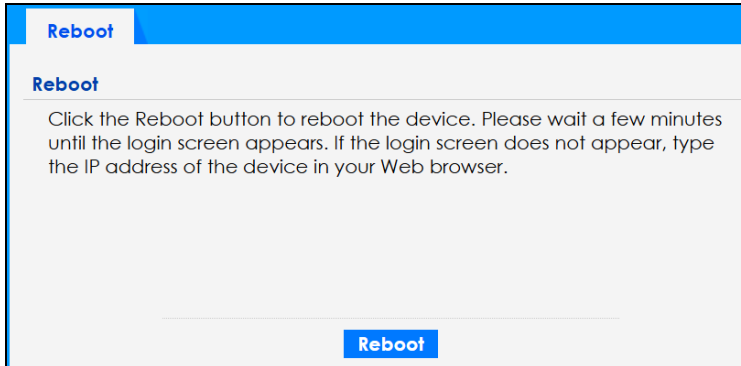
Figure 188 Maintenance > Reboot > Reboot

The following table describes the labels in this screen.

Table 112 Maintenance > Reboot > Reboot

LABEL	DESCRIPTION
Reboot	Click Reboot then click Yes to restart the Zyxel Device immediately.

After the Zyxel Device reboots, wait a few minutes until the login screen appears. If the login screen does not appear, type the IP address of the Zyxel Device in your Web browser.

You can also use the CLI command `reboot` to restart the Zyxel Device.

PART III

Appendices and Troubleshooting

CHAPTER 26

Troubleshooting

26.1 Overview

This chapter offers some suggestions to solve problems you might encounter. The potential problems are divided into the following categories.

- [Power, Hardware Connections, and LEDs](#)
- [Zyxel Device Management, Access, and Login](#)
- [Internet Access](#)
- [WiFi Network](#)
- [Resetting the Zyxel Device](#)

26.2 Power, Hardware Connections, and LEDs

[The Zyxel Device does not turn on. None of the LEDs turn on.](#)

If you are using a power adapter to power the Zyxel Device:

- 1 Make sure you are using a compatible power adapter.
- 2 Make sure the power adapter is securely connected to the Zyxel Device and plugged into an appropriate power source.
- 3 Make sure the power adapter is functional.
- 4 If the problem persists, contact Zyxel technical support.

If you are using a PSE or PoE injector to power the Zyxel Device:

- 1 Make sure you are using the correct PoE port on the PSE or PoE injector.
- 2 Make sure the PSE or PoE injector is functional.
 - Check whether the PSE or PoE injector is malfunctioning. See your PSE or PoE injector user's guide for more information.

- If the connected PSE or PoE injector does not fully comply with the Zyxel Device's supported PoE standard, replace it with compliant PSE or PoE injector. See [Zyxel Device Product Feature Comparison](#) for the Zyxel Device's supported PoE standards. Certain PSEs can adjust the power delivered to each PD based on the PoE standard supported by the PD. For detailed instructions, refer to your PSE User's Guide.
- 3 Make sure the Ethernet cable connected to the PSE or PoE injector is functional.
 - Check whether the Ethernet cable is malfunctioning.
 - Use the correct type of Ethernet cable for the PoE standard supported by the Zyxel Device. See [Zyxel Device Product Feature Comparison](#) for the Zyxel Device's supported PoE standards and see [PoE](#) for the compliant Ethernet cables.
 - 4 If the problem persists, contact Zyxel technical support.

The LED does not behave as expected.

- 1 Make sure you understand the normal behavior of the LED. See [Zyxel Device LED](#).
- 2 Check the hardware connections. See the Quick Start Guide.
- 3 Inspect your cables for damage. Contact the vendor to replace any damaged cables.
- 4 Disconnect and re-connect the power adapter or PoE power injector to the Zyxel Device.
- 5 If the problem continues, contact the vendor.

I want to reduce the power consumption of my Zyxel Device.

There are several ways to reduce your Zyxel Device's power consumption.

- **Schedule WiFi networks**

Schedule your WiFi networks based on usage patterns to reduce unnecessary wireless activity. You can enable the **SSID schedule** feature to control when each network is active.

- Web configurator: Go to **CONFIGURATION > Object > AP Profile > SSID > SSID List > Edit SSID Profile**, and select the **Schedule SSID** checkbox.
- NCC: Go to **Site-wide > Configure > Access points > SSID advanced settings > SSID schedule**.

- **Minimize the number of SSIDs that you configure.**

A lower number of configured SSIDs reduces unnecessary wireless overhead and helps lower power consumption.

- Web configurator: Go to **CONFIGURATION > Object > AP Profile > SSID > SSID List**.
- NCC: Go to **Site-wide > Configure > Access points > SSID advanced settings**.

- **Limit the number of connected WiFi clients**

Fewer connected clients reduce network traffic and processing load. Change the WiFi password periodically and just inform allowed WiFi clients.

- Web configurator: Go to **CONFIGURATION > Object > AP Profile > SSID > Security List > Edit Security Profile**, and change the **Pre-Shared Key** under **Authentication Settings**.
- NCC: Go to **Site-wide > Configure > Access points > SSID advanced settings > Network access > Security options**, select the **WPA Personal** option and modify the key.

The screenshot shows the 'Network access' configuration page. Under 'Security options', three radio buttons are visible: 'Open', 'Enhanced-open', and 'WPA Personal With'. The 'WPA Personal With' option is selected. Below it, there is a dropdown menu set to 'WPA1' and a text input field for the 'Pre-Shared Key' containing the value '0987654321'. A red box highlights this key field. There is also a 'Model list' link next to the key field.

- **Disable unused 5 GHz and 6 GHz networks**
Higher frequency bands such as 5 GHz and 6 GHz may consume more power than 2.4 GHz under heavy traffic. If not needed, disable the 5 GHz and 6 GHz networks to help reduce power consumption.
 - Web configurator: Go to **CONFIGURATION > Wireless > AP Management > WLAN Setting**.
 - NCC: Go to **Site-wide > Configure > Access points > SSID advanced settings > Advanced settings > Band mode**.
- **Align the APs properly and reduce transmit power**
Proper AP alignment helps optimize link transmissions and reduces transmit power. Adjust the maximum output power according to the distance between the AP and its clients, and the number of APs in a coverage area. Lowering maximum output power reduces energy usage.
 - Web configurator: Go to **CONFIGURATION > Wireless > AP Management > WLAN Setting**, and adjust the **Max Output Power**.
 - NCC: Go to **Site-wide > Configure > Access points > Radio settings**, and adjust the **Maximum output power**.

26.3 Zyxel Device Management, Access, and Login

I forgot the IP address for the Zyxel Device.

- 1 The default in-band IP address in standalone mode is **https://DHCP-assigned IP** (when connecting to a DHCP server) or **192.168.1.2**.
- 2 If you changed the IP address and have forgotten it, you have to reset the Zyxel Device to its factory defaults. See [Resetting the Zyxel Device](#).
- 3 If your Zyxel Device is a DHCP client, you can find your IP address from the DHCP server. This information is only available from the DHCP server which allocates IP addresses on your network. Find this information directly from the DHCP server or contact your system administrator for more information.
- 4 If the NCC has managed the Zyxel Device, you can also check the NCC's **Site-wide > Devices > Access points** screen for the Zyxel Device's current LAN IP address.

I cannot see or access the **Login** screen in the Web Configurator.

- 1 Make sure you are using the correct IP address.
 - The default IP address (in standalone mode) is 192.168.1.2.
 - If you changed the IP address, use the new IP address.
 - If you changed the IP address and have forgotten it, see the troubleshooting suggestions for [I forgot the IP address for the Zyxel Device](#).
- 2 Check the hardware connections, and make sure the LED is behaving as expected. See the Quick Start Guide and [Zyxel Device LED](#).
- 3 Make sure your Internet browser does not block pop-up windows and has JavaScripts and Java enabled.
- 4 Make sure your computer is in the same subnet as the Zyxel Device. (If you know that there are routers between your computer and the Zyxel Device, skip this step.)
 - If there is a DHCP server on your network, make sure your computer is using a dynamic IP address. Check the DHCP IP address assigned to your Zyxel Device on the connected router.
 - If there is no DHCP server on your network, make sure your computer's IP address is in the same subnet as the Zyxel Device.
- 5 Reset the Zyxel Device to its factory defaults, and try to access the Zyxel Device with the default IP address. See [Resetting the Zyxel Device](#).
- 6 If the problem continues, contact the network administrator or vendor, or try one of the advanced suggestions.

Advanced Suggestions

- Try to access the Zyxel Device using another service, such as SSH. If you can access the Zyxel Device, check the remote management settings to find out why the Zyxel Device does not respond to HTTP.
- If your computer is connected wirelessly, use a computer that is connected to a **LAN/ETHERNET** port.

I forgot the Web Configurator password.

- 1 The default password is unique to each Zyxel Device and shown on the label. If your Zyxel Device does not have a password on the label, use "1234". If the Zyxel Device is connected to the NCC and registered, check the NCC for the password.
- 2 If this does not work, you have to reset the Zyxel Device to its factory defaults. See [Resetting the Zyxel Device](#).

I can see the **Login** screen, but I cannot log into the Zyxel Device.

- 1 Clear your browser's cache.
- 2 Check the Zyxel Device's management mode.
 - The default password is unique to each Zyxel Device and shown on the label. If your Zyxel Device does not have a password on the label, use "1234". If you have changed the username and password, use the ones you configured to log in.
 - If the Zyxel Device is in cloud managed mode, use the Nebula **Local credentials Password** to log into the cloud managed mode local GUI. The **Local credentials Password** can be found in **Site-wide > Configure > Site settings > Device configuration: Local credentials: Password** in the NCC portal.
- 3 Depending on your Zyxel Device's management mode, make sure you have entered the correct user name and password. These fields are case-sensitive, so check if [Caps Lock] is on or off.

Note: Steps 1 and 2 are applicable if you get an "Invalid password" error message when using some functions in the ZON utility. See [Zyxel One Network \(ZON\) Utility](#) for more information.

- 4 Disconnect and re-connect the power adapter or PoE power injector to restart the Zyxel Device.
- 5 If this does not work, you have to reset the Zyxel Device to its factory defaults. See [Resetting the Zyxel Device](#).

[I cannot use FTP to upload or download the configuration file.](#)

Ensure you have enabled FTP in the **Configuration > System > FTP** screen.

[I cannot upload the firmware uploaded using FTP.](#)

The Web Configurator is the recommended method for uploading firmware in standalone mode. For managed Zyxel Devices, using the NCC is recommended. You only need to use FTP if you need to recover the firmware. See the CLI Reference Guide for how to determine if you need to recover the firmware and how to recover it.

[NCC is managing the Zyxel Device, but the NCC cannot access the Zyxel Device.](#)

Connect to the Zyxel Device directly and log into the Web Configurator with the credentials configured in NCC.

[I cannot register the Zyxel Device in NCC because it's already registered by the previous owner.](#)

- If the previous owner has registered the Zyxel Device in NCC and has enabled the NCC **Override device ownership** feature in the **Organization-wide > Organization-wide manage > Organization settings** screen, use the Nebula Mobile app to scan the NCC QR code on the back label of the Zyxel Device to register with NCC.
- If the previous owner has registered it in NCC and has locked the Zyxel Device with the NCC **Override device ownership** feature in the **Organization-wide > Organization-wide manage > Organization settings** screen, inform the previous owner to unregister the Zyxel Device or contact Zyxel technical support.

The Zyxel Device is already registered with NCC, but it is still in standalone mode; it cannot connect to the NCC.

- 1 Check the Zyxel Device LED and make sure the Zyxel Device is on and ready for use.
- 2 Check your network's firewall/security settings. Make sure the following ports are allowed:
 - TCP: 443, 4335, and 6667
 - UDP: 123 is allowed.
- 3 Make sure your Zyxel Device has obtained an IP address and can access the Internet. Check the **Cloud Control Status** on the **Dashboard** screen for your Internet connection.
- 4 Check your network's VLAN settings (see [VLAN](#)). You may have to change the Management VLAN settings of the Zyxel Device to allow it to connect to the Internet and access the NCC.

Note: Changing the management VLAN and IP address settings on the Zyxel Device also pushes these changes to the NCC. Do this only if your device cannot otherwise connect to the NCC.

- 5 Make sure your Zyxel Device does not have to go through network authentication such as a captive portal. If your network uses a captive portal, the network administrator may have to create a new VLAN without this requirement. Change your Zyxel Device's management VLAN settings as necessary.
- 6 Make sure your DNS server can resolve `d.nebula.zyxel.com`. Open the **Command Prompt** on your computer, enter `nslookup d.nebula.zyxel.com`, see if the DNS server can return the resolved IP address. If not, you can try set your gateway to use the Google Public DNS server 8.8.8.8. Or, set the DNS server address in the Zyxel Device Web Configurator. Go to **Configuration > Network > IP Setting**, select **Use Fixed IP Address**. Set the **DNS Server IP Address**: to 8.8.8.8. Click **Apply**.

Some features I set using the NCC do not work as expected.

- 1 Make sure your Zyxel Device can access the Internet.
- 2 Make sure the NCC can access the Zyxel Device. Check your network's firewall/security settings. Make sure the following ports are allowed:
 - TCP: 443, 4335, and 6667
 - UDP: 123

- 3 After changing your Zyxel Device settings using the NCC, wait 1-2 minutes for the changes to take effect.

I can only see newer logs. Older logs are missing.

When a log reaches the maximum number of log messages (see [Zyxel Device Product Feature Comparison](#)), new log messages automatically overwrite the oldest log messages.

The commands in my configuration file or shell script are not working properly.

- In a configuration file or shell script, use “#” or “!” as the first character of a command line to have the Zyxel Device treat the line as a comment.
- Your configuration files or shell scripts can use “exit” or a command line consisting of a single “!” to have the Zyxel Device exit sub command mode.
- Include `write` commands in your scripts. Otherwise the changes will be lost when the Zyxel Device restarts. You could use multiple `write` commands in a long script.

Note: “exit” or “!” must follow sub commands if it is to make the Zyxel Device exit sub command mode.

My Zyxel Device’s CPU usage is too high.

The Zyxel Device may receive too many HTTPS connection requests. Do the following to reduce the number of HTTPS connection requests:

Go to **Configuration > Object > User > Setting** and select **Limit the number of simultaneous logons for administration account**. Set a number in **Maximum number per administration account** to limit the number of simultaneous logins for each admin.

I want to set up multiple Access Points (APs).

Avoid positioning APs in direct line of sight of each other, as this can cause interference and reduce the overall performance of your WiFi network.

In case, it may be necessary to position APs in direct line of sight of each other, you can:

- Adjust the transmit power of each AP in the **Configuration > Wireless > AP Management** screen, so that they are not using too much power and overlapping too much with each other.
- Configure the APs to operate on non-overlapping channels, such as channels 1, 6, and 11 in the 2.4 GHz band, 5 GHz band or 6 GHz band's channels or enabling DCS to let APs scan the best channel to use. This can help to minimize co-channel interference between the APs.

[I only want certain users to access specific parts of my network.](#)

See [Restrict Users' Access to Specific Parts of Your Network](#) for more information on how to allow certain users to access only specific parts of your network.

[I only want admins to use HTTPS or SSH to access the Zyxel Device.](#)

See [Remote Access to the Zyxel Device](#) for more information on how to configure access to the Zyxel Device.

26.4 Internet Access

[Clients cannot access the Internet through the Zyxel Device.](#)

- 1 Check the Zyxel Device's hardware connections, and make sure the LEDs are behaving as expected (refer to [Zyxel Device LED](#)). See the Quick Start Guide and [Overview](#).
- 2 Make sure the Zyxel Device is connected to a broadband modem or router with Internet access and your computer is set to obtain a dynamic IP address.
- 3 If clients are trying to access the Internet wirelessly, make sure the WiFi settings on the WiFi clients are the same as the settings on the Zyxel Device.
- 4 Make sure the Zyxel Device has the same VLAN settings configured as the gateway connected to the Zyxel Device. Traffic tagged with a specific VLAN ID tag can only go to the WiFi clients of the WiFi network that uses the same VLAN ID. If you select **Tagged (As Native VLAN)** in the **Configuration > Network > VLAN** screen, traffic going out from the Zyxel Device Ethernet port will be tagged with the **Management VLAN ID** you set. Devices connected to the Zyxel Device need to have the same VLAN ID configured to receive traffic from the Zyxel Device .
- 5 Disconnect all the cables from your Zyxel Device, and follow the directions in the Quick Start Guide again.
- 6 Reboot the client and reconnect to the Zyxel Device.
- 7 If the problem continues, contact your ISP.

[The Internet connection is slow or intermittent.](#)

- 1 There might be a lot of traffic on the network. Look at the LEDs, and check [Zyxel Device LED](#). If the Zyxel Device is sending or receiving a lot of information, try closing some programs that use the Internet, especially peer-to-peer applications.
- 2 Check the signal strength using the NCC or the Zyxel Device Web Configurator, or the client device itself. If the signal is weak, try moving the client closer to the Zyxel Device (if possible), and look around to see if there are any devices that might be interfering with the wireless network (microwaves, other wireless networks, and so on).
- 3 Reboot the Zyxel Device using the Web Configurator/CLI or the NCC.
- 4 Check the settings for QoS. If it is disabled, activate it. When enabled, raise or lower the priority for some applications.
- 5 If the problem continues, contact the network administrator or vendor.

26.5 WiFi Network

[I cannot connect to the Zyxel Device WiFi network.](#)

- 1 Check the Zyxel Device LED status to make sure the Zyxel Device WiFi is on.
- 2 Make sure your WiFi client is within transmission range of the Zyxel Device.
- 3 Make sure you enter the correct SSID, password (**Pre-Shared Key**). They are case-sensitive. See the Zyxel Device back label for the default SSID and password.
- 4 Make sure your WiFi client is using the same WiFi security type (none, Enhanced-open, WEP, WPA, WPA2, WPA3) as the Zyxel Device. If you have previously changed the security settings, remove the SSID profile on the client device. Reconnect again using the correct SSID, password and security type.
- 5 Make sure the DHCP server is working properly. For example, the client may receive a private IPv4 address such as 192.168.1.x where x is a number for 2 to 254. If the client gets an address like 169.x.x.x, it means the client didn't get a valid IP address from the DHCP server.
- 6 Make sure the DNS server is working properly. If you can ping an IP address, but cannot ping its related URL, then it means there is a DNS server connection issue. For example, if you can ping 8.8.8.8 successfully but fail to ping google.com, there may be a DNS resolution issue.
- 7 Make sure the WiFi adapter on your WiFi client is working properly.
- 8 Make sure the wireless adapter on your WiFi client is IEEE 802.11 compatible and supports the same WiFi standard as the Zyxel Device's active radio. For example, 6 GHz WiFi networks are only available for WiFi clients that support WiFi 6E or higher standards.

[The WiFi connection is slow or intermittent.](#)

The following factors may cause interference:

- Obstacles: walls, ceilings, furniture, and so on.
- Building Materials: metal doors, aluminum studs.
- Electrical devices: microwaves, monitors, electric motors, cordless phones, and other wireless devices.

To optimize the speed and quality of your WiFi connection, you can:

- Move your WiFi device closer to the Zyxel Device if the signal strength is low.
- Reduce wireless interference that may be caused by other wireless networks or surrounding wireless electronics such as cordless phones.
- To ensure the connected WiFi clients receive strong WiFi signal, adjust the minimum signal strength between the Zyxel Device and its WiFi clients by going to the **Configuration > Object > AP Profile > Radio** screen and selecting **Enable Signal Threshold**. To apply the settings to your Zyxel Device, go to the **Configuration > AP Management > AP Group** screen and select the **Profile Name** you just created.
- Place the Zyxel Device where there are minimum obstacles (such as walls and ceilings) between the Zyxel Device and the wireless client. Avoid placing the Zyxel Device inside any type of box that might block WiFi signals.

Bandwidth restriction controls the amount of network traffic that WiFi clients can consume. This prevents the WiFi clients from downloading too many movies and slowing down other devices on the network. See [Limit Network Bandwidth for Each WiFi Client](#) for more information on how to restrict network bandwidth for each WiFi client.

Unauthorized users have accessed my wireless LAN.

- WEP is extremely insecure. It is recommended that you use the strongest security mechanism that all the WiFi devices in your network support. WPA2, WPA2-Mix or WPA3 are recommended. See [Limit Network Bandwidth for Each WiFi Client](#) for how to change security settings for a WiFi network.
- Rogue AP is an unauthorized access point in the network that poses a security threat. See [Set Up Rogue AP Detection](#) for how to set up rogue AP detection.
- A MAC filter list blocks or allows a list of clients based on their MAC addresses, ensuring only authorized clients can access the network. See [Set Up a MAC Filter List](#) for more information about MAC filter.

The wireless security is not following the re-authentication timer setting I specified.

If a RADIUS server authenticates wireless stations, the re-authentication timer on the RADIUS server has priority over the setting in the Zyxel Device. Change the RADIUS server's configuration if you need to use a different re-authentication timer setting.

I forgot the WiFi password.

- If the Zyxel Device is connected to the NCC and registered, the WiFi password can be found in **Configure > Access points > SSID advanced settings > Choose the SSID** in the NCC portal.

- If the Zyxel device is in standalone mode, you can change the WiFi password by going to **Configuration > Edit SSID Profile > Edit Security Profile** in the Web Configurator, selecting **Personal**, and entering the new password in the **Pre-Shared Key** field.

I cannot import a certificate into the Zyxel Device.

- 1 For **My Certificates**, you can import a certificate that matches a corresponding certification request that was generated by the Zyxel Device. You can also import a certificate in PKCS#12 format, including the certificate's public and private keys.
- 2 You must remove any spaces from the certificate's filename before you can import the certificate.
- 3 Any certificate that you want to import has to be in one of these file formats:
 - Binary X.509: This is an ITU-T recommendation that defines the formats for X.509 certificates.
 - PEM (Base-64) encoded X.509: This Privacy Enhanced Mail format uses lowercase letters, uppercase letters and numerals to convert a binary X.509 certificate into a printable form.
 - Binary PKCS#7: This is a standard that defines the general syntax for data (including digital signatures) that may be encrypted. A PKCS #7 file is used to transfer a public key certificate. The private key is not included. The Zyxel Device currently allows the importation of a PKS#7 file that contains a single certificate.
 - PEM (Base-64) encoded PKCS#7: This Privacy Enhanced Mail (PEM) format uses lowercase letters, uppercase letters and numerals to convert a binary PKCS#7 certificate into a printable form.
 - Binary PKCS#12: This is a format for transferring public key and private key certificates. The private key in a PKCS #12 file is within a password-encrypted envelope. The file's password is not connected to your certificate's public or private passwords. Exporting a PKCS #12 file creates this and you must provide it to decrypt the contents when you import the file into the Zyxel Device.

Note: Be careful not to convert a binary file to text during the transfer process. It is easy for this to occur since many programs use text files by default.

26.6 Resetting the Zyxel Device

If you cannot access the Zyxel Device by any method, try restarting it by turning the power off and then on again. If you still cannot access the Zyxel Device by any method or you forget the administrator password(s), you can reset the Zyxel Device to its factory-default settings. Any configuration files or shell scripts that you saved on the Zyxel Device should still be available afterwards.

Use the following procedure to reset the Zyxel Device to its factory-default settings. This overwrites the settings in the startup-config.conf file with the settings in the system-default.conf file.

Note: This procedure removes the current configuration.

- 1 Make sure the Power LED is on and not blinking.
- 2 Press the **RESET** button and hold it until the Power LED begins to blink. (This usually takes about ten seconds.)

- 3 Release the **RESET** button, and wait for the Zyxel Device to restart.

You should be able to access the Zyxel Device in standalone mode using the default settings.

26.7 Getting More Troubleshooting Help

Search for support information for your model at www.zyxel.com for more troubleshooting suggestions.



APPENDIX A

Zyxel Account Authentication

Overview

There are several ways to log into Zyxel Web Portals, such as Nebula, Circle, SecuReporter, and so on. At the time of writing, the available login methods are listed below.

- [Google or Apple Account Login](#) (Google or Apple)
- [Microsoft Entra ID](#)
- [Passkey](#) (fingerprint, Face ID or PIN)

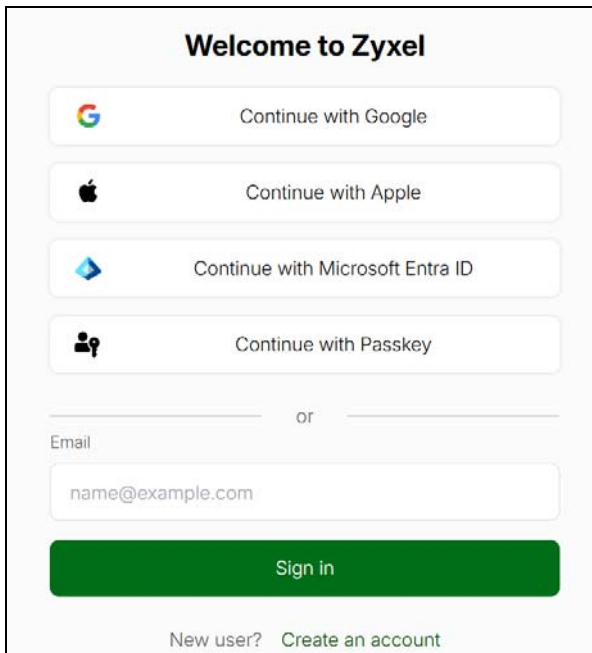

The screenshot shows a login interface titled "Welcome to Zyxel". It features four social login buttons: "Continue with Google" (with the Google logo), "Continue with Apple" (with the Apple logo), "Continue with Microsoft Entra ID" (with the Microsoft logo), and "Continue with Passkey" (with a person icon). Below these is a separator line with the word "or". Underneath is an "Email" input field containing "name@example.com" and a green "Sign in" button. At the bottom, there is a link for "New user? Create an account".

Google or Apple Account Login

Zyxel Web Portals support logging in with Google or Apple accounts. This section shows you how to:

- [Continue with Google](#)
- [Continue with Apple](#)

However, there are a few limitations. If you want to switch from email and password login to Google or Apple account login, the system will prompt you to confirm the change. You must accept this prompt to use your Google or Apple account for future logins.

For example, if you already have a Zyxel Account and want to use **Continue with Google** so you can log in with your Google credentials, you can follow the steps below to switch the login method to Google.

Note: Once you have successfully logged in with a Google or Apple account, you can only use this method for future logins. If you try to log in with email and password after a successful login with your Google or Apple account, the login will fail, and you will receive an email notifying you that your login method has been switched to Google or Apple sign-in. Contact customer support if you want to undo this change.

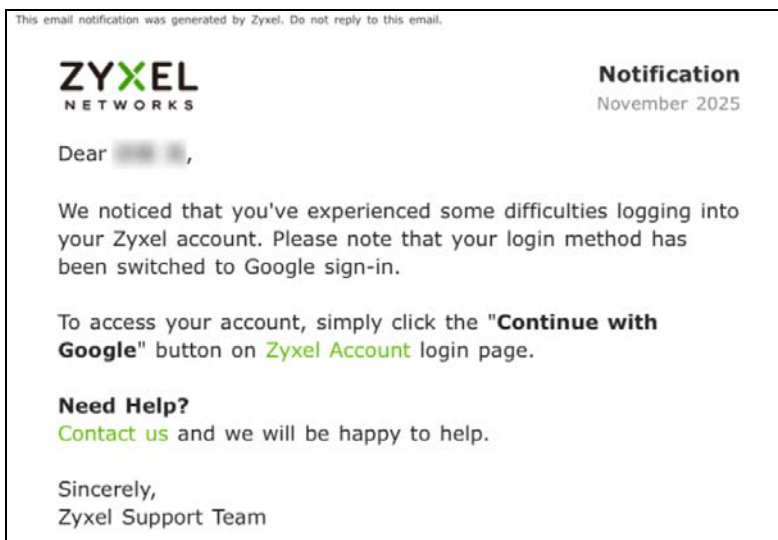

Note: Configure two-factor authentication, password changes, and password recovery through your Google or Apple account. You cannot use organization-wide two-factor authentication when you log in using a Google or Apple account.

Continue with Google

- 1 On the Zyxel Account login page, click **Continue with Google**.

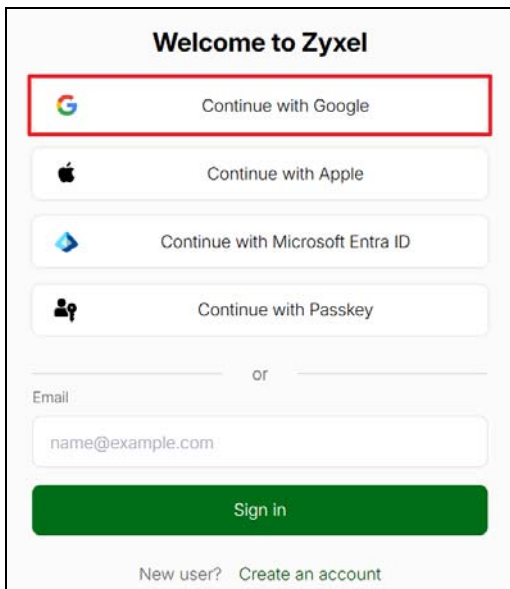

- 2 Log in to your Google account. If you are already logged in, follow the system prompt and select an account you want to log in with.

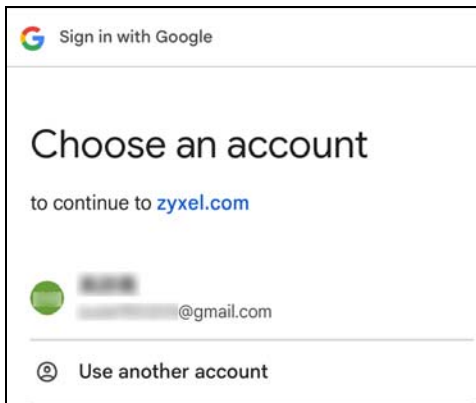

- 3 Click **Continue** so your future login method will be **Continue with Google** only.

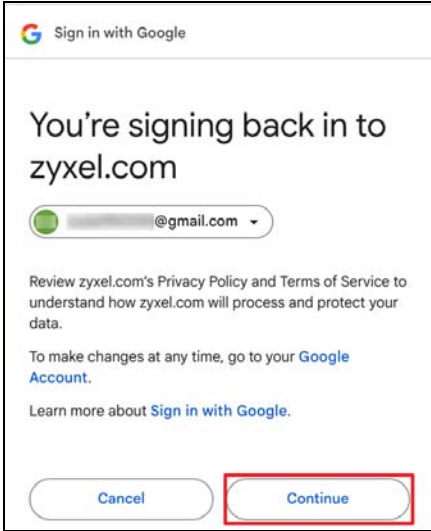

Continue with Apple

- 1 On the Zyxel Account login page, click **Continue with Apple**.

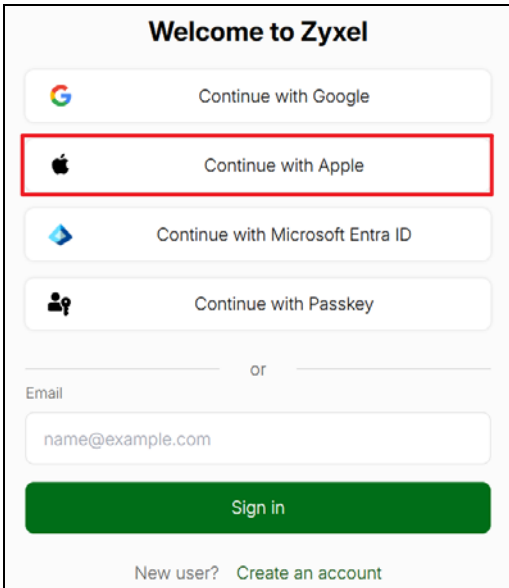

- 2 Log into your Apple account.

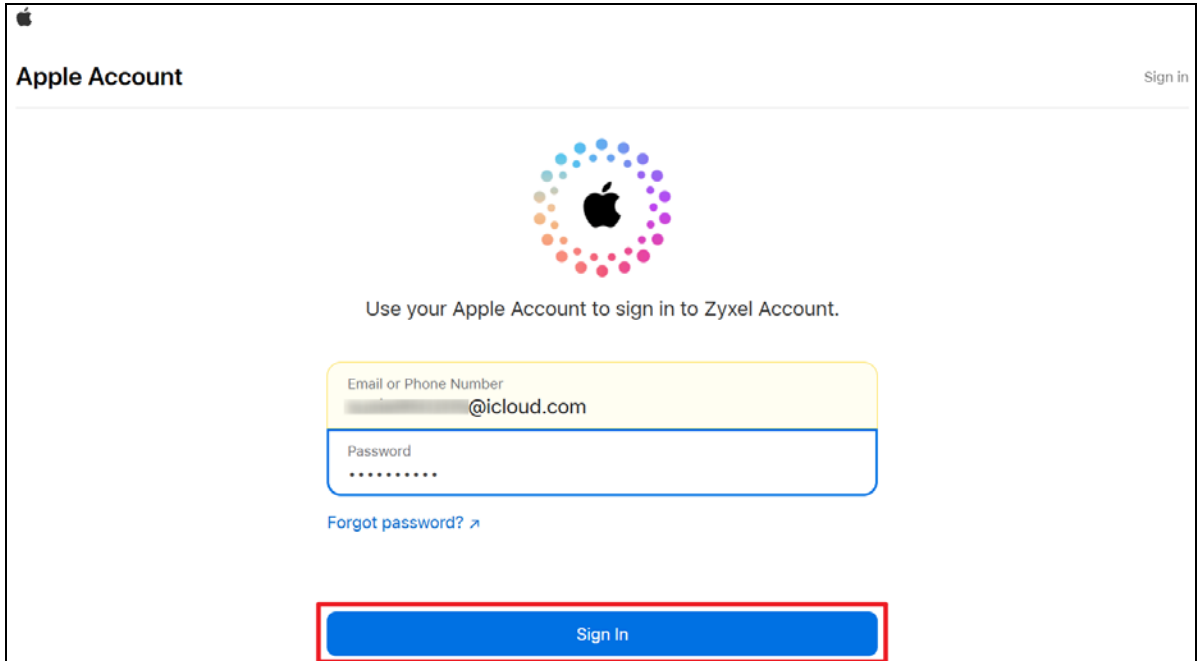

The screenshot shows the Apple Account sign-in interface. At the top left is the Apple logo, and at the top right is the text "Sign in". Below the header is a large Apple logo composed of colorful dots. The text "Use your Apple Account to sign in to Zyxel Account." is centered. There are two input fields: "Email or Phone Number" containing a redacted email address followed by "@icloud.com", and "Password" with masked characters. A link "Forgot password? ↗" is below the password field. At the bottom, a blue "Sign In" button is highlighted with a red rectangular border.

- 3 Click **Continue** so your future login method will be **Continue with Apple** only.

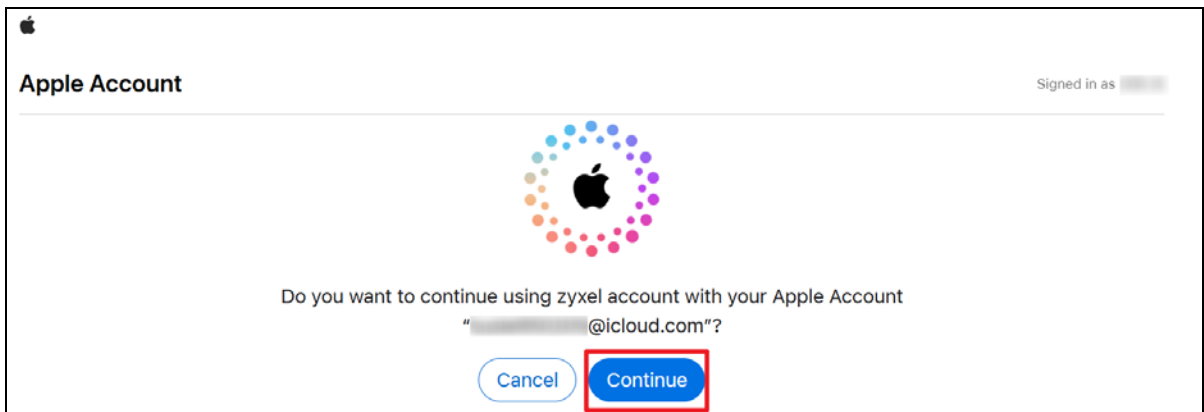

The screenshot shows a confirmation dialog from Apple. At the top left is the Apple logo, and at the top right is "Signed in as" followed by a redacted name. Below the header is a large Apple logo composed of colorful dots. The text "Do you want to continue using zyxel account with your Apple Account" is centered, followed by "“ [redacted]@icloud.com ”?". At the bottom, there are two buttons: "Cancel" and "Continue". The "Continue" button is highlighted with a red rectangular border.

Microsoft Entra ID

Microsoft Entra ID is Microsoft’s cloud-based identity and access management service that allows organizations to manage user accounts, and enables Single Sign-On (SSO) across all platforms. Entra ID reduces password management overhead and improves security by ensuring that only authenticated users can access the Zyxel Account.

The following tutorial is for administrators, most likely the IT team in your organization, to configure the initial settings before general users can log in using this method.

In this section, we show you how to:

- [Enable Microsoft Entra ID](#)
- [Create Enterprise Application](#)

- [Configure Single Sign-on](#)
- [Configure **Attributes & Claims**](#)
- [Download and Upload the Metadata File](#)
- [Verify the Entra ID Configuration](#)
- [Assign Users and Groups](#)
- [Deploy Entra ID Settings](#)

Before You Begin

You must have the following to set up Entra ID sign-in.

- Microsoft Entra ID administrator account with global administrator privileges.
- Zyxel Account using email and password sign-in method.

Enable Microsoft Entra ID

- 1 Go to your [Zyxel Account](#).

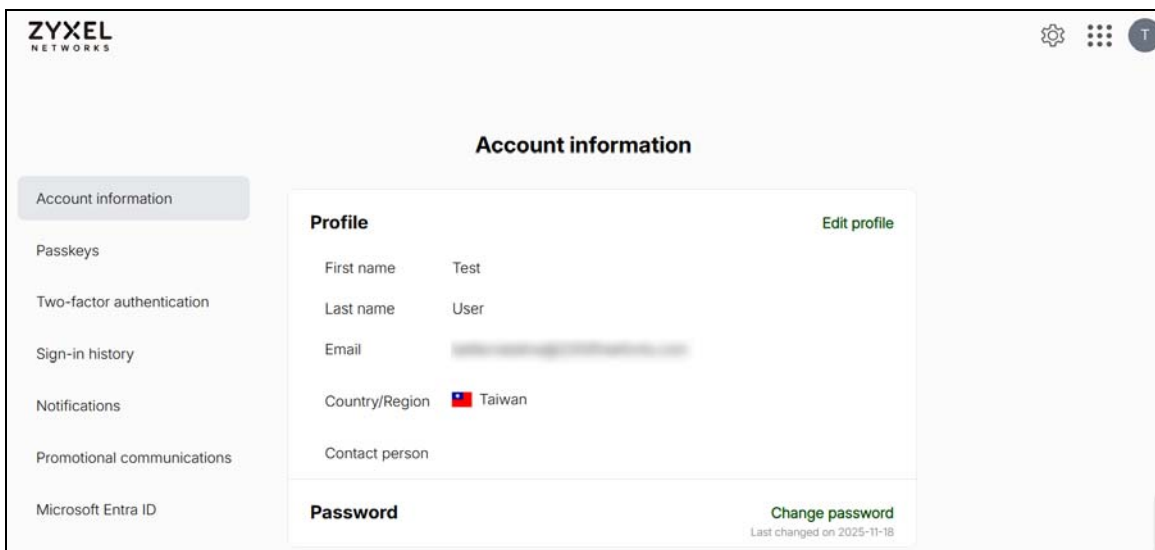

Alternatively, navigate to **Manage Account** under the profile picture when you are in another Zyxel platform.

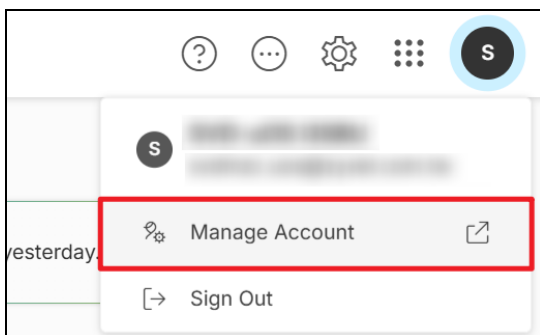

- 2 Go to the Microsoft Entra ID tab, and click the **Set up Microsoft Entra ID** switch to the right.

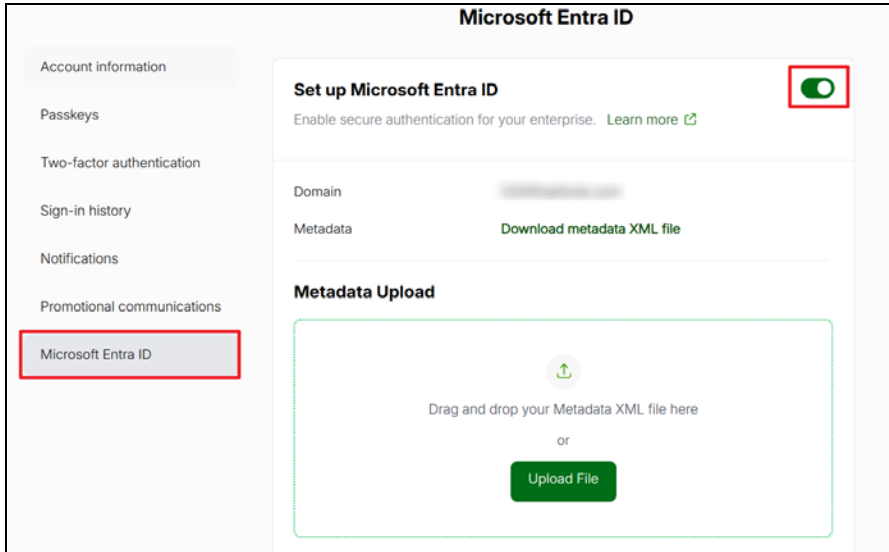

- 3 Click **Download metadata XML file**. You will need this later.

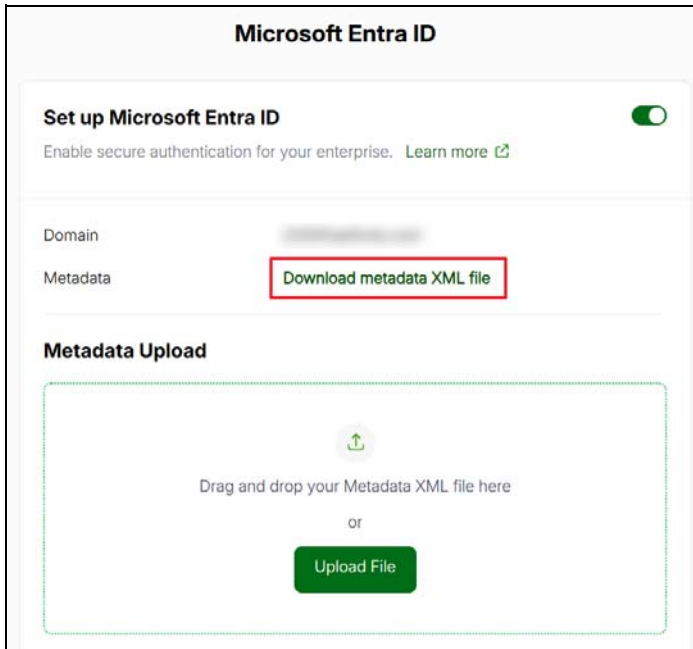

Create Enterprise Application

- 1 Go to the [Microsoft Entra admin center](#). Sign in with a Microsoft Entra tenant account that has global administrator privileges.

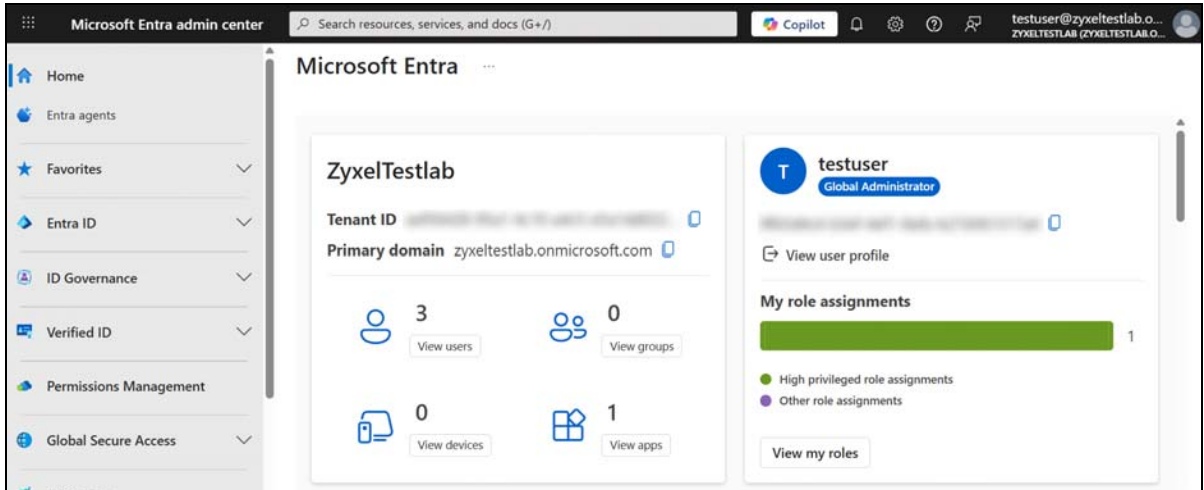

Note: A personal Microsoft account (such as Outlook.com) will not work. If your company uses Microsoft 365, a valid account would be something like username@yourcompany.com.

Note: To know if your account has global administrator privileges, go to **Users > your user name > Assigned roles > Role** to view your role.

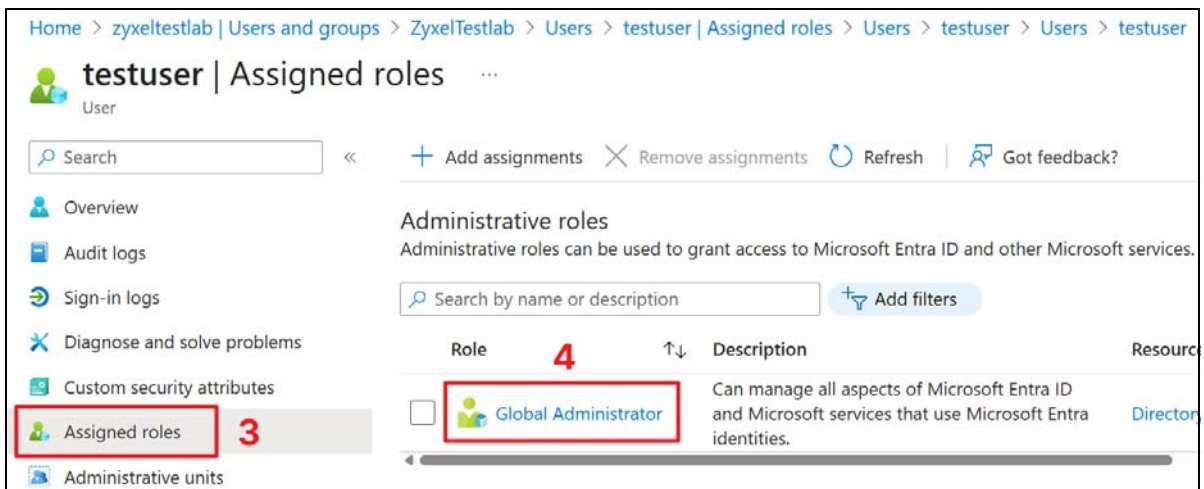
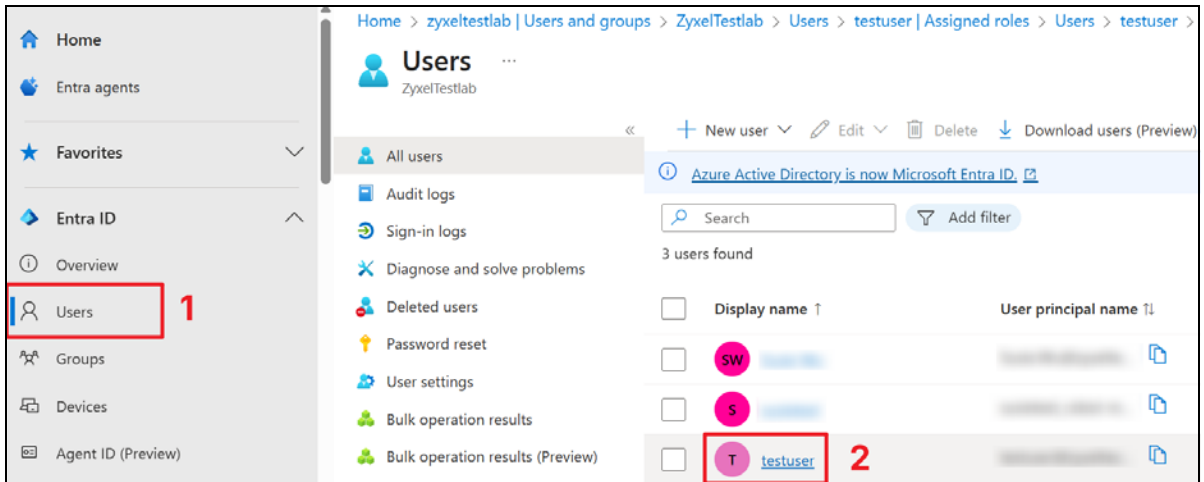

- 2 Go to **Enterprise apps > All applications**, and click **New application**.

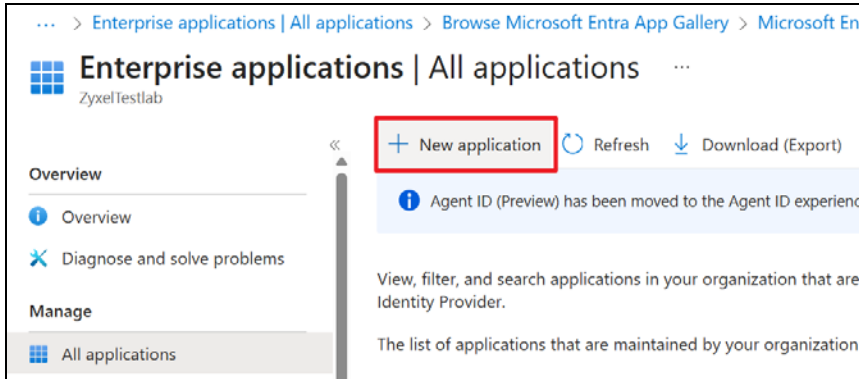

- 3 Click **Create your own application**.

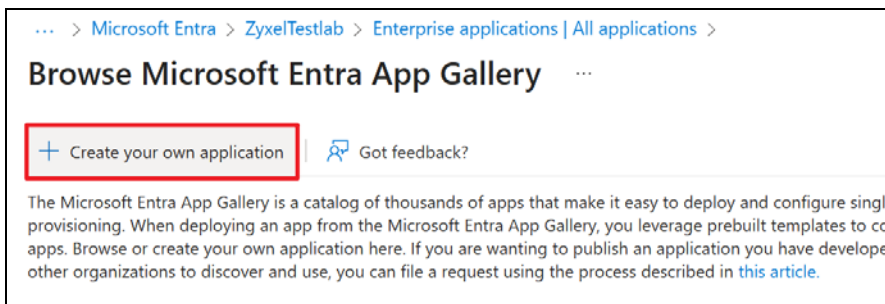

- 4 Enter a name for your application. Select **Integrate any other application you don't find in the gallery**. Then, click **Create**.

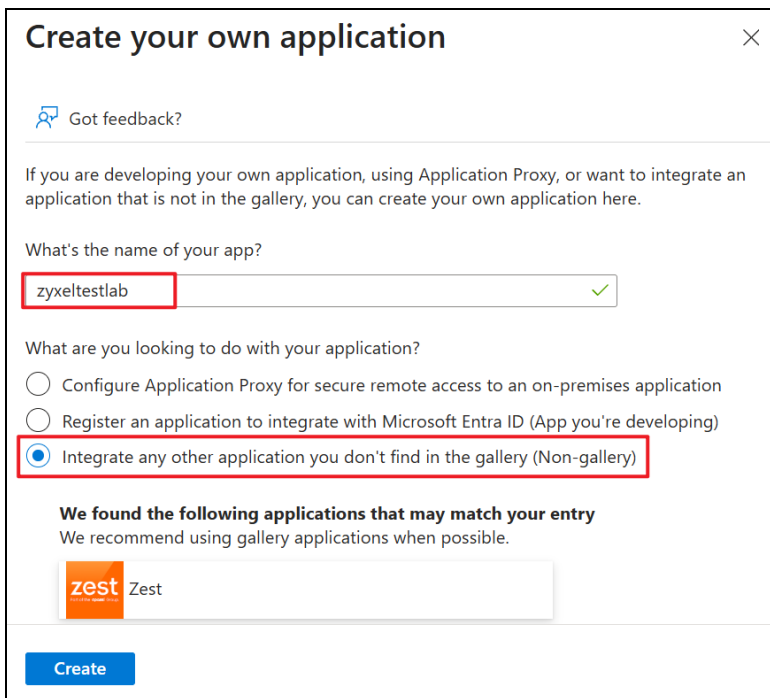

Note: The application name must not exceed 93 characters and cannot contain the following characters: '<', '>', ',', '&', '%'.

Configure Single Sign-on

Next, you need to configure single sign-on, which allows you to use the same login criteria on different platforms.

1 Select **Set up single sign on**.

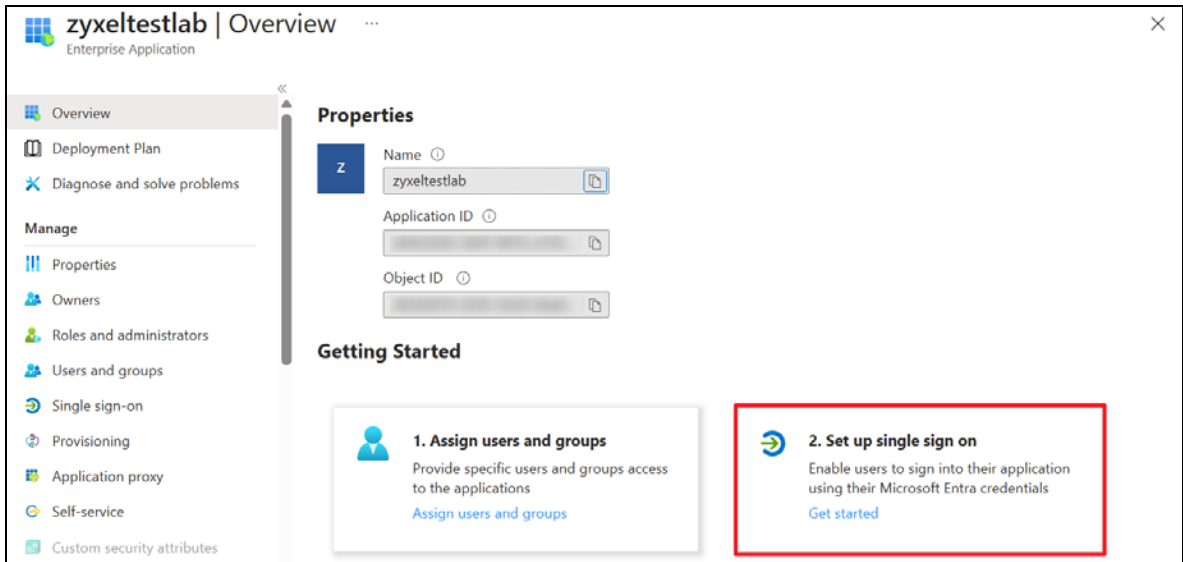

2 Select **SAML** as the sign-on method.

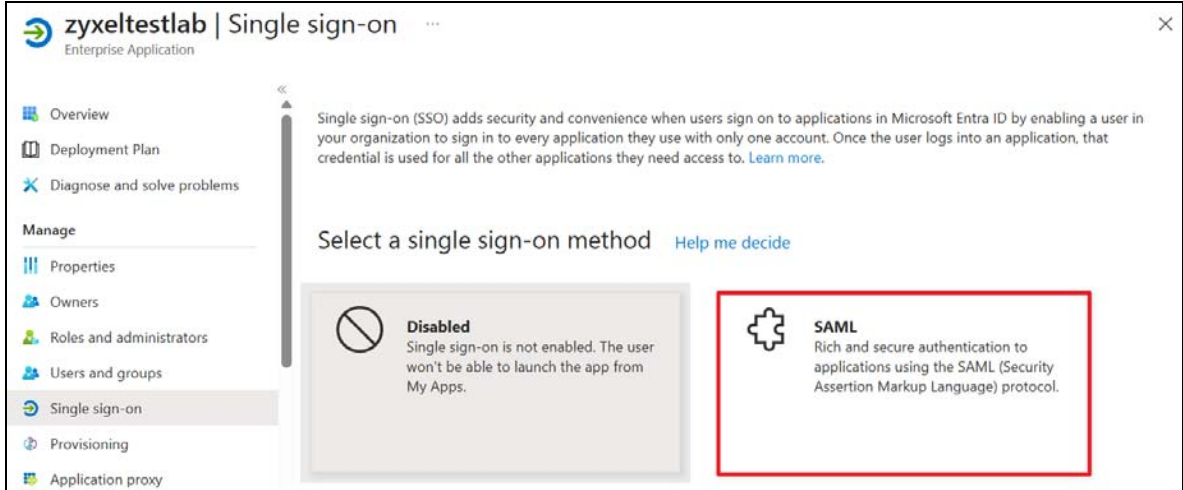

3 Upload the metadata XML file you downloaded in step 3 of the **Enable Microsoft Entra ID** section.

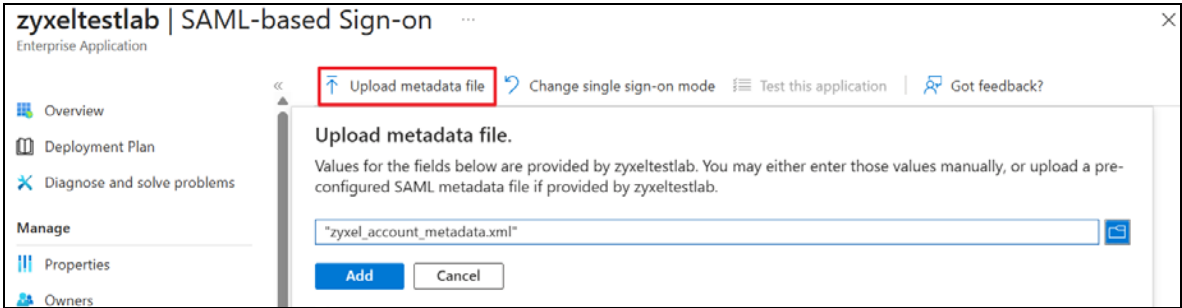

Configure Attributes & Claims

Define **Attributes & Claims** at the application level. These claims tell the portal what user information to expect during login. All users assigned to this application automatically inherit these claims. You only need to configure this once.

- 1 Click **Edit** to configure this section.

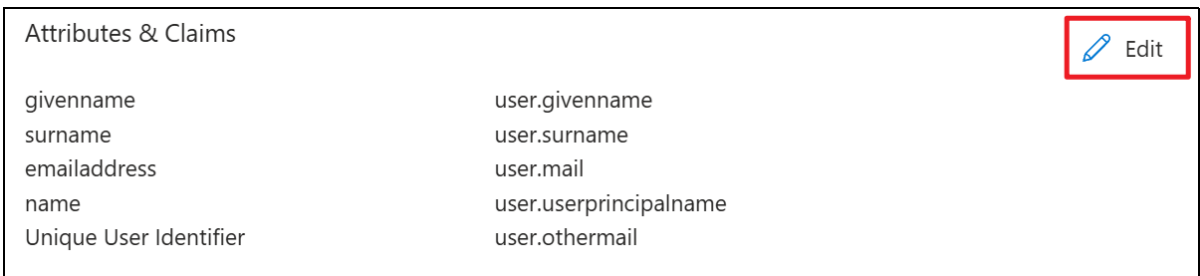

The default value and descriptions of each claim are shown in the table below.

CLAIM	DEFAULT VALUE	OPTIONAL / REQUIRED	DESCRIPTION
givenname	user.givenname	Optional	User's first name.
surname	user.surname	Optional	User's last name.
emailaddress	user.mail	Optional	User's primary email.
name	user.userprincipalname	Optional	User's login ID or display name shown in the portal.
Unique User Identifier	user.othermail	Required	Unique internal ID used by the portal to identify the user.

Note: Most Zyxel portals accept the system's default Attributes & Claims. When integrating Entra ID login with other portals, check if they require any specific attribute mappings.

- 2 Click the claim that you want to edit to enter the **Manage claim** screen, or delete any claims you do not need.

Required claim		
Claim name	Type	Value
Unique User Identifier (Name ID)	SAML	user.othermail [nameid-f... ***

Additional claims		
Claim name	Type	Value
http://schemas.xmlsoap.org/ws/2005/05/identity/claims/emailadd...	SAML	user.mail Delete
http://schemas.xmlsoap.org/ws/2005/05/identity/claims/givenname	SAML	user.givenname ***
http://schemas.xmlsoap.org/ws/2005/05/identity/claims/name	SAML	user.userprincipalname ***
http://schemas.xmlsoap.org/ws/2005/05/identity/claims/surname	SAML	user.surname ***

Manage claim ✕

Save Discard changes | Got feedback?

Name *

Namespace

Choose name format

Source * Attribute Transformation Directory schema extension

Source attribute *

Claim conditions
 Advanced SAML claims options

Download and Upload the Metadata File

- 1 On the **Single sign-on** page, go to the **SAML Certificates** section, and download the **Federation Metadata XML** file.

[Upload metadata file](#) | [Change single sign-on mode](#) | [Test this application](#) | [Got feedback?](#)

3 SAML Certificates

Token signing certificate [Edit](#)

Status: Active

Thumbprint: [Redacted]

Expiration: 11/18/2028, 2:27:58 PM

Notification Email: [Redacted].com

App Federation Metadata Url: <https://login.microsoftonline.com/eef56428-95a...>

Certificate (Base64): [Download](#)

Certificate (Raw): [Download](#)

Federation Metadata XML: [Download](#)

Verification certificates (optional) [Edit](#)

Required: No

Active: 0

Expired: 0

- Open your Zyxel Account page. Click **Upload File**, and select the file you downloaded in the previous step. Then, click **Save**.

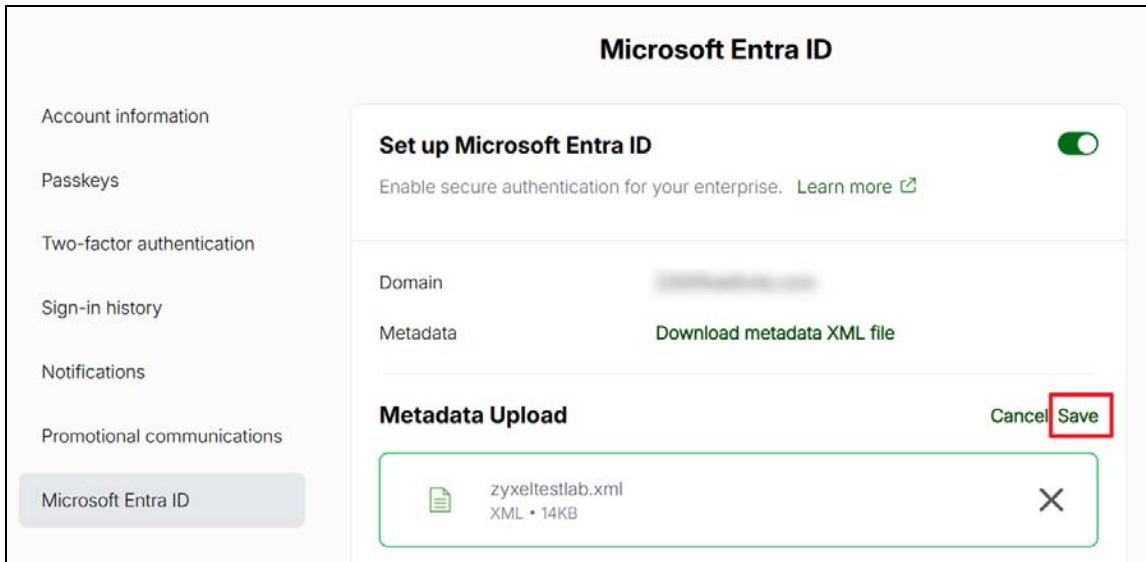
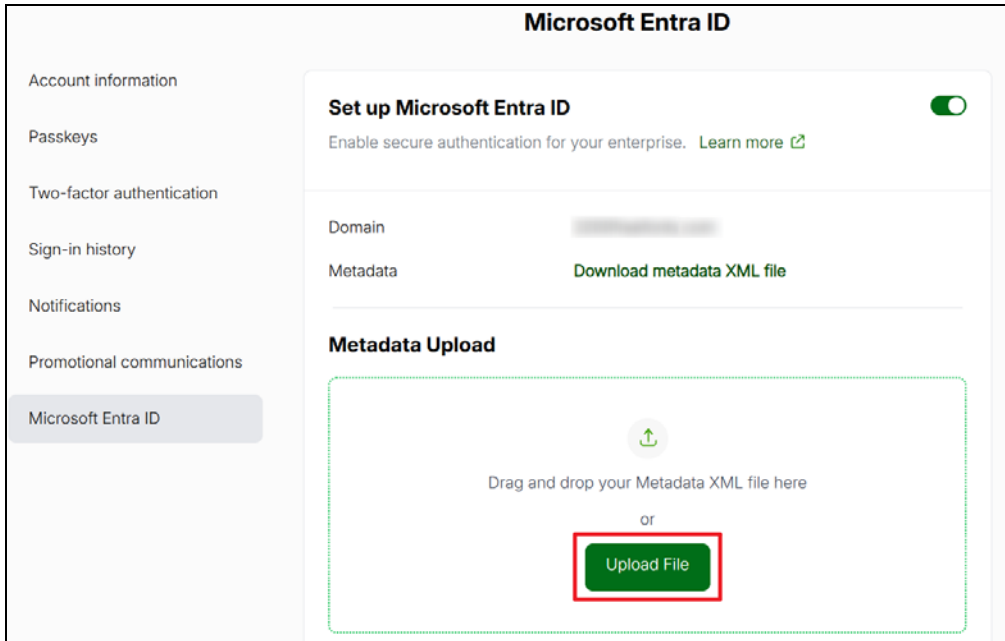

Verify the Entra ID Configuration

- Click **Verify** to open a new verification page.

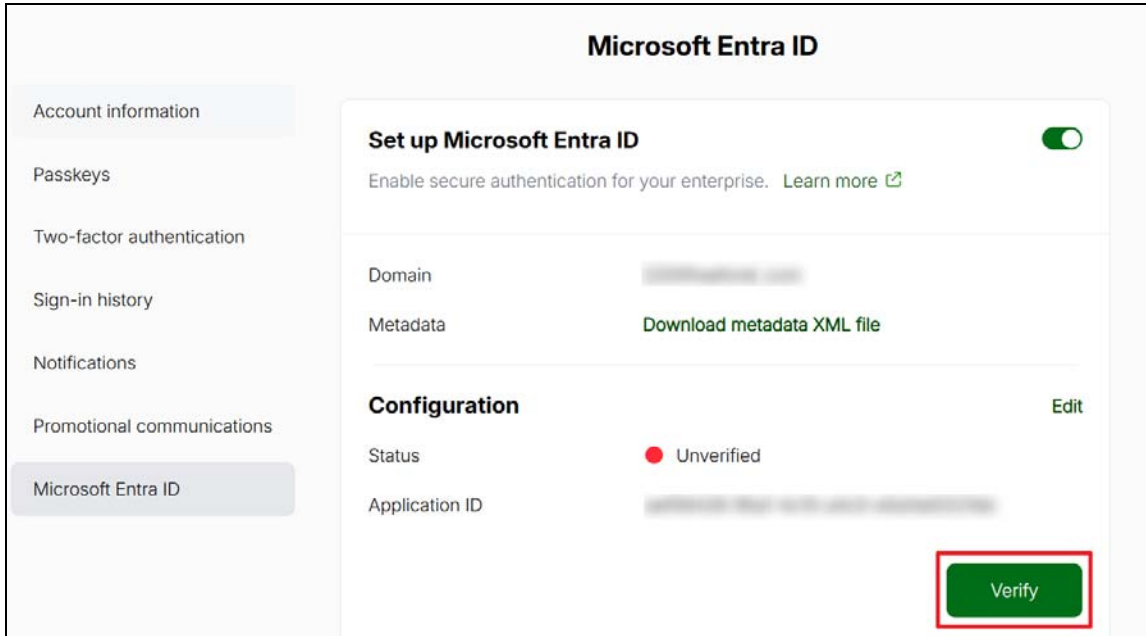

- 2 Sign in using the same email as your Zyxel Account.

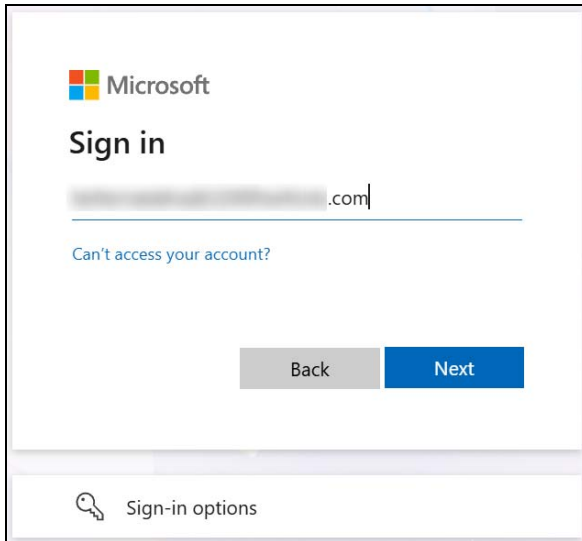

- 3 Upon successful login, you will see a verification success page with a Deployment code.

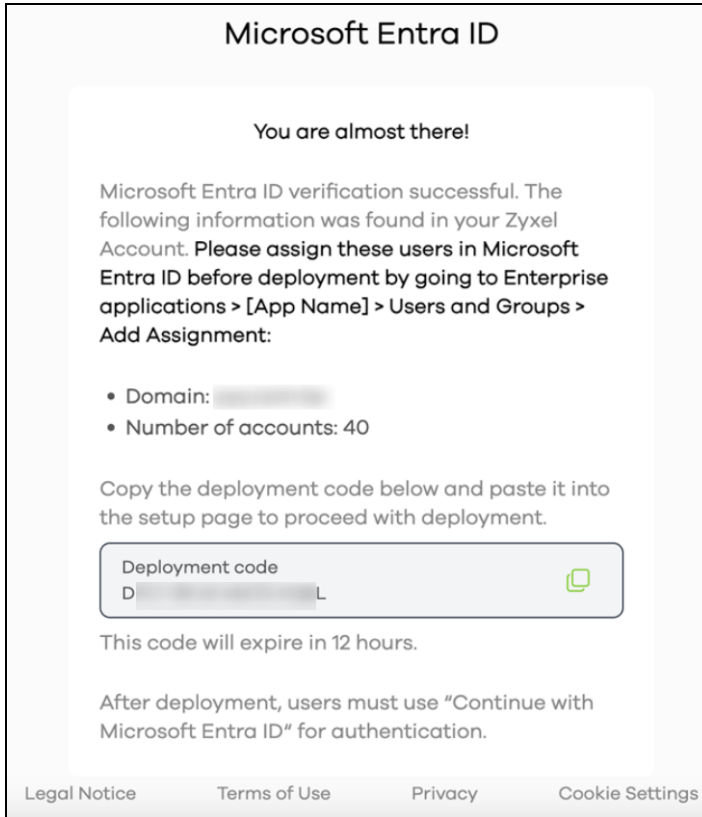

- 4 The status will change to **Verified** on the Entra ID Settings page.

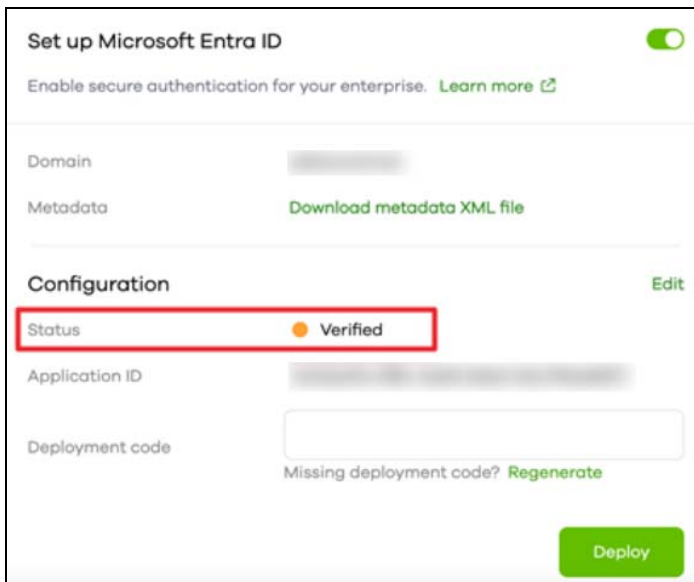

Assign Users and Groups

- 1 Return to the Microsoft Entra admin center. Go to **Enterprise apps**, and click on the application that you created earlier.

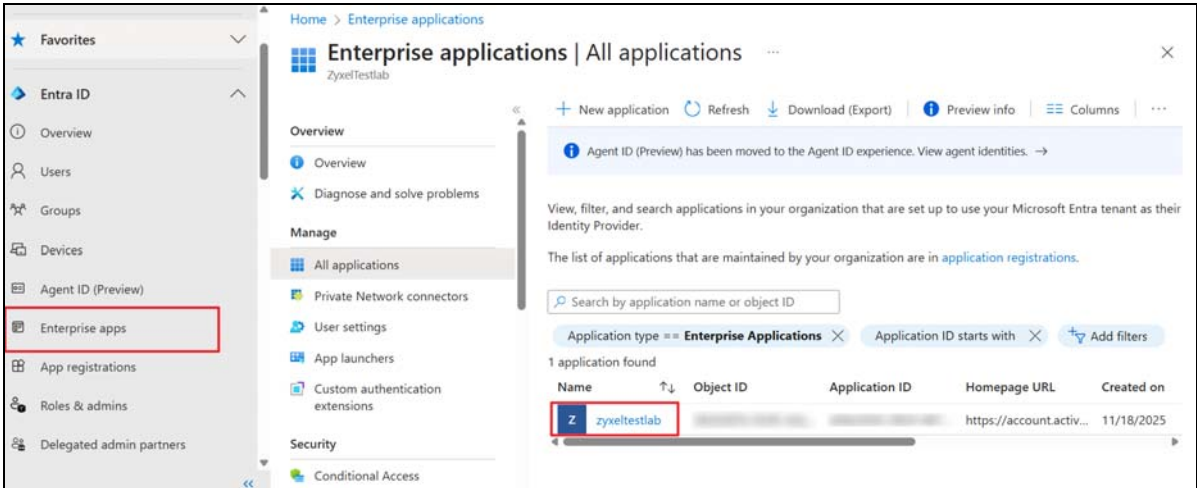

2 Click **Assign users and groups**.

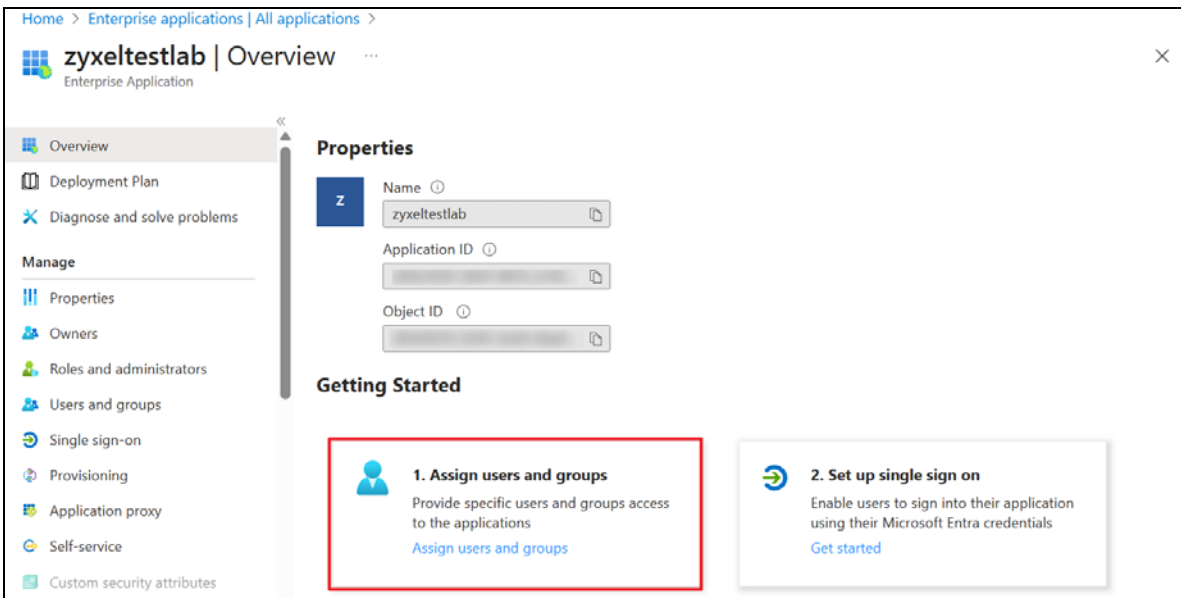

3 Click **Add user/group**.

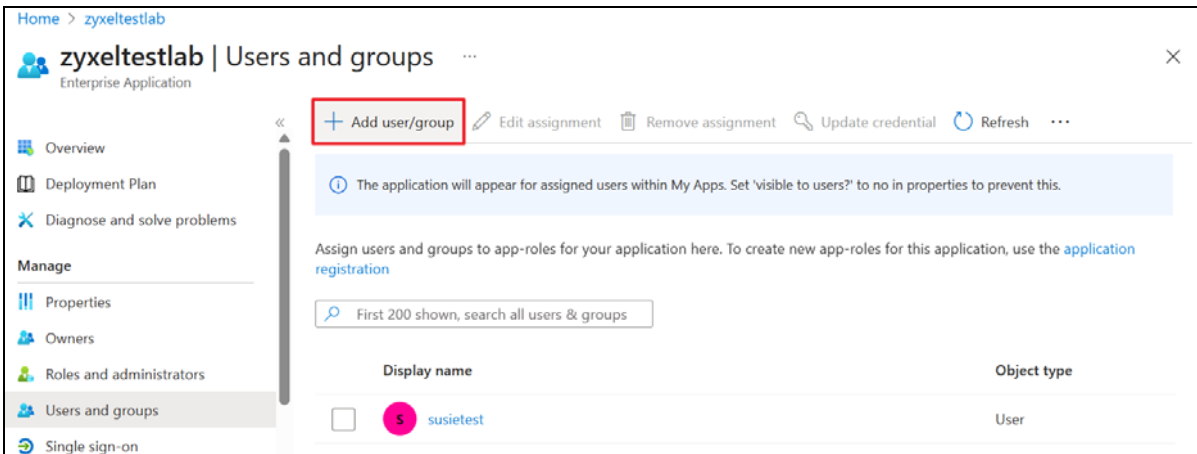

- 4 Select which users can use Microsoft Entra ID to access the company platform. Click **Select**.

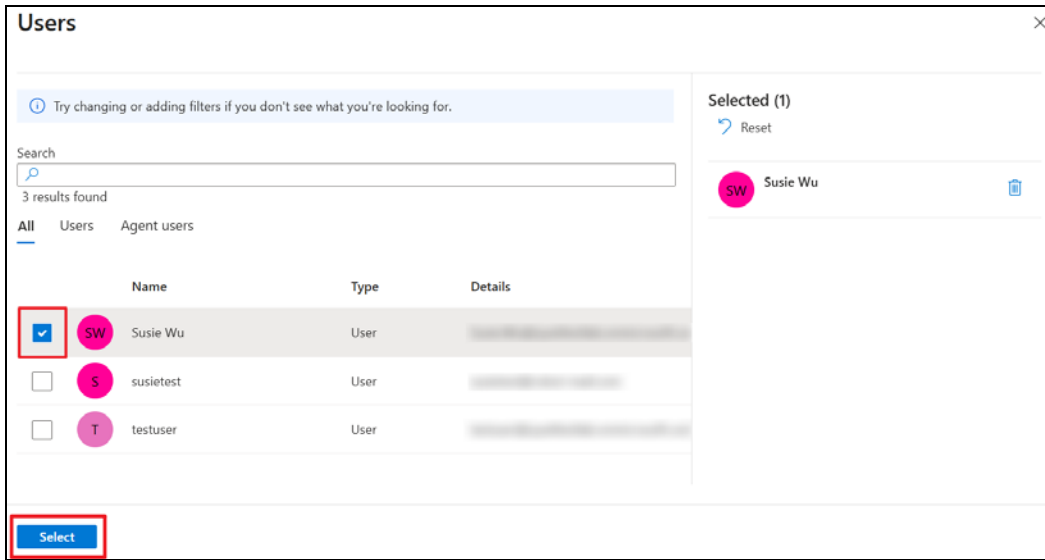

- 5 Click **Assign** to assign a role to the users.

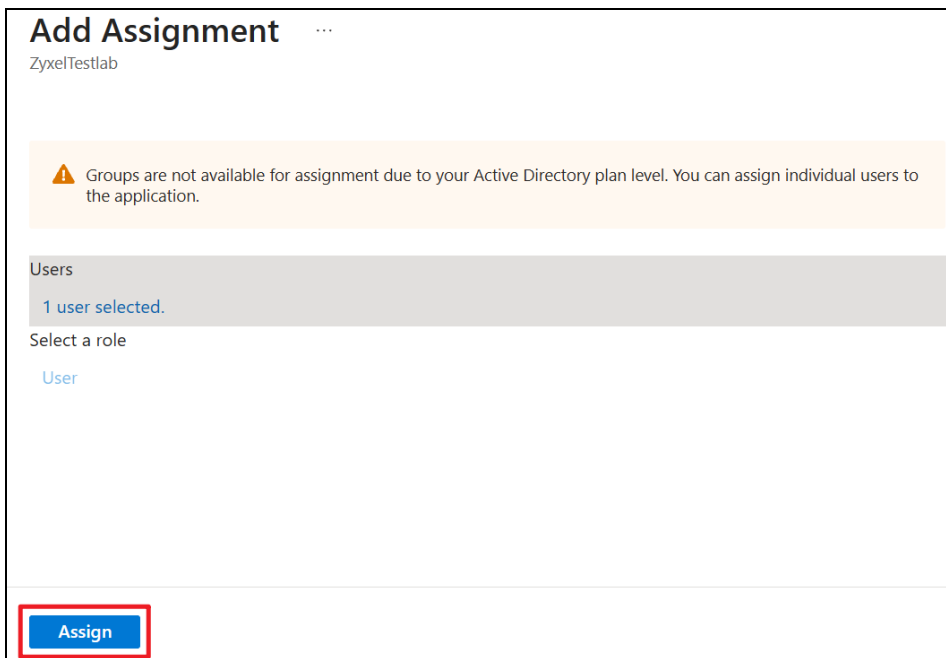

- 6 The users that are added to this application will display on the **Users and groups** screen.

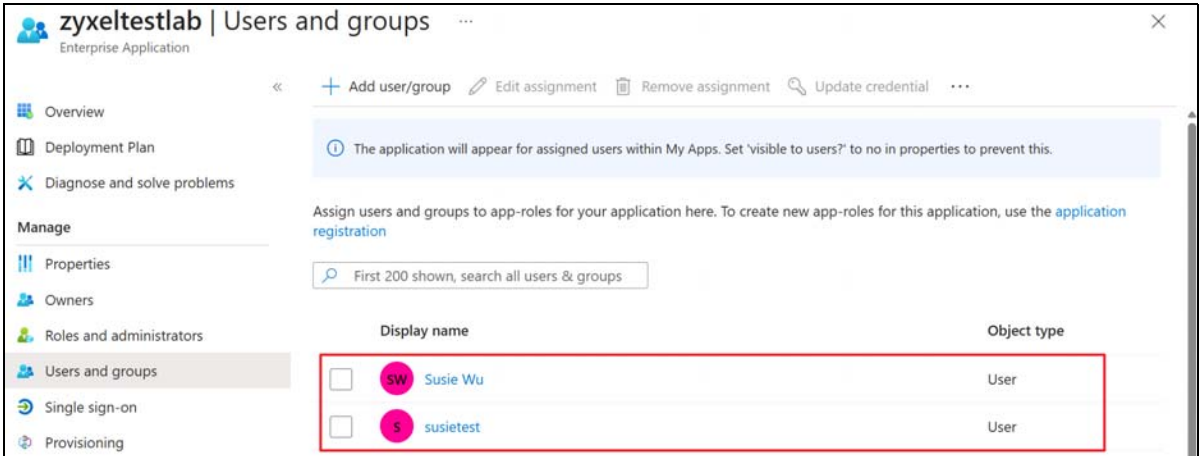

Deploy Entra ID Settings

- 1 Copy the Deployment code from step 3 of the **Verify the Entra ID Configuration** section, and paste it in the **Deployment code** field on your Zyxel Account page. Then, click **Deploy**.

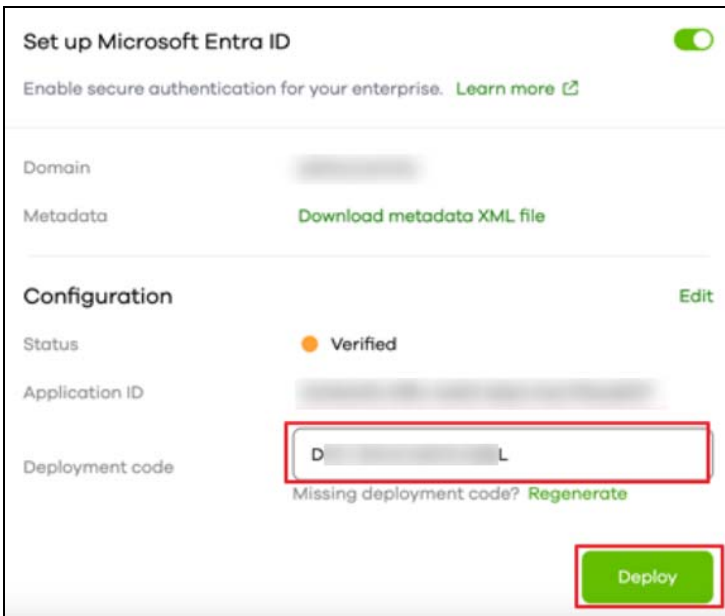

- 2 Selected users will receive a notification email.

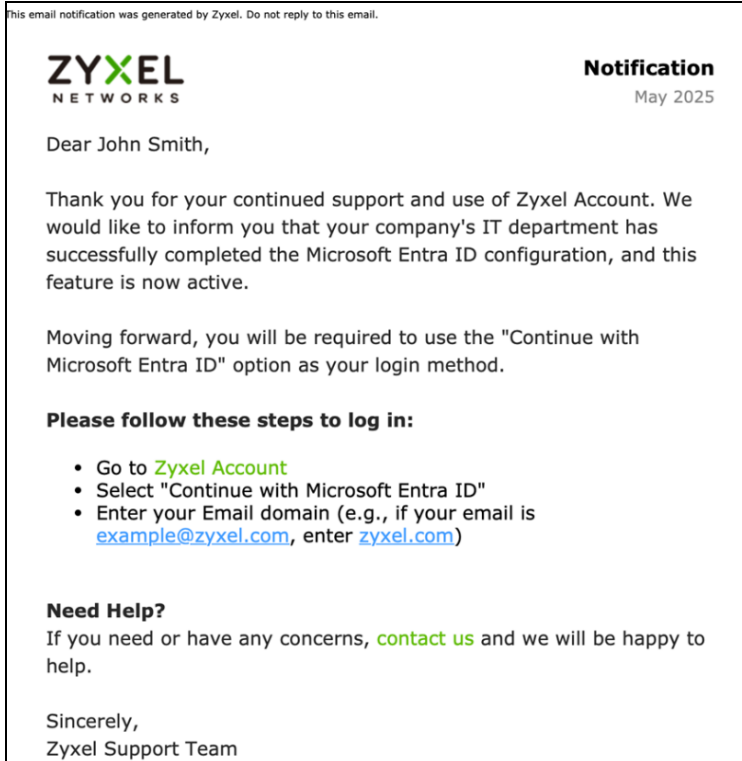

3 You as the administrator will also receive a confirmation email.

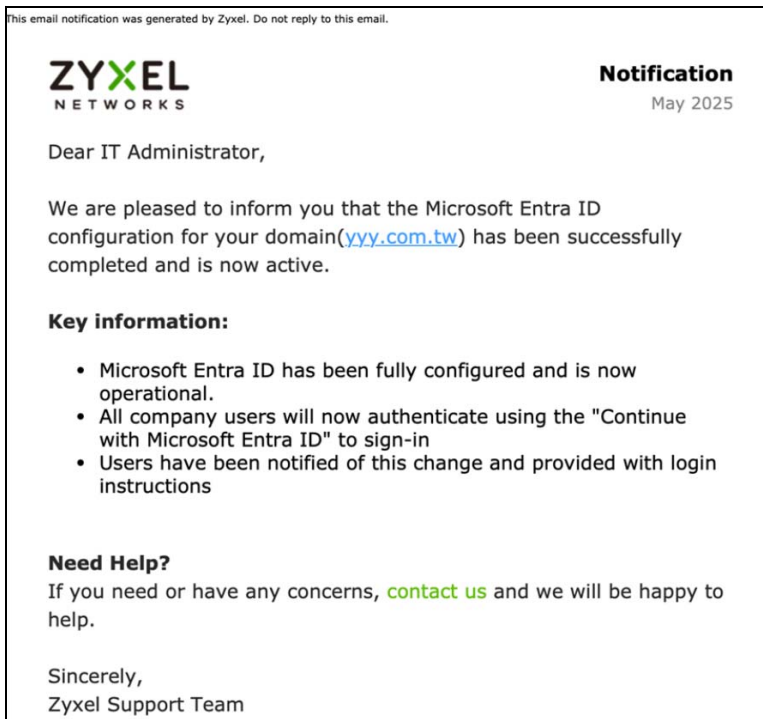

4 On the Entra ID Settings page, the status will now display **Working**.

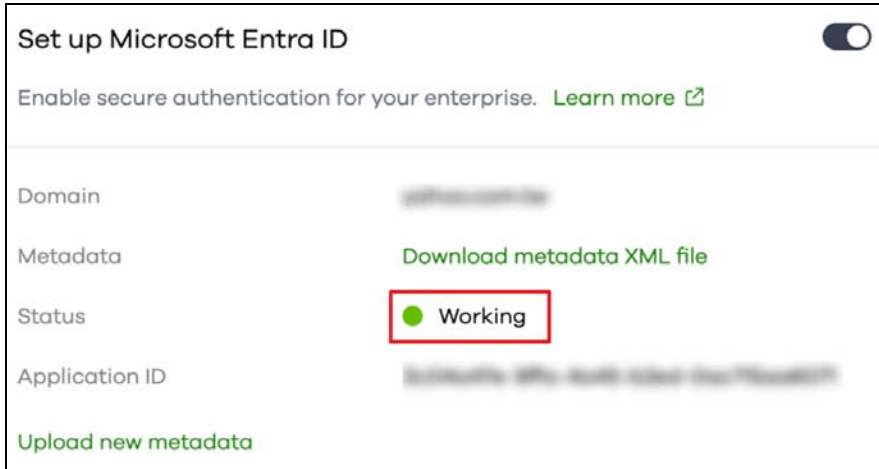

Passkey

In this section, we show you how to:

- [Add a Passkey Using Windows Computers](#)
- [Add a Passkey Using Android Devices](#)
- [Add a Passkey Using Apple Devices](#)
- [Log in with a Passkey](#)

A passkey is a login method that lets you log into a Zyxel Web Portal using the same way you unlock your computer or mobile device – fingerprint, Face ID, or PIN. You can use passkeys to log into Zyxel Web Portals, such as Nebula, Circle, SecuReporter, and so on.

When you create a passkey, your computer or mobile device generates two keys:

- Public key – stored on the Zyxel server.
- Private key – stored locally on your computer or mobile device.

Your device's PIN or biometrics (for example, fingerprint, Face ID) is used only to unlock the private key, and is only stored locally on your computer or mobile device.

Note: The passkey limit for every account is shown below.

Maximum number of passkeys	5
-----------------------------------	---

Note: The following are the minimum computer or mobile device operating system and web browser version requirements to run passkey at the time of writing:

COMPUTER OS VERSION	MOBILE DEVICE OS VERSION	WEB BROWSER VERSION
Windows 10 or later	iOS 16 or later	Chrome 109 or later
macOS 13 Ventura or later	iPadOS 16 or later	Safari 16.1 or later
ChromeOS 109 or later	Android 9 or later	Edge 109 or later

Add a Passkey Using Windows Computers

- 1 Log into a Web Portal, click the Account icon at the top right corner, select **Manage account**.

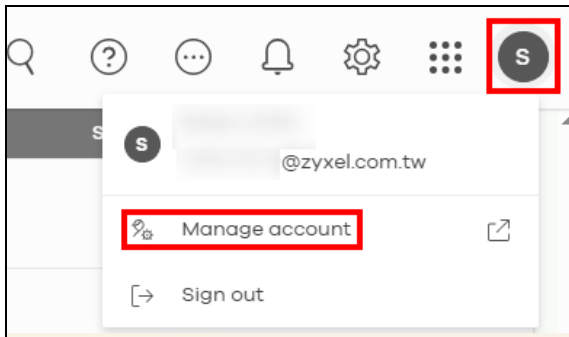

- 2 Go to the **Passkeys** tab and click **Add Passkey**.

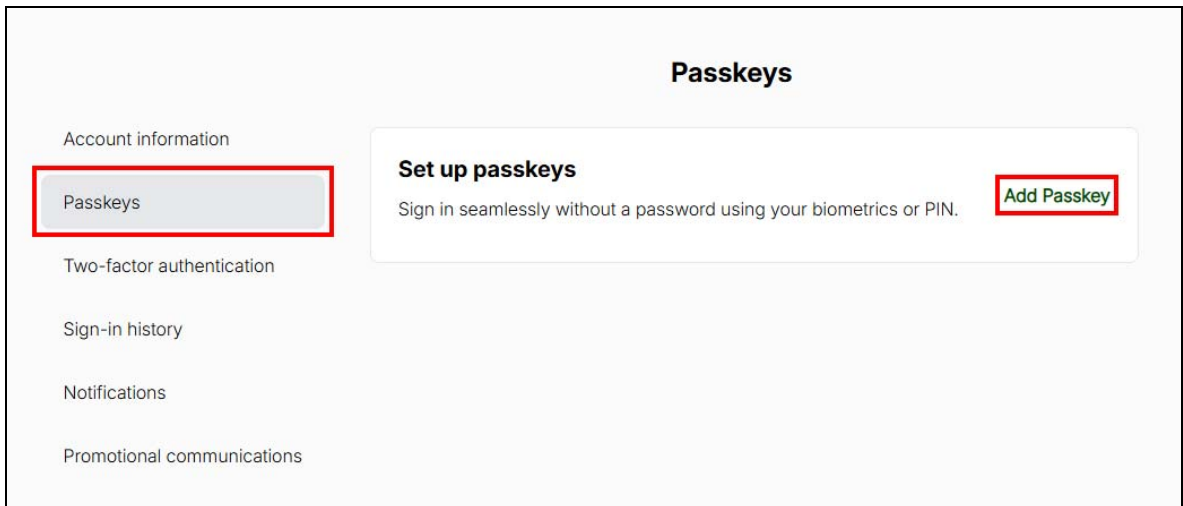

- 3 Click **Create**.

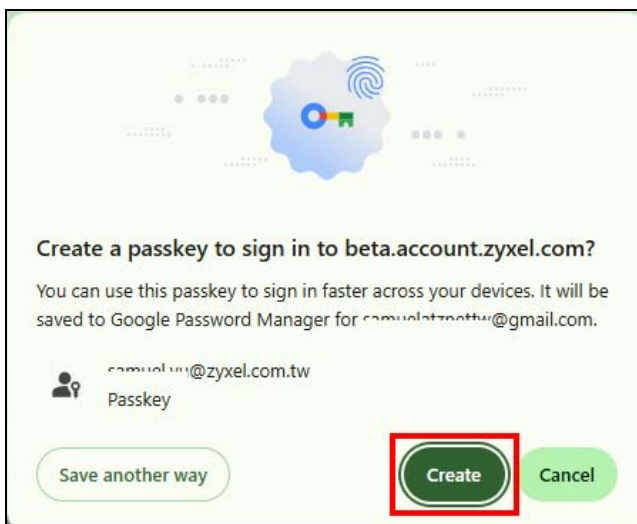

- Your computer will prompt you to authenticate using biometrics (fingerprint or facial recognition) or your PIN.

Note: Your computer must have one of the following Windows Hello sign-in options enabled: PIN, fingerprint, or facial recognition. To set up these sign-in options on your Windows computer, go to **Settings > Accounts > Sign-in options**.

Note: For biometrics, your computer must have a fingerprint reader or camera for facial recognition. If not, select the PIN option instead.

Note: If you lose your PIN, do the following:

- In Windows:
Go to **Settings > Accounts > Sign-in options > PIN (Windows Hello) > I forgot my PIN**. You will be prompted to re-authenticate using your Microsoft Account password or recovery options.
- In macOS:
Use your Apple ID to reset the passcode, or restore from another Apple device where you are still signed in.
- For Cloud Password Managers:
If you forget it, you can usually log in again using your master password or account recovery flow.

- Authenticate using the PIN or biometrics that you already set on your device.

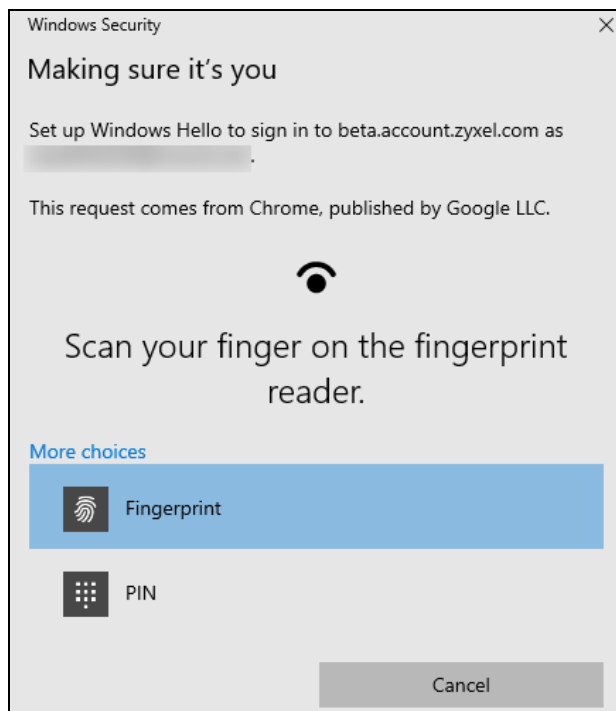

- The passkey is now saved on this Windows computer. Name your passkey after completing the PIN authentication or biometrics authentication, and then click **OK**.

Add Passkey name

Windows Hello-fingerprint

OK

- 7 A **New passkey added!** email will be sent to the same email address used for your Zyxel Account.

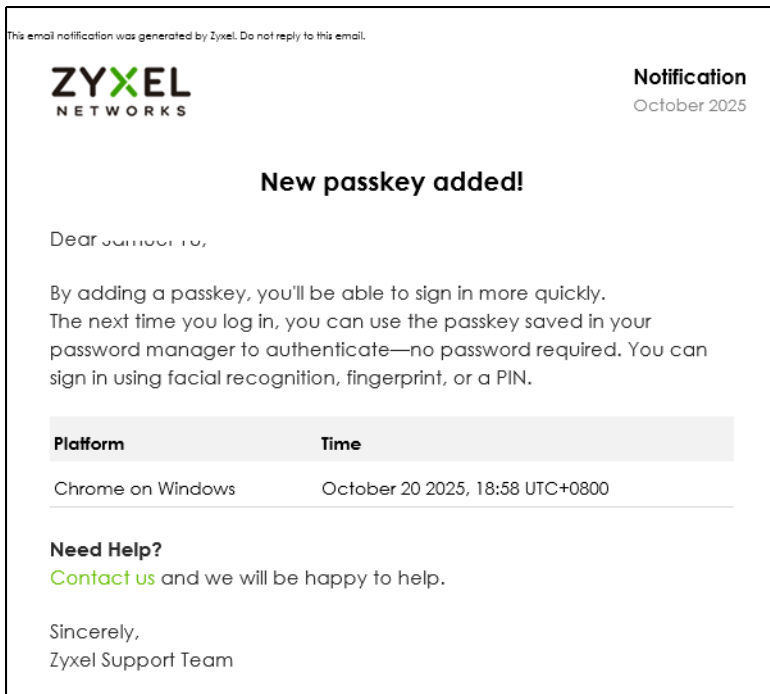

- 8 You can view all your saved passkeys on the **Manage account > Passkeys** page. Select the passkey that matches the Windows computer you are using to sign in.

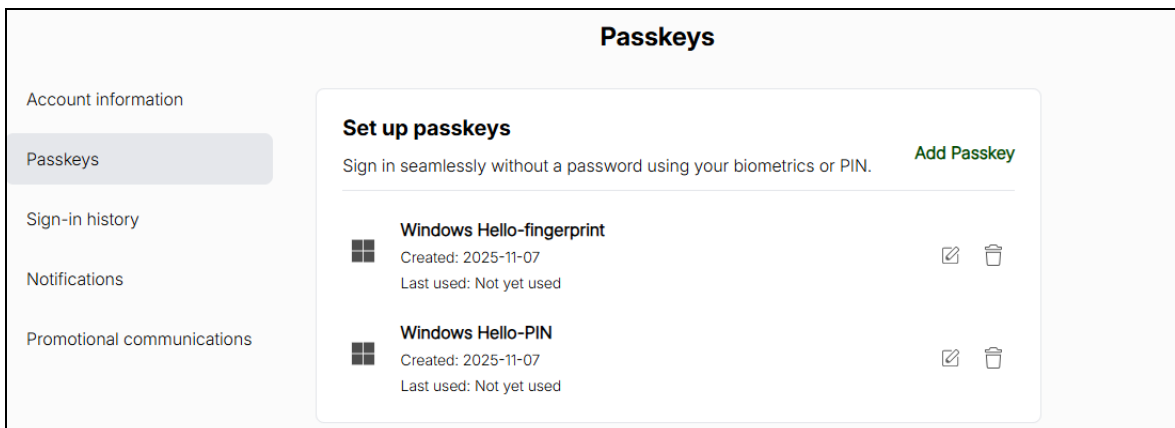

Add a Passkey Using Android Devices

- 1 Log into your Zyxel Account, click **Add Passkey**. Click **Set up screen lock**, the system will lead you to **Settings > Lock screen and AOD > Screen lock and biometrics**.

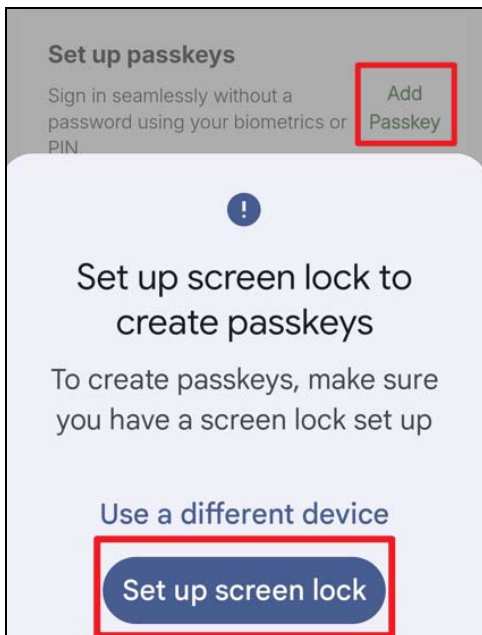

- 2 If you already have screen lock set up, click **Continue** to create a passkey.

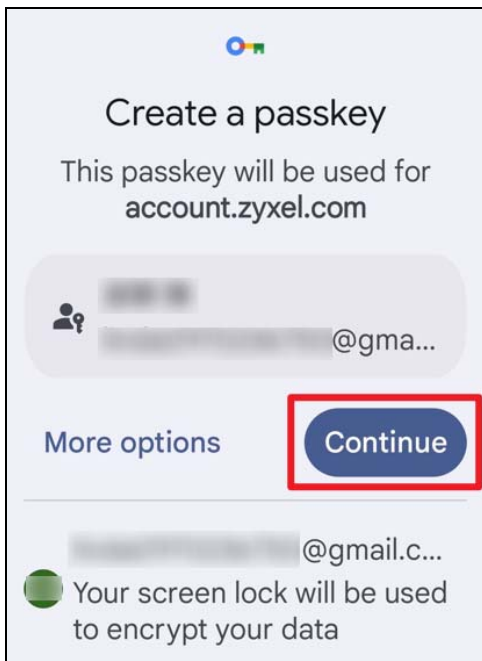

- 3 Authenticate using your fingerprint, face recognition, or screen lock PIN.

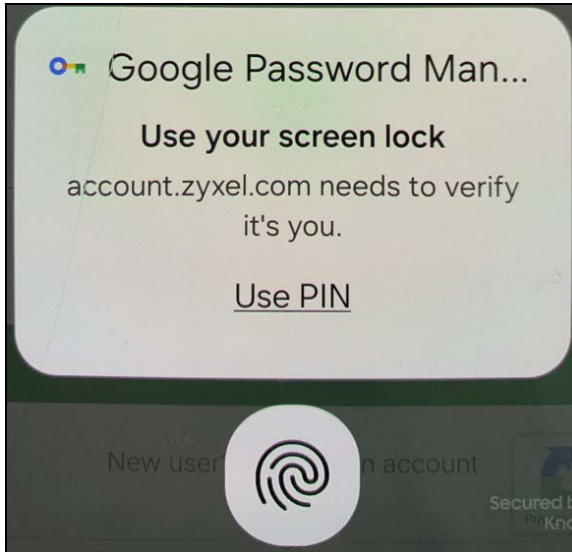

- 4 The passkey is now added and saved to your Google account.

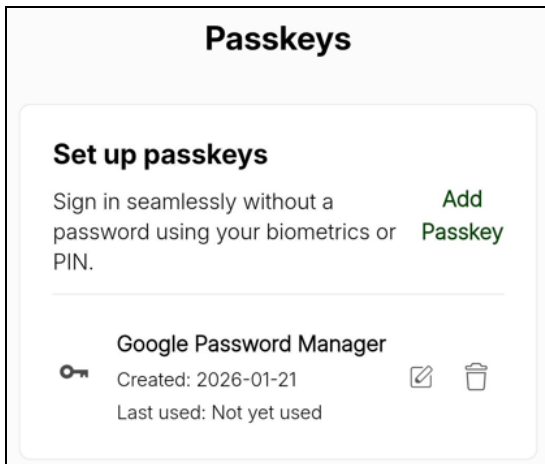

Add a Passkey Using Apple Devices

- 1 Log into your Zyxel Account, click **Add Passkey**. Click **Turn on iCloud Keychain** to enable iCloud Keychain.

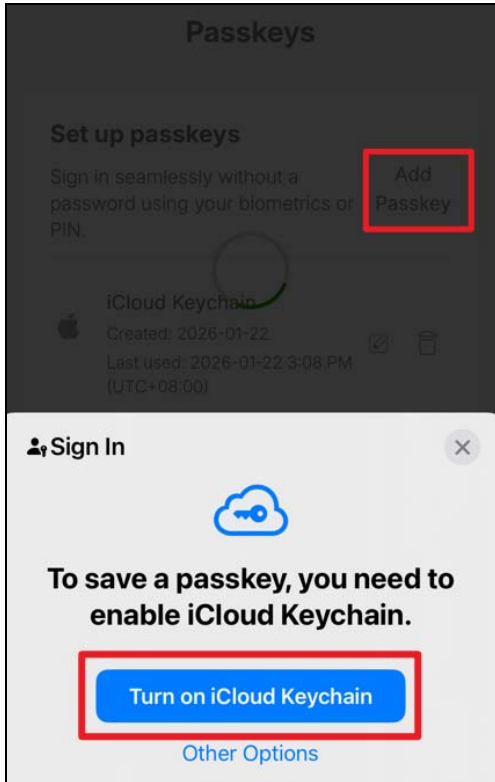

- 2 If your Apple device's iCloud Keychain is already on, click **Continue** to sign in with Face ID.

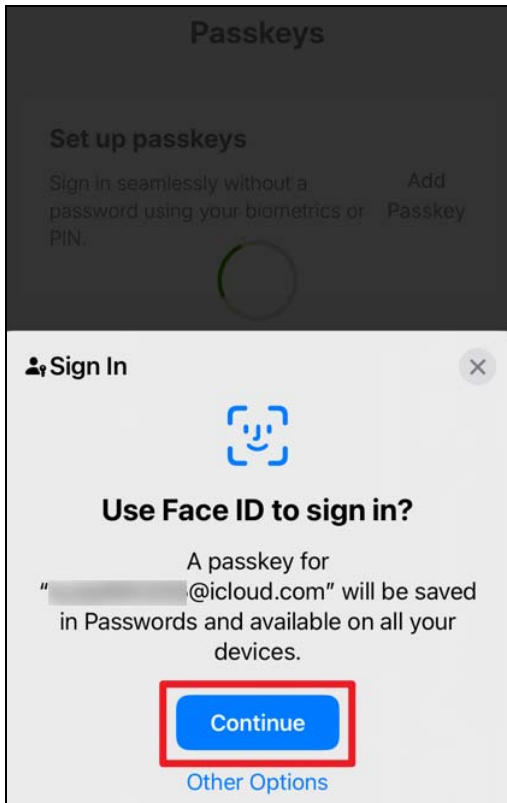

- The passkey is now added and saved to iCloud Keychain.

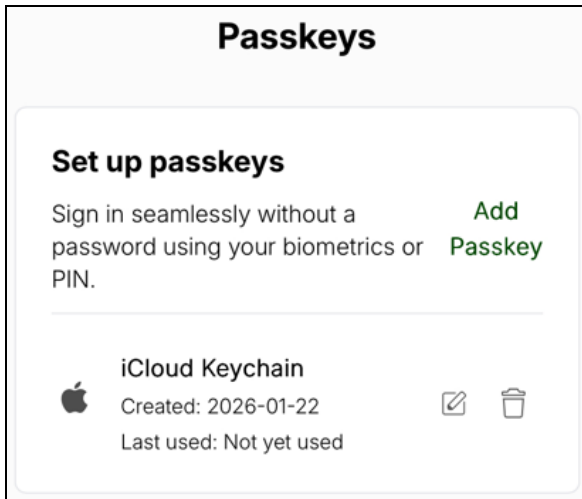

Log in with a Passkey

The passkey is stored locally on your computer or mobile device. If you have enabled cloud synchronization on your computer or mobile device, you can log in from other devices, but those devices must use the same operating system, such as Windows, Google (Android) or Apple. If not, you must log in using the same computer or mobile device where the passkey was registered.

- On the login screen, click **Continue with Passkey**.

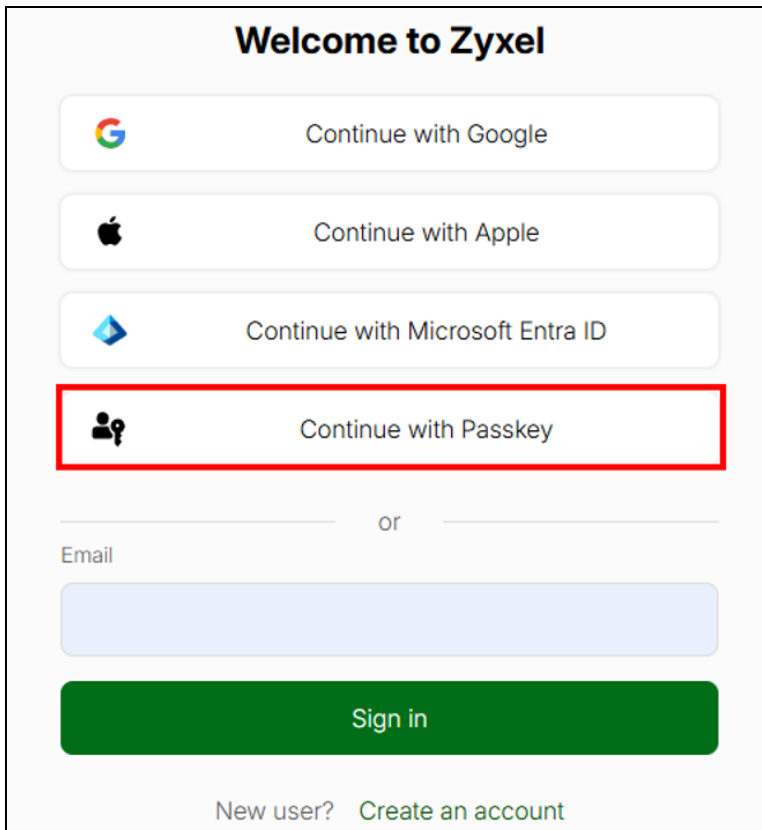

- 2 Select the account email you want to sign in with, and click **Next**.

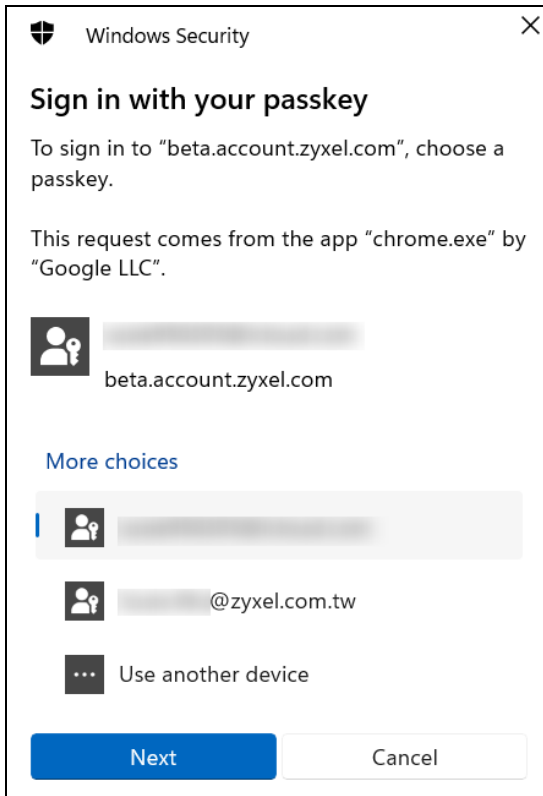

- 3 Complete the biometric authentication by using your device's fingerprint reader to scan your fingerprint, or camera to map your face, or by entering a PIN to log into the Zyxel Web Portal.

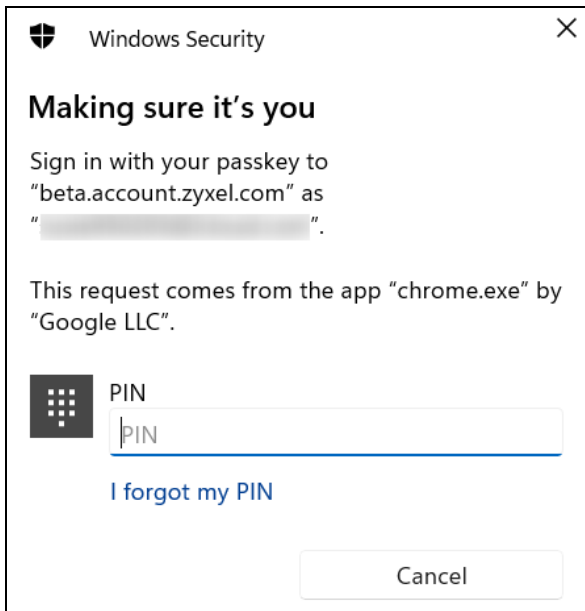

APPENDIX B

Importing a Certificate

When you connect to the Zyxel Device web configurator using HTTPS, a warning page “Your connection is not private” may show up. If you see this warning page, it indicates that your browser has failed to verify the Secure Sockets Layer (SSL) certificate, which opens an encrypted connection. You can ignore this message and proceed to the website.

This appendix shows you how to import a public key certificate into your web browser including Google Chrome, Microsoft Edge, and Mozilla Firefox.

Public key certificates are used by web browsers to ensure that a secure web site is legitimate. When a certificate authority such as VeriSign, Comodo, or Network Solutions, to name a few, receives a certificate request from a website operator, they confirm that the web domain and contact information in the request match those on public record with a domain name registrar. If they match, then the certificate is issued to the website operator, who then places it on the site to be issued to all visiting web browsers to let them know that the site is legitimate.

Many Zyxel products, such as the Zyxel Device, issue their own public key certificates. These can be used by web browsers on a LAN or WAN to verify that they are in fact connecting to the legitimate device and not one masquerading as it. However, because the certificates were not issued by one of the several organizations officially recognized by the most common web browsers, you will need to import the Zyxel-created certificate into your web browser and flag that certificate as a trusted authority.

Note: You can see if you are browsing on a secure website if the URL in your web browser’s address bar begins with `https://` or there is a sealed padlock icon () somewhere in the main browser window (not all browsers show the padlock in the same location).

Note: You need a certificate from a trusted Certification Authority (CA) for this Zyxel Device.

Importing a Certificate to Google Chrome and Microsoft Edge

The following example uses Google Chrome on Windows 10 Pro. You first have to store the certificate in your computer and then install it as a Trusted Root CA, as shown in the following tutorials.

The Importing process is quite similar between Google Chrome and Microsoft Edge. The following procedures in Google Chrome can apply the same way in Microsoft Edge.

- 1 Open Google Chrome browser. Click the three dots on the upper right corner. Choose **Settings**.

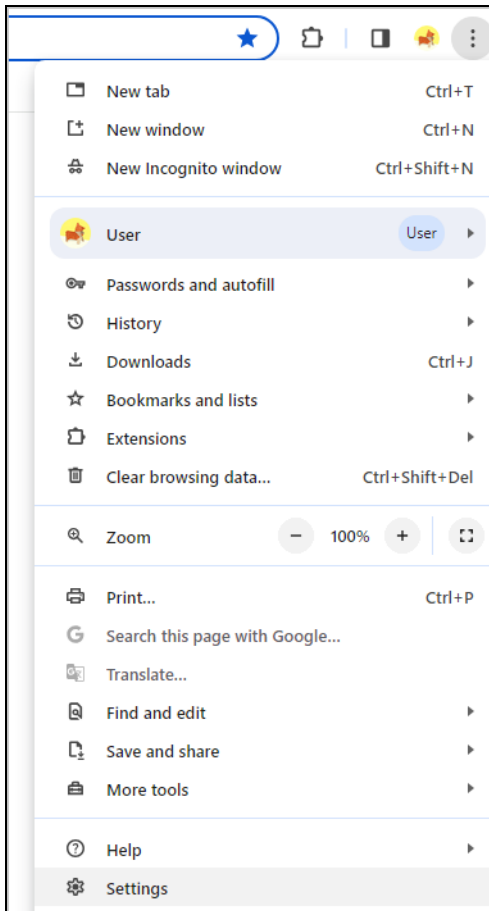

- 2 In Google Chrome, click **Privacy and security > Security > Manage certificates**. In Microsoft Edge, click **Privacy, search, and services > Manage certificates**.

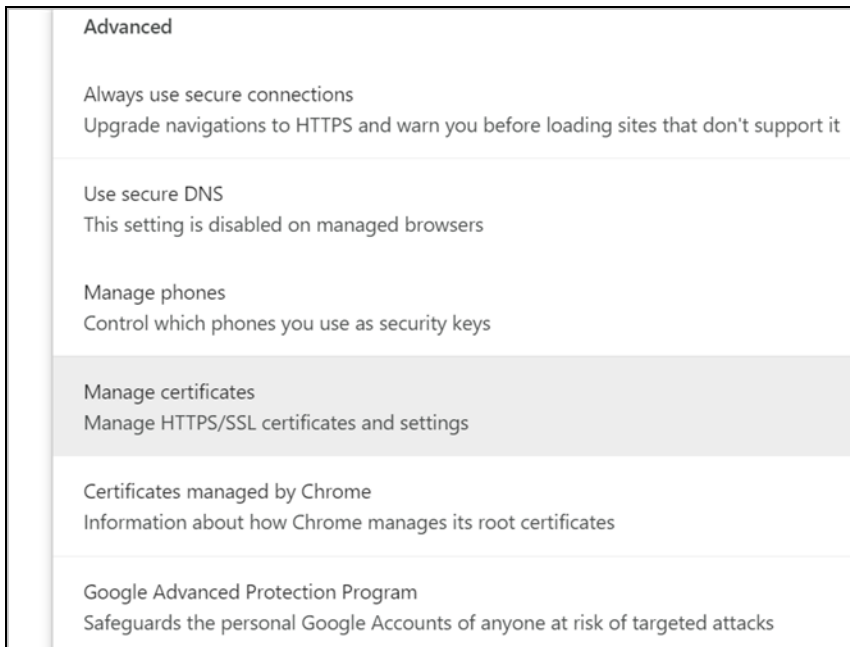

- 3 Select the **Trusted Root Certification Authorities** tab and click **Import**.

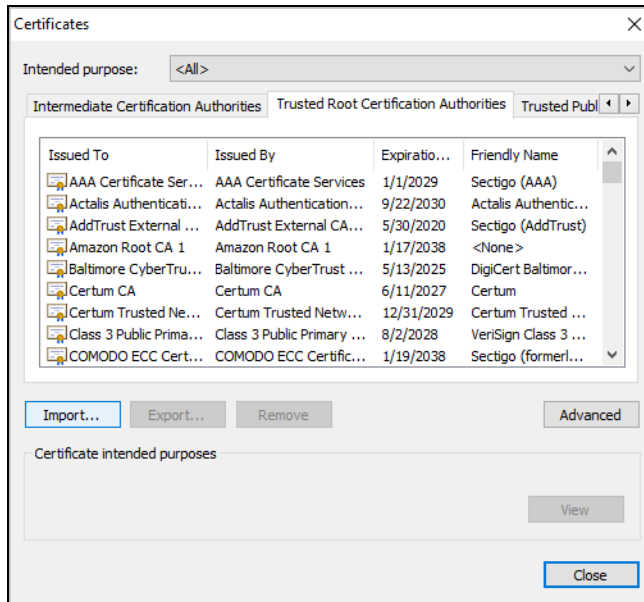

- 4 Click **Next** to proceed to the **Certificate Import Wizard**.

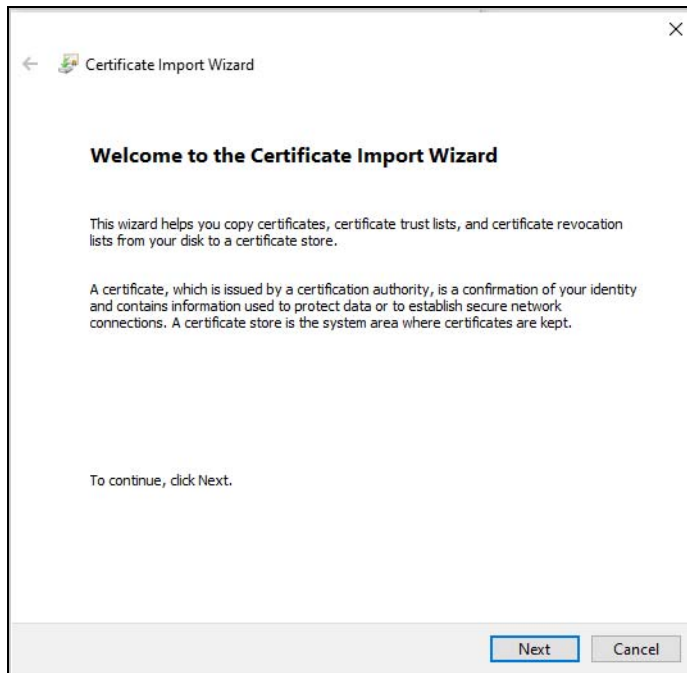

- 5 Click **Browse** to select a certificate already saved in your computer and click **Next** to continue.

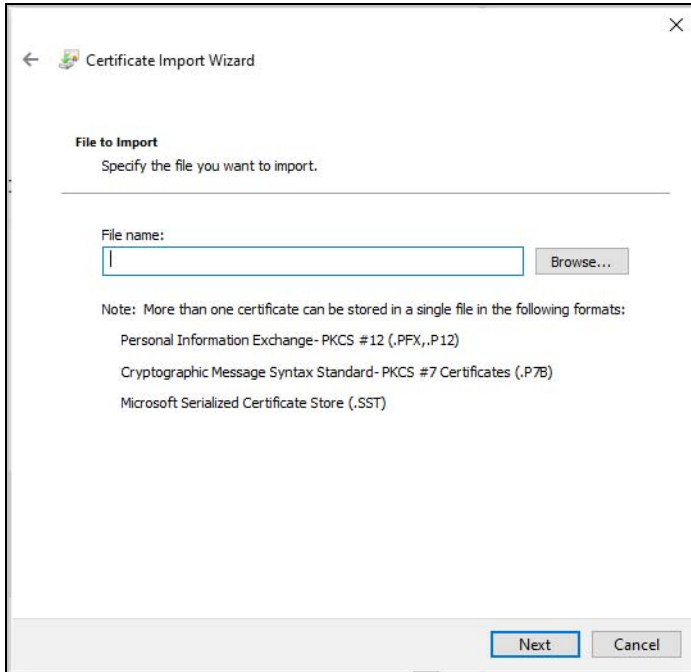

Select **All Files** to find the certificate in your computer.

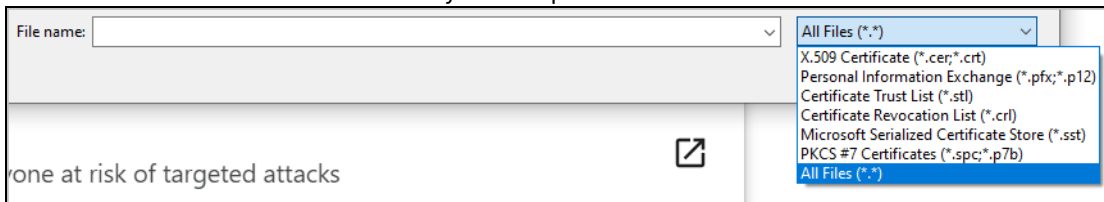

- Two options are available for certificate stores. One is **Automatically select the certificate store based on the type of certificate**. This means the certificate import wizard can identify from the certificate whether it is a CA certificate or a personal certificate, and install it into the appropriate certificate store. The other option is **Place all certificates in the following store**. With this option, you can choose the desired folder for the certificate store. After selection, click **Next**.

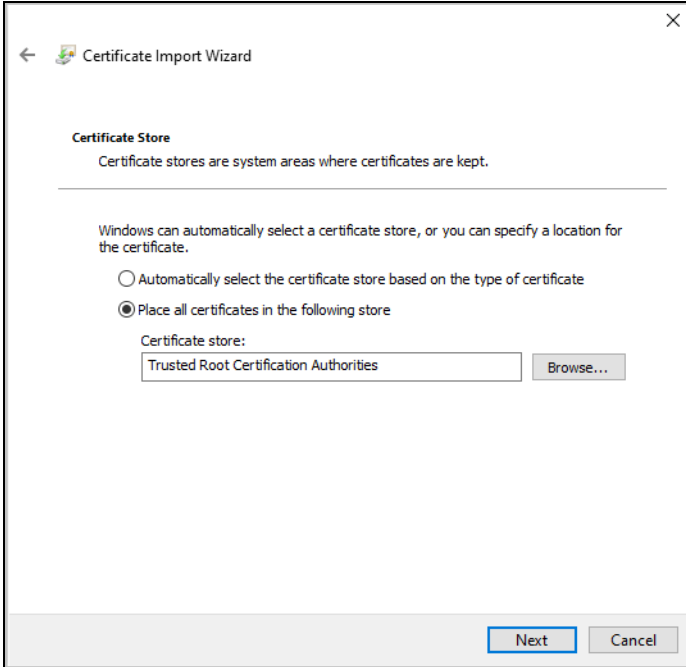

- 7 The security warning message shows up and click **Yes**.

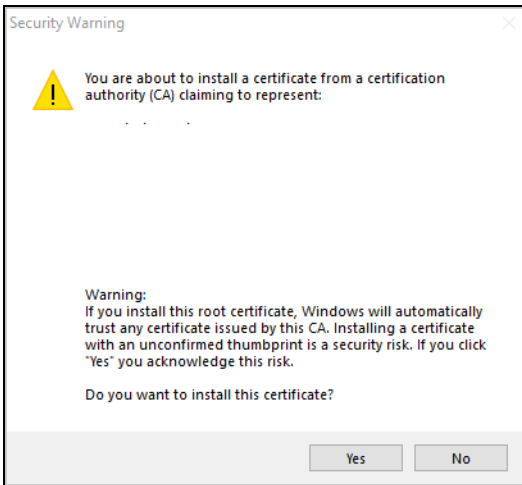

- 8 Click **Finish**.

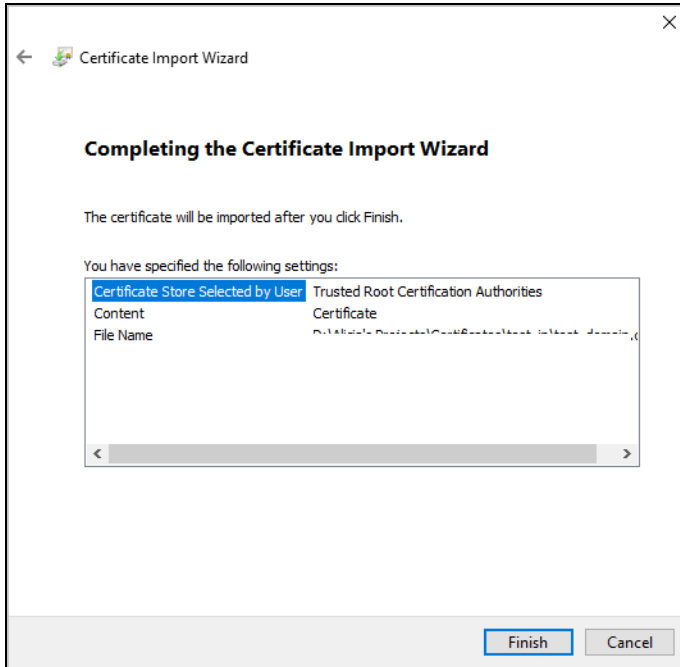

When you click **Finish**, a pop-up screen informs you about import completion.

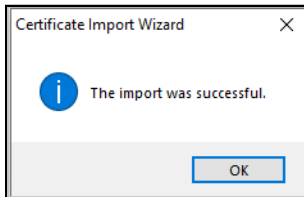

Remove a Certificate in Google Chrome and Microsoft Edge

This section shows you how to remove a public key certificate in Google Chrome and Microsoft Edge on Windows 10 Pro.

- 1 Open your web browser, click the menu icon, and click **Settings**.

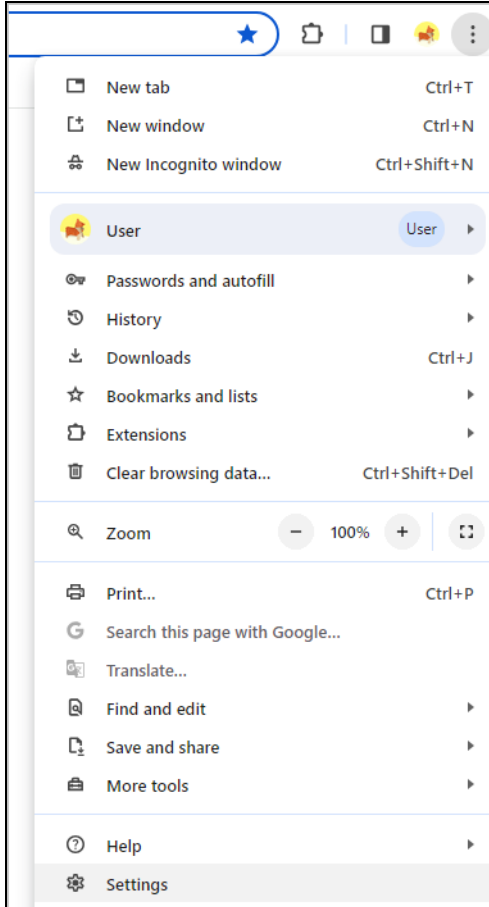

- 2 In Google Chrome, click **Privacy and security > Security > Manage certificates**. In Microsoft Edge, click **Privacy, search, and services > Manage certificates**.

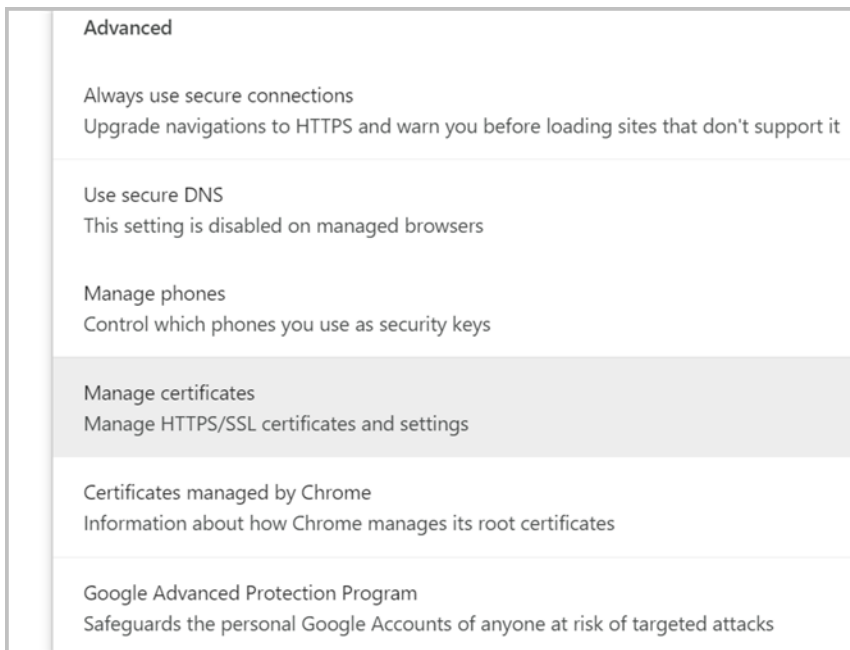

- 3 In the **Certificates** pop-up screen, select the **Trusted Root Certification Authorities** tab.

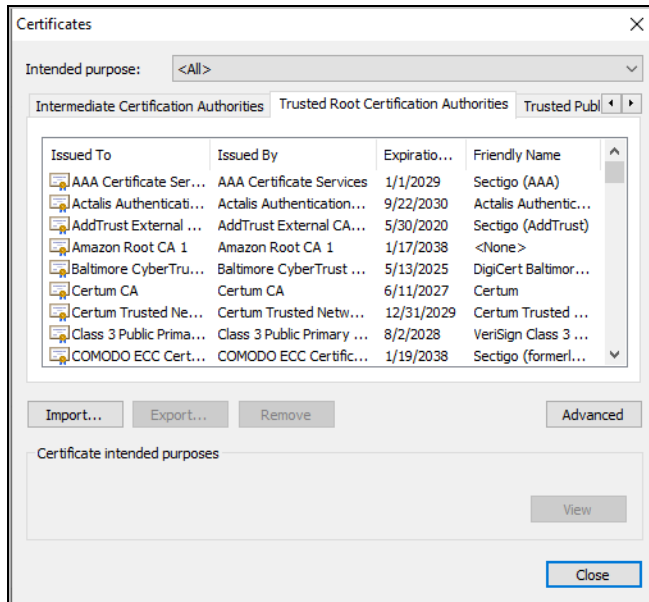

- 4 Select the certificate you want to remove and click **Remove**.
- 5 Click **Yes** when you see the following warning message.

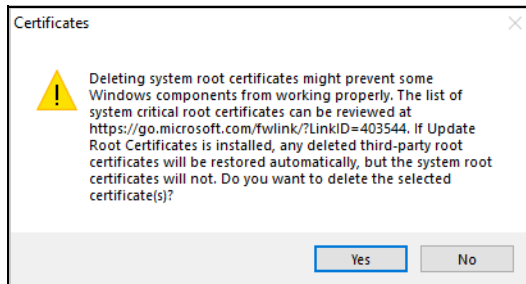

- 6 Confirm the details displayed in the warning message and click **Yes**.

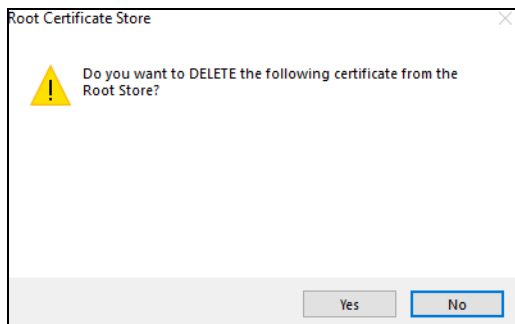

Import a Certificate to Mozilla Firefox

The following example uses Mozilla Firefox on Windows 10 Pro. You first have to store the certificate in your computer and then install it as a Trusted Root CA. To import a certificate to the Firefox browser, please follow the steps below.

- 1 Open Firefox browser and click **Option** bar with three horizontal lines on the upper right corner. Click **Settings**.

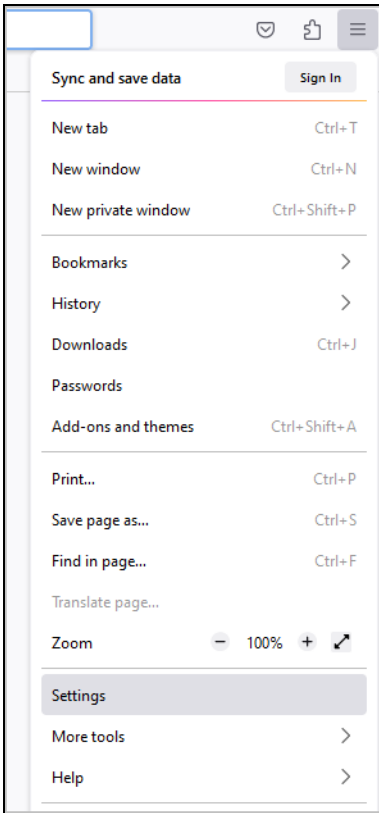

- 2 Click **Privacy & Security**.

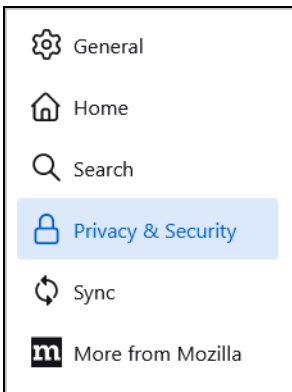

- 3 On the screen of **Privacy & Security**, scroll down to find **Certificates** and click **View Certificates**.

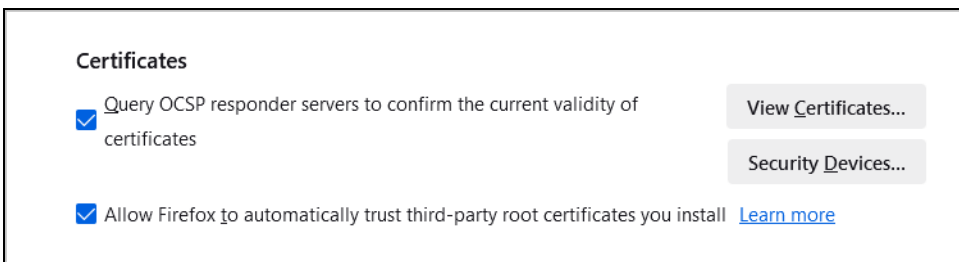

- 4 After the **Certificate Manager** displays, select the **Authorities** tab and click **Import**.

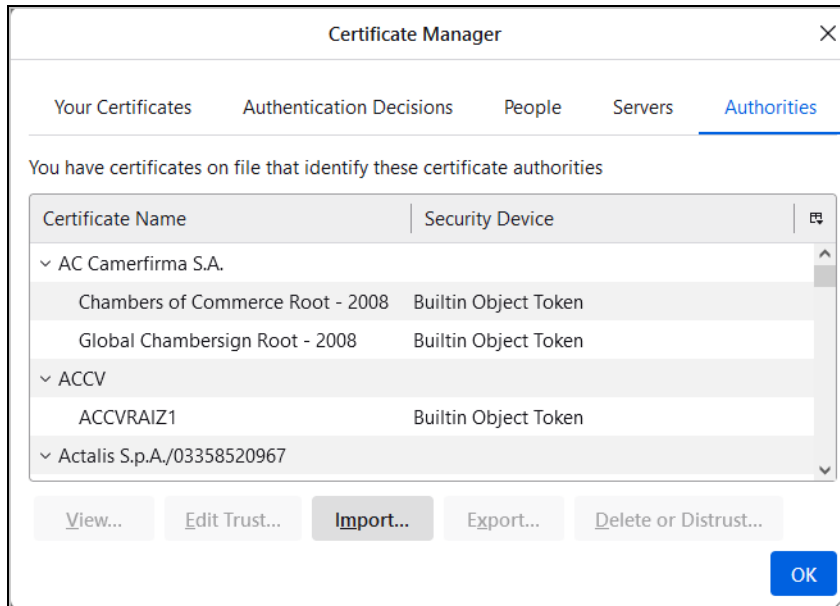

- 5 Open the certificate file in your computer and the **Downloading Certificate** screen shows up. Click **Trust this CA to identify websites**. Click **View** to examine the imported CA certificate.

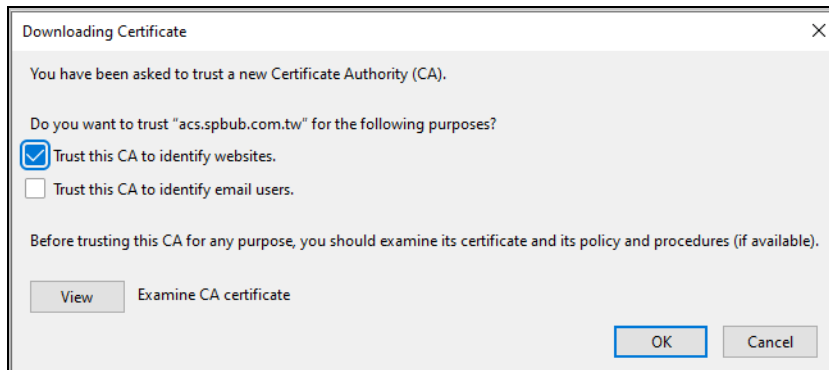

- 6 After clicking **View**, the certificate details appear. Examine the content, ensuring the correct organization name. Verify that the validity period has the accurate start and end dates. The common name can be either an IP or domain name. Confirm that the client's used IP or domain name aligns with the Common Name on the certificate. If all the information on the certificate is correct, close the certificate screen and click **OK**.

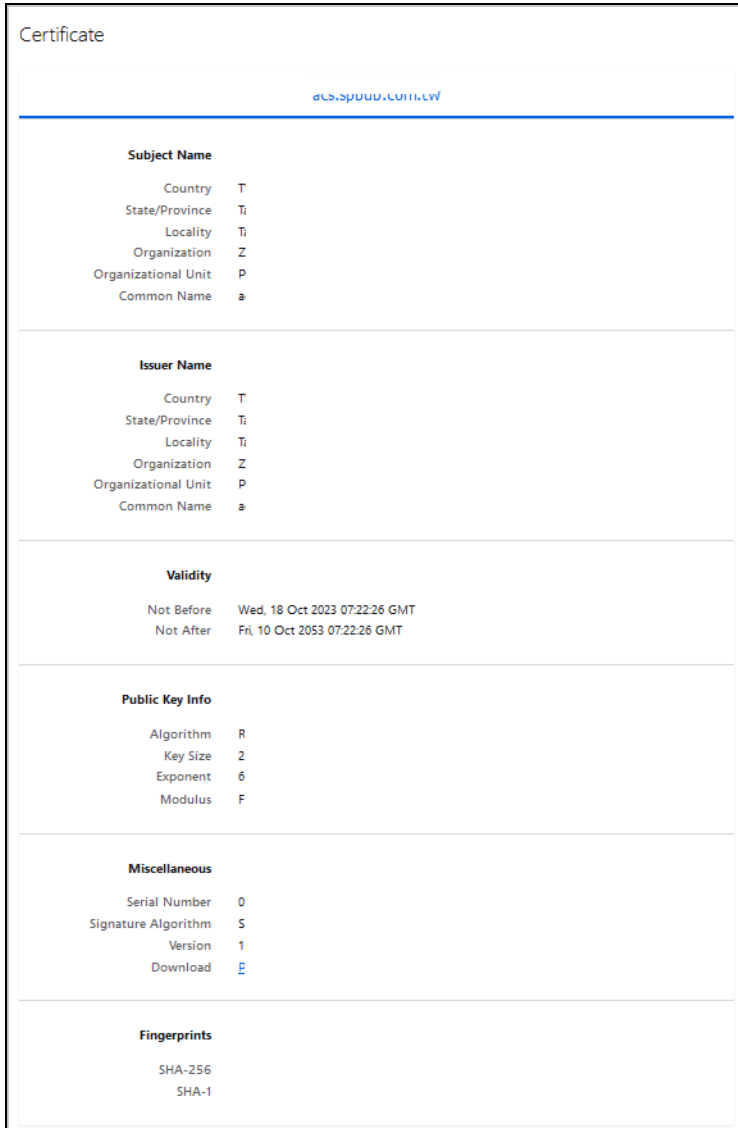

The certificate file is installed in Firefox now.

To check if the import is successful, click **Import** to select the same certificate again to see if the alert **"This certificate is already installed as a certificate authority"** pops out.

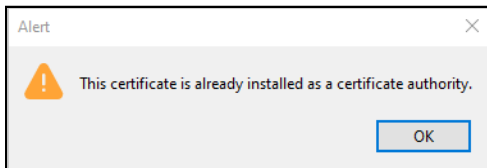

Removing a Certificate in Firefox

This section shows you how to remove a public key certificate in Firefox.

- 1 Open Firefox browser and click **Option** bar with three horizontal lines on the upper right corner. Click **Settings**.

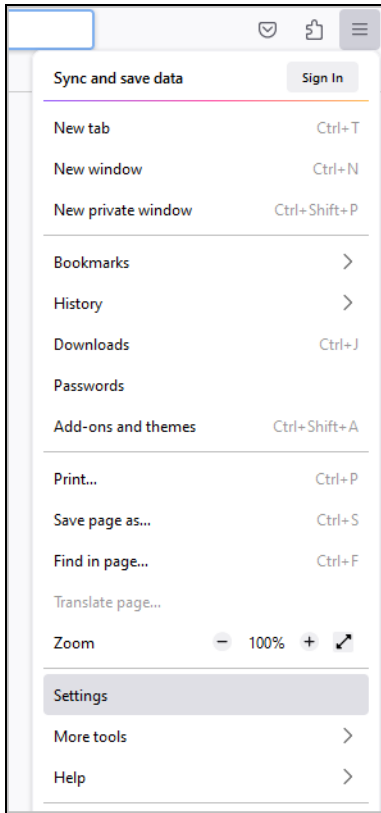

- 2 Click **Privacy & Security**.

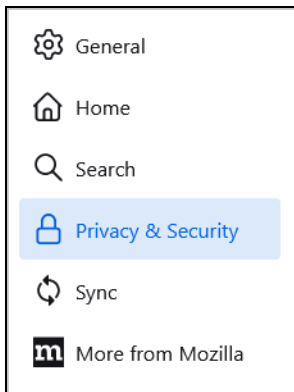

- 3 On the screen of **Privacy & Security**, scroll down to find **Certificates** and click **View Certificates**.

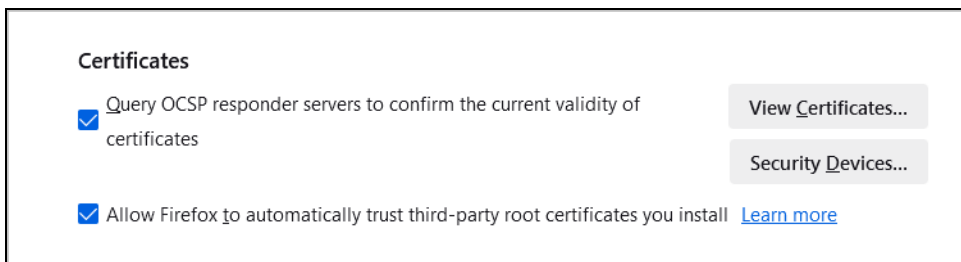

- In the **Certificate Manager**, click **Authorities** and select the certificate you want to remove. Click **Delete or Distrust**.

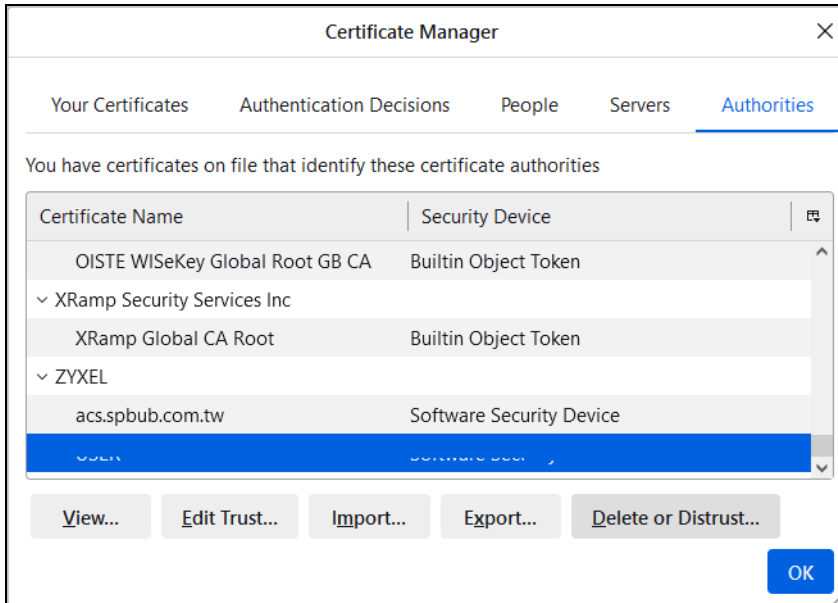

- In the following dialog box, click **OK**.

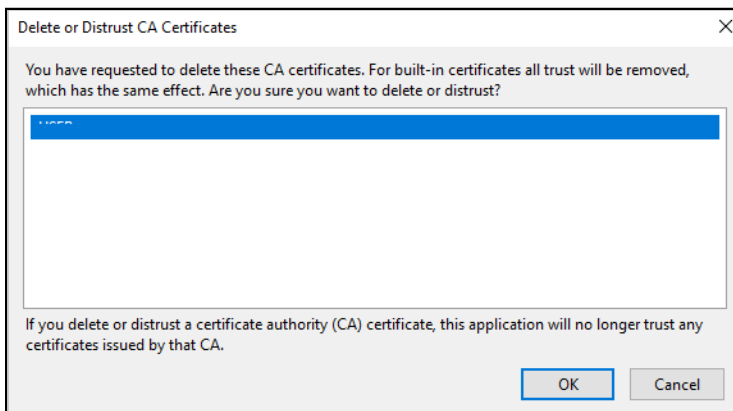

- The next time you go to the web site that issued the public key certificate you just removed, a certification error appears.

APPENDIX C

IPv6

Overview

IPv6 (Internet Protocol version 6), is designed to enhance IP address size and features. The increase in IPv6 address size to 128 bits (from the 32-bit IPv4 address) allows up to 3.4×10^{38} IP addresses.

IPv6 Addressing

The 128-bit IPv6 address is written as eight 16-bit hexadecimal blocks separated by colons (:). This is an example IPv6 address `2001:0db8:1a2b:0015:0000:0000:1a2f:0000`.

IPv6 addresses can be abbreviated in two ways:

- Leading zeros in a block can be omitted. So `2001:0db8:1a2b:0015:0000:0000:1a2f:0000` can be written as `2001:db8:1a2b:15:0:0:1a2f:0`.
- Any number of consecutive blocks of zeros can be replaced by a double colon. A double colon can only appear once in an IPv6 address. So `2001:0db8:0000:0000:1a2f:0000:0000:0015` can be written as `2001:0db8::1a2f:0000:0000:0015`, `2001:0db8:0000:0000:1a2f::0015`, `2001:db8::1a2f:0:0:15` or `2001:db8:0:0:1a2f::15`.

Prefix and Prefix Length

Similar to an IPv4 subnet mask, IPv6 uses an address prefix to represent the network address. An IPv6 prefix length specifies how many most significant bits (start from the left) in the address compose the network address. The prefix length is written as “/x” where x is a number. For example,

`2001:db8:1a2b:15::1a2f:0/32`

means that the first 32 bits (`2001:db8`) is the subnet prefix.

Link-local Address

A link-local address uniquely identifies a device on the local network (the LAN). It is similar to a “private IP address” in IPv4. You can have the same link-local address on multiple interfaces on a device. A link-local unicast address has a predefined prefix of `fe80::/10`. The link-local unicast address format is as follows.

Table 113 Link-local Unicast Address Format

1111 1110 10	0	Interface ID
10 bits	54 bits	64 bits

Global Address

A global address uniquely identifies a device on the Internet. It is similar to a “public IP address” in IPv4. A global unicast address starts with a 2 or 3.

Unspecified Address

An unspecified address (0:0:0:0:0:0:0 or ::) is used as the source address when a device does not have its own address. It is similar to “0.0.0.0” in IPv4.

Loopback Address

A loopback address (0:0:0:0:0:0:0:1 or ::1) allows a host to send packets to itself. It is similar to “127.0.0.1” in IPv4.

Multicast Address

In IPv6, multicast addresses provide the same functionality as IPv4 broadcast addresses. Broadcasting is not supported in IPv6. A multicast address allows a host to send packets to all hosts in a multicast group.

Multicast scope allows you to determine the size of the multicast group. A multicast address has a predefined prefix of ff00::/8. The following table describes some of the predefined multicast addresses.

Table 114 Predefined Multicast Address

MULTICAST ADDRESS	DESCRIPTION
FF01:0:0:0:0:0:0:1	All hosts on a local node.
FF01:0:0:0:0:0:0:2	All routers on a local node.
FF02:0:0:0:0:0:0:1	All hosts on a local connected link.
FF02:0:0:0:0:0:0:2	All routers on a local connected link.
FF05:0:0:0:0:0:0:2	All routers on a local site.
FF05:0:0:0:0:0:1:3	All DHCP servers on a local site.

The following table describes the multicast addresses which are reserved and can not be assigned to a multicast group.

Table 115 Reserved Multicast Address

MULTICAST ADDRESS
FF00:0:0:0:0:0:0:0
FF01:0:0:0:0:0:0:0
FF02:0:0:0:0:0:0:0
FF03:0:0:0:0:0:0:0
FF04:0:0:0:0:0:0:0
FF05:0:0:0:0:0:0:0
FF06:0:0:0:0:0:0:0
FF07:0:0:0:0:0:0:0
FF08:0:0:0:0:0:0:0
FF09:0:0:0:0:0:0:0

Table 115 Reserved Multicast Address (continued)

MULTICAST ADDRESS
FF0A:0:0:0:0:0:0:0
FF0B:0:0:0:0:0:0:0
FF0C:0:0:0:0:0:0:0
FF0D:0:0:0:0:0:0:0
FF0E:0:0:0:0:0:0:0
FF0F:0:0:0:0:0:0:0

Subnet Masking

Both an IPv6 address and IPv6 subnet mask compose of 128-bit binary digits, which are divided into eight 16-bit blocks and written in hexadecimal notation. Hexadecimal uses four bits for each character (1 ~ 10, A ~ F). Each block's 16 bits are then represented by four hexadecimal characters. For example, FFFF:FFFF:FFFF:FFFF:FC00:0000:0000:0000.

Interface ID

In IPv6, an interface ID is a 64-bit identifier. It identifies a physical interface (for example, an Ethernet port) or a virtual interface (for example, the management IP address for a VLAN). One interface should have a unique interface ID.

EUI-64

The EUI-64 (Extended Unique Identifier) defined by the IEEE (Institute of Electrical and Electronics Engineers) is an interface ID format designed to adapt with IPv6. It is derived from the 48-bit (6-byte) Ethernet MAC address as shown next. EUI-64 inserts the hex digits fffe between the third and fourth bytes of the MAC address and complements the seventh bit of the first byte of the MAC address. See the following example.

Table 116

MAC	00	:	13	:	49	:	12	:	34	:	56

Table 117

EUI-64	02	:	13	:	49	:	FF	:	FE	:	12	:	34	:	56

Stateless Autoconfiguration

With stateless autoconfiguration in IPv6, addresses can be uniquely and automatically generated. Unlike DHCPv6 (Dynamic Host Configuration Protocol version six) which is used in IPv6 stateful autoconfiguration, the owner and status of addresses don't need to be maintained by a DHCP server. Every IPv6 device is able to generate its own and unique IP address automatically when IPv6 is initiated on its interface. It combines the prefix and the interface ID (generated from its own Ethernet MAC address, see [Interface ID](#) and [EUI-64](#)) to form a complete IPv6 address.

When IPv6 is enabled on a device, its interface automatically generates a link-local address (beginning with fe80).

When the interface is connected to a network with a router and the Zyxel Device is set to automatically obtain an IPv6 network prefix from the router for the interface, it generates ¹another address which combines its interface ID and global and subnet information advertised from the router. This is a routable global IP address.

DHCPv6

The Dynamic Host Configuration Protocol for IPv6 (DHCPv6, RFC 3315) is a server-client protocol that allows a DHCP server to assign and pass IPv6 network addresses, prefixes and other configuration information to DHCP clients. DHCPv6 servers and clients exchange DHCP messages using UDP.

Each DHCP client and server has a unique DHCP Unique Identifier (DUID), which is used for identification when they are exchanging DHCPv6 messages. The DUID is generated from the MAC address, time, vendor assigned ID and/or the vendor's private enterprise number registered with the IANA. It should not change over time even after you reboot the device.

Identity Association

An Identity Association (IA) is a collection of addresses assigned to a DHCP client, through which the server and client can manage a set of related IP addresses. Each IA must be associated with exactly one interface. The DHCP client uses the IA assigned to an interface to obtain configuration from a DHCP server for that interface. Each IA consists of a unique IAID and associated IP information.

The IA type is the type of address in the IA. Each IA holds one type of address. IA_NA means an identity association for non-temporary addresses and IA_TA is an identity association for temporary addresses. An IA_NA option contains the T1 and T2 fields, but an IA_TA option does not. The DHCPv6 server uses T1 and T2 to control the time at which the client contacts with the server to extend the lifetimes on any addresses in the IA_NA before the lifetimes expire. After T1, the client sends the server (**S1**) (from which the addresses in the IA_NA were obtained) a Renew message. If the time T2 is reached and the server does not respond, the client sends a Rebind message to any available server (**S2**). For an IA_TA, the client may send a Renew or Rebind message at the client's discretion.

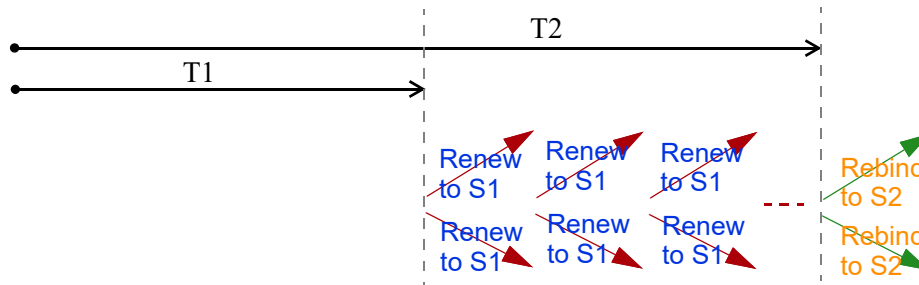

DHCP Relay Agent

A DHCP relay agent is on the same network as the DHCP clients and helps forward messages between the DHCP server and clients. When a client cannot use its link-local address and a well-known multicast address to locate a DHCP server on its network, it then needs a DHCP relay agent to send a message to a DHCP server that is not attached to the same network.

1. In IPv6, all network interfaces can be associated with several addresses.

The DHCP relay agent can add the remote identification (remote-ID) option and the interface-ID option to the Relay-Forward DHCPv6 messages. The remote-ID option carries a user-defined string, such as the system name. The interface-ID option provides slot number, port information and the VLAN ID to the DHCPv6 server. The remote-ID option (if any) is stripped from the Relay-Reply messages before the relay agent sends the packets to the clients. The DHCP server copies the interface-ID option from the Relay-Forward message into the Relay-Reply message and sends it to the relay agent. The interface-ID should not change even after the relay agent restarts.

Prefix Delegation

Prefix delegation enables an IPv6 router to use the IPv6 prefix (network address) received from the ISP (or a connected uplink router) for its LAN. The Zyxel Device uses the received IPv6 prefix (for example, 2001:db2::/48) to generate its LAN IP address. Through sending Router Advertisements (RAs) regularly by multicast, the Zyxel Device passes the IPv6 prefix information to its LAN hosts. The hosts then can use the prefix to generate their IPv6 addresses.

ICMPv6

Internet Control Message Protocol for IPv6 (ICMPv6 or ICMP for IPv6) is defined in RFC 4443. ICMPv6 has a preceding Next Header value of 58, which is different from the value used to identify ICMP for IPv4. ICMPv6 is an integral part of IPv6. IPv6 nodes use ICMPv6 to report errors encountered in packet processing and perform other diagnostic functions, such as "ping".

Neighbor Discovery Protocol (NDP)

The Neighbor Discovery Protocol (NDP) is a protocol used to discover other IPv6 devices and track neighbor's reachability in a network. An IPv6 device uses the following ICMPv6 messages types:

- Neighbor solicitation: A request from a host to determine a neighbor's link-layer address (MAC address) and detect if the neighbor is still reachable. A neighbor being "reachable" means it responds to a neighbor solicitation message (from the host) with a neighbor advertisement message.
- Neighbor advertisement: A response from a node to announce its link-layer address.
- Router solicitation: A request from a host to locate a router that can act as the default router and forward packets.
- Router advertisement: A response to a router solicitation or a periodical multicast advertisement from a router to advertise its presence and other parameters.

IPv6 Cache

An IPv6 host is required to have a neighbor cache, destination cache, prefix list and default router list. The Zyxel Device maintains and updates its IPv6 caches constantly using the information from response messages. In IPv6, the Zyxel Device configures a link-local address automatically, and then sends a neighbor solicitation message to check if the address is unique. If there is an address to be resolved or verified, the Zyxel Device also sends out a neighbor solicitation message. When the Zyxel Device receives a neighbor advertisement in response, it stores the neighbor's link-layer address in the neighbor cache.

When the Zyxel Device uses a router solicitation message to query for a router and receives a router advertisement message, it adds the router's information to the neighbor cache, prefix list and destination cache. The Zyxel Device creates an entry in the default router list cache if the router can be used as a default router.

When the Zyxel Device needs to send a packet, it first consults the destination cache to determine the next hop. If there is no matching entry in the destination cache, the Zyxel Device uses the prefix list to determine whether the destination address is on-link and can be reached directly without passing through a router. If the address is onlink, the address is considered as the next hop. Otherwise, the Zyxel Device determines the next-hop from the default router list or routing table. Once the next hop IP address is known, the Zyxel Device looks into the neighbor cache to get the link-layer address and sends the packet when the neighbor is reachable. If the Zyxel Device cannot find an entry in the neighbor cache or the state for the neighbor is not reachable, it starts the address resolution process. This helps reduce the number of IPv6 solicitation and advertisement messages.

Multicast Listener Discovery

The Multicast Listener Discovery (MLD) protocol (defined in RFC 2710) is derived from IPv4's Internet Group Management Protocol version 2 (IGMPv2). MLD uses ICMPv6 message types, rather than IGMP message types. MLDv1 is equivalent to IGMPv2 and MLDv2 is equivalent to IGMPv3.

MLD allows an IPv6 switch or router to discover the presence of MLD listeners who wish to receive multicast packets and the IP addresses of multicast groups the hosts want to join on its network.

MLD snooping and MLD proxy are analogous to IGMP snooping and IGMP proxy in IPv4.

MLD filtering controls which multicast groups a port can join.

MLD Messages

A multicast router or switch periodically sends general queries to MLD hosts to update the multicast forwarding table. When an MLD host wants to join a multicast group, it sends an MLD Report message for that address.

An MLD Done message is equivalent to an IGMP Leave message. When an MLD host wants to leave a multicast group, it can send a Done message to the router or switch. The router or switch then sends a group-specific query to the port on which the Done message is received to determine if other devices connected to this port should remain in the group.

Example - Enabling IPv6 on Windows XP/2003/Vista

By default, Windows XP and Windows 2003 support IPv6. This example shows you how to use the `ipv6 install` command on Windows XP/2003 to enable IPv6. This also displays how to use the `ipconfig` command to see auto-generated IP addresses.

```
C:\>ipv6 install
Installing...
Succeeded.

C:\>ipconfig

Windows IP Configuration

Ethernet adapter Local Area Connection:

    Connection-specific DNS Suffix  . :
    IP Address. . . . . : 10.1.1.46
    Subnet Mask . . . . . : 255.255.255.0
    IP Address. . . . . : fe80::2d0:59ff:feb8:103c%4
    Default Gateway . . . . . : 10.1.1.254
```

IPv6 is installed and enabled by default in Windows Vista. Use the `ipconfig` command to check your automatic configured IPv6 address as well. You should see at least one IPv6 address available for the interface on your computer.

Example - Enabling DHCPv6 on Windows XP

Windows XP does not support DHCPv6. If your network uses DHCPv6 for IP address assignment, you have to additionally install a DHCPv6 client software on your Windows XP. (Note: If you use static IP addresses or Router Advertisement for IPv6 address assignment in your network, ignore this section.)

This example uses Dibbler as the DHCPv6 client. To enable DHCPv6 client on your computer:

- 1 Install Dibbler and select the DHCPv6 client option on your computer.
- 2 After the installation is complete, select **Start > All Programs > Dibbler-DHCPv6 > Client Install as service.**
- 3 Select **Start > Control Panel > Administrative Tools > Services.**
- 4 Double click **Dibbler - a DHCPv6 client.**

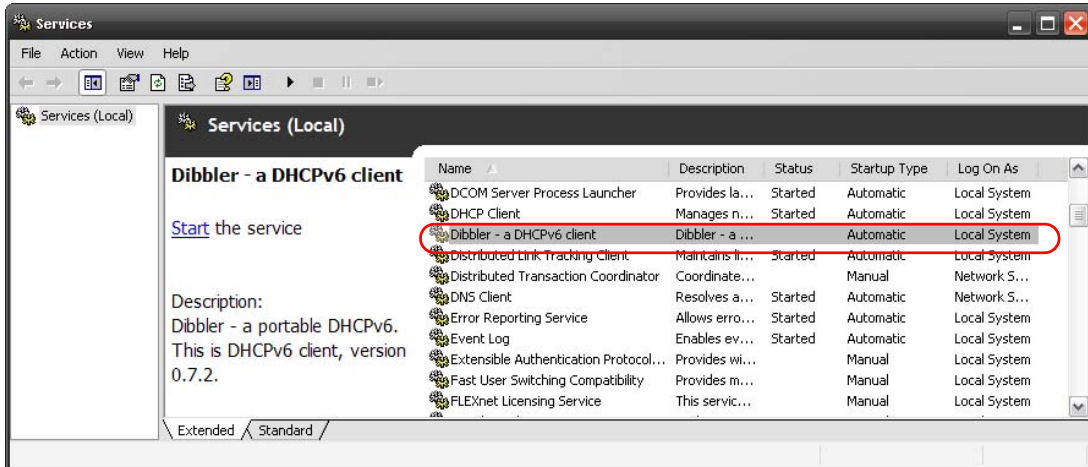

- 5 Click **Start** and then **OK**.

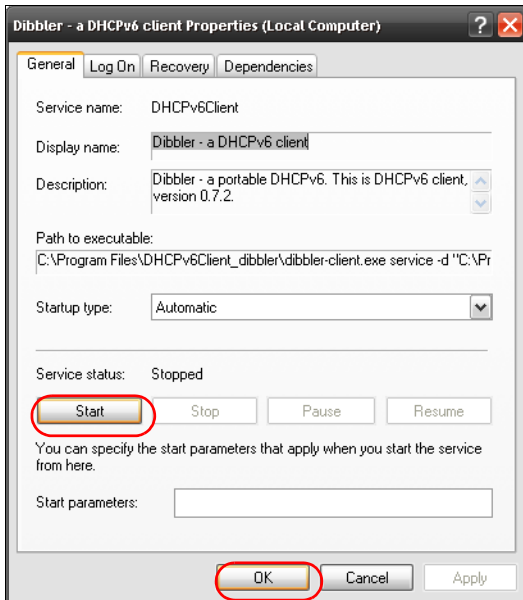

- 6 Now your computer can obtain an IPv6 address from a DHCPv6 server.

Example - Enabling IPv6 on Windows 7

Windows 7 supports IPv6 by default. DHCPv6 is also enabled when you enable IPv6 on a Windows 7 computer.

To enable IPv6 in Windows 7:

- 1 Select **Control Panel > Network and Sharing Center > Local Area Connection**.
- 2 Select the **Internet Protocol Version 6 (TCP/IPv6)** checkbox to enable it.
- 3 Click **OK** to save the change.

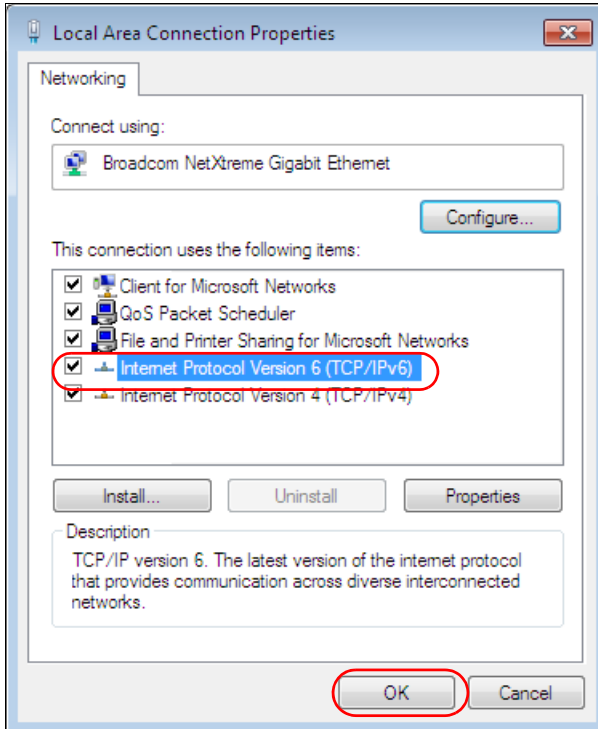

- 4 Click **Close** to exit the **Local Area Connection Status** screen.
- 5 Select **Start > All Programs > Accessories > Command Prompt**.
- 6 Use the `ipconfig` command to check your dynamic IPv6 address. This example shows a global address (2001:b021:2d::1000) obtained from a DHCP server.

```
C:\>ipconfig

Windows IP Configuration

Ethernet adapter Local Area Connection:

    Connection-specific DNS Suffix  . :
    IPv6 Address. . . . . : 2001:b021:2d::1000
    Link-local IPv6 Address . . . . . : fe80::25d8:dcab:c80a:5189%11
    IPv4 Address. . . . . : 172.16.100.61
    Subnet Mask . . . . . : 255.255.255.0
    Default Gateway . . . . . : fe80::213:49ff:feaa:7125%11
                                172.16.100.254
```

APPENDIX D

Customer Support

In the event of problems that cannot be solved by using this manual, you should contact your vendor. If you cannot contact your vendor, then contact a Zyxel office for the region in which you bought the device.

For Zyxel Communication offices, see <https://service-provider.zyxel.com/global/en/contact-us> for the latest information.

For Zyxel Network offices, see <https://www.zyxel.com/index.shtml> for the latest information.

Please have the following information ready when you contact an office.

Required Information

- Product model and serial number.
- Warranty Information.
- Date that you received your device.
- Brief description of the problem and the steps you took to solve it.

Corporate Headquarters (Worldwide)

Taiwan

- Zyxel Communications (Taiwan) Co., Ltd.
- <https://www.zyxel.com>

Asia

China

- Zyxel Communications Corporation–China Office
- <https://www.zyxel.com/cn/sc>

India

- Zyxel Communications Corporation–India Office
- <https://www.zyxel.com/in/en-in>

Kazakhstan

- Zyxel Kazakhstan

- <https://www.zyxel.com/ru/ru>

Korea

- Zyxel Korea Co., Ltd.
- <http://www.zyxel.kr/>

Malaysia

- Zyxel Communications Corp.
- <https://www.zyxel.com/global/en>

Philippines

- Zyxel Communications Corp.
- <https://www.zyxel.com/global/en>

Singapore

- Zyxel Communications Corp.
- <https://www.zyxel.com/global/en>

Taiwan

- Zyxel Communications (Taiwan) Co., Ltd.
- <https://www.zyxel.com/tw/zh>

Thailand

- Zyxel Thailand Co., Ltd.
- <https://www.zyxel.com/th/th>

Vietnam

- Zyxel Communications Corporation–Vietnam Office
- <https://www.zyxel.com/vn/vi>

Europe

Belarus

- Zyxel Communications Corp.
- <https://www.zyxel.com/ru/ru>

Belgium (Netherlands)

- Zyxel Benelux
- <https://www.zyxel.com/nl/nl>
- <https://www.zyxel.com/fr/fr>

Bulgaria

- Zyxel Bulgaria
- <https://www.zyxel.com/bg/bg>

Czech Republic

- Zyxel Communications Czech s.r.o.
- <https://www.zyxel.com/cz/cs>

Denmark

- Zyxel Communications A/S
- <https://www.zyxel.com/dk/da>

Finland

- Zyxel Communications
- <https://www.zyxel.com/fi/fi>

France

- Zyxel France
- <https://www.zyxel.com/fr/fr>

Germany

- Zyxel Deutschland GmbH.
- <https://www.zyxel.com/de/de>

Hungary

- Zyxel Hungary & SEE
- <https://www.zyxel.com/hu/hu>

Italy

- Zyxel Communications Italy S.r.l.
- <https://www.zyxel.com/it/it>

Norway

- Zyxel Communications A/S
- <https://www.zyxel.com/no/no>

Poland

- Zyxel Communications Poland
- <https://www.zyxel.com/pl/pl>

Romania

- Zyxel Romania

- <https://www.zyxel.com/ro/ro>

Russian Federation

- Zyxel Communications Corp.
- <https://www.zyxel.com/ru/ru>

Slovakia

- Zyxel Slovakia
- <https://www.zyxel.com/sk/sk>

Spain

- Zyxel Iberia
- <https://www.zyxel.com/es/es>

Sweden

- Zyxel Communications A/S
- <https://www.zyxel.com/se/sv>

Switzerland

- Studerus AG
- <https://www.zyxel.com/ch/de-ch>
- <https://www.zyxel.com/fr/fr>

Turkey

- Zyxel Turkey A.S.
- <https://www.zyxel.com/tr/tr>

UK

- Zyxel Communications UK Ltd.
- <https://www.zyxel.com/uk/en-gb>

Ukraine

- Zyxel Ukraine
- <https://www.zyxel.com/ua/uk-ua>

South America

Argentina

- Zyxel Communications Corp.
- <https://www.zyxel.com/co/es-co>

Brazil

- Zyxel Communications Brasil Ltda.
- <https://www.zyxel.com/br/pt>

Colombia

- Zyxel Communications Corp.
- <https://www.zyxel.com/co/es-co>

Ecuador

- Zyxel Communications Corp.
- <https://www.zyxel.com/co/es-co>

South America

- Zyxel Communications Corp.
- <https://www.zyxel.com/co/es-co>

Middle East

Israel

- Zyxel Communications Corp.
- <https://il.zyxel.com>

North America

USA

- Zyxel Communications, Inc. – North America Headquarters
- <https://www.zyxel.com/us/en-us>

APPENDIX E

Legal Information

Copyright

Copyright © 2026 by Zyxel and/or its affiliates

The contents of this publication may not be reproduced in any part or as a whole, transcribed, stored in a retrieval system, translated into any language, or transmitted in any form or by any means, electronic, mechanical, magnetic, optical, chemical, photocopying, manual, or otherwise, without the prior written permission of Zyxel and/or its affiliates.

Published by Zyxel and/or its affiliates. All rights reserved.

Disclaimers

Zyxel does not assume any liability arising out of the application or use of any products, or software described herein. Neither does it convey any license under its patent rights nor the patent rights of others. Zyxel further reserves the right to make changes in any products described herein without notice. This publication is subject to change without notice.

Your use of the Zyxel Device is subject to the terms and conditions of any related service providers.

Trademarks

Trademarks mentioned in this publication are used for identification purposes only and may be properties of their respective owners.

Regulatory Notice and Statement (Class B)

Model List: NWA50AX, NWA30BE, NWA50BE, NWA90AX, NWA90BE, NWA55AXE, NWA55AX PRO, NWA55BE, NWA50AX PRO, NWA50BE PRO, NWA90AX PRO, NWA90BE PRO

United States of America



The following information applies if you use the product within USA area.

Federal Communications Commission (FCC) EMC Statement

- This device complies with part 15 of the FCC Rules. Operation is subject to the following two conditions:
 - (1) This device may not cause harmful interference, and
 - (2) this device must accept any interference received, including interference that may cause undesired operation.
- Changes or modifications not expressly approved by the party responsible for compliance could void the user's authority to operate the device.
- This equipment has been tested and found to comply with the limits for a Class B digital device, pursuant to Part 15 of the FCC Rules. These limits are designed to provide reasonable protection against harmful interference in a residential installation. This device generates, uses, and can radiate radio frequency energy and, if not installed and used in accordance with the instructions, may cause harmful interference to radio communications. However, there is no guarantee that interference will not occur in a particular installation.
- If this equipment does cause harmful interference to radio or television reception, which can be determined by turning the equipment off and on, the user is encouraged to try to correct the interference by one or more of the following measures:
 - Reorient or relocate the receiving antenna
 - Increase the separation between the equipment and receiver
 - Connect the equipment into an outlet on a circuit different from that to which the receiver is connected
 - Consult the dealer or an experienced radio/TV technician for assistance
 - FCC Caution: Any changes or modifications not expressly approved by the party responsible for compliance could void the user's authority to operate this equipment.

FCC Radiation Exposure Statement

- This device complies with FCC Radio Frequency (RF) radiation exposure limits set forth for an uncontrolled environment.
- This transmitter must be at least 20 cm from the user and must not be co-located or operating in conjunction with any other antenna or transmitter. Refer to the list below for the models whose transmitters require a minimum distance of over 20 cm from the user, along with the required distances.
 - NWA50AX/NWA90AX (Indoor model): 21cm
 - NWA55AXE (Outdoor model): 21cm
- Operation of this device is restricted to indoor use only, except for relevant user's manual mention that this device can be installed into the external environment. (For indoor devices only)
- Country Code selection feature to be disabled for products marketed to the US/CANADA.

Caution (For device with 6 GHz function)

- FCC regulations restrict the operation of this device to indoor use only. (For indoor devices only)
- The operation of this device is prohibited on oil platforms, cars, trains, boats, and aircraft, except that operation of this device is permitted in large aircraft while flying above 10,000 feet.
- Operation of transmitters in the 5.925 - 7.125 GHz band is prohibited for control of or communications with unmanned aircraft systems.

Canada

The following information applies if you use the product within Canada area.

Innovation, Science and Economic Development Canada ICES statement

CAN ICES(B)/NMB(B)

Innovation, Science and Economic Development Canada RSS-GEN & RSS-247 statement

The following information applies to products with wireless functions.

- For indoor use only. (For indoor devices only)
- This device contains licence-exempt transmitter(s)/receiver(s) that comply with Innovation, Science and Economic Development Canada's licence-exempt RSS(s). Operation is subject to the following two conditions: (1) This device may not cause interference; and (2) This device must accept any interference, including interference that may cause undesired operation of the device.
- This radio transmitter (NWA55AXE, 2468C-11AXAP22AO; NWA55BE, 25830-04295) has been approved by Innovation, Science and Economic Development Canada to operate with the antenna types listed below, with the maximum permissible gain indicated. Antenna types not included in this list that have a gain greater than the maximum gain indicated for any type listed are strictly prohibited for use with this device.

Antenna Information

MODEL NAME	NO.	TYPE	GAIN (DBI)	IMPEDANCE
NWA55AXE	1	Dipole	3.74 dBi (2.4 GHz) 4.24 dBi (5 GHz Band 2) 4.24 dBi (5 GHz Band 3) 4.58 dBi (5 GHz Band 4)	50 Ω
	2	Dipole	3.74 dBi (2.4 GHz) 4.24 dBi (5 GHz Band 2) 4.24 dBi (5 GHz Band 3) 4.58 dBi (5 GHz Band 4)	50 Ω
NWA30BE, NWA55BE	1	Dipole	2.8 dBi (2.4 GHz) 4.2 dBi (5 GHz)	50 Ω
	2	Dipole	2.07 dBi (2.4 GHz) 2.93 dBi (5 GHz)	50 Ω

If the product with 5G wireless function operating in 5150-5250 MHz and 5725-5850 MHz, the following attention must be paid,

- The device for operation in the band 5150-5250 MHz is only for indoor use to reduce the potential for harmful interference to co-channel mobile satellite systems.
- For devices with detachable antenna(s), the maximum antenna gain permitted for devices in the band 5725-5850 MHz shall be such that the equipment still complies with the e.i.r.p. limits as appropriate; and
- Where applicable, antenna type(s), antenna models(s), and the worst-case tilt angle(s) necessary to remain compliant with the e.i.r.p. elevation mask requirement set forth in Section 6.2.2.3 of RSS 247 shall be clearly indicated.

If the produce with 5G wireless function operating in 5250-5350 MHz and 5470-5725 MHz, the following attention must be paid.

- For devices with detachable antenna(s), the maximum antenna gain permitted for devices in the bands 5250-5350 MHz and 5470-5725 MHz shall be such that the equipment still complies with the e.i.r.p. limit

Innovation, Sciences et Développement économique Canada RSS-GEN & RSS-247

- Pour une utilisation en intérieur uniquement. (sauf modèle extérieur)
- L'émetteur/récepteur exempt de licence contenu dans le présent appareil est conforme aux CNR d'Innovation, Sciences et Développement économique Canada applicables aux appareils radio exempts de licence. L'exploitation est autorisée aux deux conditions suivantes : (1) l'appareil ne doit pas produire de brouillage; (2) L'appareil doit accepter tout brouillage radioélectrique subi, même si le brouillage est susceptible d'en compromettre le fonctionnement.
- Le présent émetteur radio (NWA55AXE, 2468C-11AXAP22AO; NWA55BE, 25830-04295) a été approuvé par Innovation, Sciences et Développement économique Canada pour fonctionner avec les types d'antenne énumérés ci dessous et ayant un gain admissible maximal. Les types d'antenne non inclus dans cette liste, et dont le gain est supérieur au gain maximal indiqué pour tout type figurant sur la liste, sont strictement interdits pour l'exploitation de l'émetteur.

informations antenne

NOM DU MODÈLE	NB.	TYPE	GAIN (DBI)	IMPÉDANCE
NWA55AXE	1	Dipole	3.74 dBi (2.4 GHz)	50 Ω
			4.24 dBi (5 GHz Band 2)	
			4.24 dBi (5 GHz Band 3)	
			4.58 dBi (5 GHz Band 4)	
	2	Dipole	3.74 dBi (2.4 GHz)	50 Ω
			4.24 dBi (5 GHz Band 2)	
			4.24 dBi (5 GHz Band 3)	
			4.58 dBi (5 GHz Band 4)	
NWA30BE, NWA55BE	1	Dipole	2.8 dBi (2.4 GHz)	50 Ω
			4.2 dBi (5 GHz)	
	2	Dipole	2.07 dBi (2.4 GHz)	50 Ω
			2.93 dBi (5 GHz)	

Lorsque la fonction sans fil 5G fonctionnant en 5150-5250 MHz et 5725-5850 MHz est activée pour ce produit , il est nécessaire de porter une attention particulière aux choses suivantes

- Les dispositifs fonctionnant dans la bande de 5 150 à 5 250 MHz sont réservés uniquement pour une utilisation à l'intérieur afin de réduire les risques de brouillage préjudiciable aux systèmes de satellites mobiles utilisant les mêmes canaux;
- Pour les dispositifs munis d'antennes amovibles, le gain maximal d'antenne permis (pour les dispositifs utilisant la bande de 5 725 à 5 850 MHz) doit être conforme à la limite de la p.i.r.e. spécifiée, selon le cas;

- Lorsqu'il y a lieu, les types d'antennes (s'il y en a plusieurs), les numéros de modèle de l'antenne et les pires angles d'inclinaison nécessaires pour rester conforme à l'exigence de la p.i.r.e. applicable au masque d'élévation, énoncée à la section 6.2.2.3 du CNR-247, doivent être clairement indiqués.

Lorsque la fonction sans fil 5G fonctionnant en 5250-5350 MHz et 5470-5725 MHz est activée pour ce produit, il est nécessaire de porter une attention particulière aux choses suivantes

- Pour les dispositifs munis d'antennes amovibles, le gain maximal d'antenne permis pour les dispositifs utilisant les bandes de 5 250 à 5 350 MHz et de 5 470 à 5 725 MHz doit être conforme à la limite de la p.i.r.e.

Industry Canada radiation exposure statement

This equipment complies with ISED radiation exposure limits set forth for an uncontrolled environment. This equipment should be installed and operated with a minimum distance of 20 cm between the radiator and your body. Refer to the list below for the models whose radiators require a minimum distance of over 20 cm from your body, along with the required distances.

- NWA50AX/NWA90AX: 24 cm
- NWA55AXE: 24 cm

Déclaration d'exposition aux radiations

Cet équipement est conforme aux limites d'exposition aux rayonnements ISED établies pour un environnement non contrôlé. Cet équipement doit être installé et utilisé avec un minimum de 20 cm de distance entre la source de rayonnement et votre corps. Veuillez vous référer à la liste ci-dessous pour connaître les modèles dont les radiateurs nécessitent une distance minimale de plus de 20 cm par rapport à votre corps, ainsi que les distances requises.

- NWA50AX/NWA90AX: 24 cm
- NWA55AXE: 24 cm

Caution:

- the device for operation in the band 5150 5250 MHz is only for indoor use to reduce the potential for harmful interference to co channel mobile satellite systems;
- the maximum antenna gain permitted for devices in the bands 5250 5350 MHz and 5470 5725 MHz shall comply with the e.i.r.p. limit; and
- the maximum antenna gain permitted for devices in the band 5725 5825 MHz shall comply with the e.i.r.p. limits specified for point to point and non point to point operation as appropriate.
- Outdoor device: NWA55AXE, NWA55BE, NWA55AX PRO

Caution (For device with 6 GHz function):

- Operation shall be limited to indoor use only (For indoor devices only); and
- Operation on oil platforms, cars, trains, boats and aircraft shall be prohibited except for on large aircraft flying above 10,000 ft.
- Devices shall not be used for control of or communications with unmanned aircraft systems.

Avertissement:

- les dispositifs fonctionnant dans la bande 5150 5250 MHz sont réservés uniquement pour une utilisation à l'intérieur afin de réduire les risques de brouillage préjudiciable aux systèmes de satellites mobiles utilisant les mêmes canaux;
- le gain maximal d'antenne permis pour les dispositifs utilisant les bandes 5250 5350 MHz et 5 470 5 725 MHz doit se conformer à la limite de p.i.r.e.;
- le gain maximal d'antenne permis (pour les dispositifs utilisant la bande 5725 5825 MHz) doit se conformer à la limite de p.i.r.e. spécifiée pour l'exploitation point à point et non point à point, selon le cas.
- Appareil extérieur: NWA55AXE, NWA55BE, NWA55AX PRO

Avertissement (Pour modèle avec fonction 6 GHz)

- Utilisation limitée à l'intérieur seulement (sauf modèle extérieur).
- Utilisation interdite à bord de plateformes de forage pétrolier, de voitures, de trains, de bateaux et d'aéronefs, sauf à bord d'un gros aéronef volant à plus de 10 000 pieds d'altitude.
- Les dispositifs ne doivent pas être utilisés pour commander des systèmes d'aéronef sans pilote ni pour communiquer avec de tels systèmes.

Brazil

The following applies if you use the product within Brazil.

For WiFi 6 products,

- Este equipamento não tem direito à proteção contra interferência prejudicial e não pode causar interferência em sistemas devidamente autorizados.
- Este produto não é apropriado para uso em ambientes domésticos, pois poderá causar interferências eletromagnéticas que obrigam o usuário a tomar medidas necessárias para minimizar estas interferências.

For WiFi 6E and WiFi 7 products,

- Este equipamento não tem direito à proteção contra interferência prejudicial e não pode causar interferência em sistemas devidamente autorizados.
- Este produto não é apropriado para uso em ambientes domésticos, pois poderá causar interferências eletromagnéticas que obrigam o usuário a tomar medidas necessárias para minimizar estas interferências.
- O uso deste equipamento é restrito a ambientes fechados é proibido em plataformas petrolíferas, carros, trens, embarcações e no interior de aeronaves abaixo de 3.048 m (10.000 pés).
- Para maiores informações, consulte o site da Anatel:
www.gov.br/pt-br/search?origem=form&SearchableText=anatel

Europe and the United Kingdom



The following information applies if you use the product within the European Union and United Kingdom.

Declaration of Conformity with Regard to EU Directive 2014/53/EU (Radio Equipment Directive, RED) and UK Radio Equipment Regulations 2017

- Compliance information for wireless products relevant to the EU, United Kingdom and other Countries following the EU Directive 2014/53/EU (RED) and UK regulation 2017 SI 2017-1206. And this product may be used in all EU countries (and other countries following the EU Directive 2014/53/EU) and United Kingdom without any limitation except for the countries mentioned below table:
- In the majority of the EU and other European countries, the 5GHz bands have been made available for the use of wireless local area networks (LANs). Later in this document you will find an overview of countries in which additional restrictions or requirements or both are applicable. The requirements for any country may evolve. Zyxel recommends that you check with the local authorities for the latest status of their national regulations for the 5GHz wireless LANs.
- If this device operates in the 5150-5350 MHz band, it is for indoor use only.
- This equipment should be installed and operated with a minimum distance of 20 cm between the radio equipment and your body.
- The maximum RF operating power for each band is as follows:

FREQUENCY	MAXIMUM POWER
2,400 MHz to 2,483.5 MHz	< 100 mW
5,150 MHz to 5,350 MHz	< 200 mW
5,470 MHz to 5,725 MHz	< 1000 mW
5,945 MHz to 6,425 MHz	< 200 mW
(For device with 6 GHz function)	

	National Restrictions
Belgium (English)	<ul style="list-style-type: none"> • The Belgian Institute for Postal Services and Telecommunications (BIPT) must be notified of any outdoor wireless link having a range exceeding 300 meters. Please check http://www.bipt.be for more details. • Draadloze verbindingen voor buitengebruik en met een reikwijdte van meer dan 300 meter dienen aangemeld te worden bij het Belgisch Instituut voor postdiensten en telecommunicatie (BIPT). Zie http://www.bipt.be voor meer gegevens. • Les liaisons sans fil pour une utilisation en extérieur d'une distance supérieure à 300 mètres doivent être notifiées à l'Institut Belge des services Postaux et des Télécommunications (IBPT). Visitez http://www.ibpt.be pour de plus amples détails.
België (Flemish)	
Belgique (French)	
Čeština (Czech)	Zyxel tímto prohlašuje, že tento zařizení je ve shodě se základními požadavky a dalšími příslušnými ustanoveními směrnice 2014/53/EU.

Dansk (Danish)	Undertegnede Zyxel erklærer herved, at følgende udstyr overholder de væsentlige krav og øvrige relevante krav i direktiv 2014/53/EU.
Deutsch (German)	Hiermit erkläre Zyxel, dass sich das Gerät Ausstattung in Übereinstimmung mit den grundlegenden Anforderungen und den übrigen einschlägigen Bestimmungen der Richtlinie 2014/53/EU befindet.
Eesti keel (Estonian)	Käesolevaga kinnitab Zyxel seadme seadmed vastavust direktiivi 2014/53/EU põhinõuetele ja nimetatud direktiivist tulenevatele teistele asjakohastele sätetele.
Ελληνικά (Greek)	ΜΕ ΤΗΝ ΠΑΡΟΥΣΑ Zyxel ΔΗΛΩΝΕΙ ΟΤΙ ΕΞΟΠΛΙΣΜΟΣ ΣΥΜΜΟΡΦΩΝΕΤΑΙ ΠΡΟΣ ΤΙΣ ΟΥΣΙΩΔΕΙΣ ΑΠΑΙΤΗΣΕΙΣ ΚΑΙ ΤΙΣ ΛΟΙΠΕΣ ΣΧΕΤΙΚΕΣ ΔΙΑΤΑΞΕΙΣ ΤΗΣ ΟΔΗΓΙΑΣ 2014/53/EU.
English	Hereby, Zyxel declares that this device is in compliance with the essential requirements and other relevant provisions of Directive 2014/53/EU.
Español (Spanish)	Por medio de la presente Zyxel declara que el equipo cumple con los requisitos esenciales y cualesquiera otras disposiciones aplicables o exigibles de la Directiva 2014/53/UE.
Français (French)	Par la présente Zyxel déclare que l'appareil équipements est conforme aux exigences essentielles et aux autres dispositions pertinentes de la directive 2014/53/EU.
Hrvatski (Croatian)	Zyxel ovime izjavljuje da je radijska oprema tipa u skladu s Direktivom 2014/53/EU.
Íslenska (Icelandic)	Hér með lýsir, Zyxel því yfir að þessi búnaður er í samræmi við grunnkröfur og önnur viðeigandi ákvæði tilskipunar 2014/53/EU.
Italiano (Italian)	Con la presente Zyxel dichiara che questo attrezzatura è conforme ai requisiti essenziali ed alle altre disposizioni pertinenti stabilite dalla direttiva 2014/53/EU. National Restrictions <ul style="list-style-type: none"> • This product meets the National Radio Interface and the requirements specified in the National Frequency Allocation Table for Italy. Unless this wireless LAN product is operating within the boundaries of the owner's property, its use requires a "general authorization." Please check https://www.mise.gov.it/ for more details. • Questo prodotto è conforme alla specifiche di Interfaccia Radio Nazionali e rispetta il Piano Nazionale di ripartizione delle frequenze in Italia. Se non viene installato all'interno del proprio fondo, l'utilizzo di prodotti Wireless LAN richiede una "Autorizzazione Generale". Consultare https://www.mise.gov.it/ per maggiori dettagli.
Latviešu valoda (Latvian)	Ar šo Zyxel deklarē, ka iekārtas atbilst Direktīvas 2014/53/EU būtiskajām prasībām un citiem ar to saistītajiem noteikumiem.
Lietuvių kalba (Lithuanian)	Šiuo Zyxel deklaruoja, kad šis įranga atitinka esminius reikalavimus ir kitas 2014/53/EU Direktyvos nuostatas.
Magyar (Hungarian)	Alulírott, Zyxel nyilatkozom, hogy a berendezés megfelel a vonatkozó alapvető követelményeknek és az 2014/53/EU irányelv egyéb előírásainak.
Malti (Maltese)	Hawnhekk, Zyxel, jiddikjara li dan tagħmir jikkonforma mal-ħtiġijiet essenzjali u ma provvedimenti oħrajn rilevanti li hemm fid-Direttiva 2014/53/EU.
Nederlands (Dutch)	Hierbij verklaart Zyxel dat het toestel uitrusting in overeenstemming is met de essentiële eisen en de andere relevante bepalingen van richtlijn 2014/53/EU.
Norsk (Norwegian)	Erklærer herved Zyxel at dette utstyret er i samsvar med de grunnleggende kravene og andre relevante bestemmelser i direktiv 2014/53/EU.
Polski (Polish)	Niniejszym Zyxel oświadcza, że sprzęt jest zgodny z zasadniczymi wymogami oraz pozostałymi stosownymi postanowieniami Dyrektywy 2014/53/EU.
Português (Portuguese)	Zyxel declara que este equipamento está conforme com os requisitos essenciais e outras disposições da Directiva 2014/53/EU.
Română (Romanian)	Prin prezenta, Zyxel declară că acest echipament este în conformitate cu cerințele esențiale și alte prevederi relevante ale Directivei 2014/53/EU.
Slovenčina (Slovak)	Zyxel týmto vyhlasuje, že zariadenia spĺňa základné požiadavky a všetky príslušné ustanovenia Smernice 2014/53/EU.
Slovenščina (Slovene)	Zyxel izjavlja, da je ta oprema v skladu z bistvenimi zahtevami in ostalimi relevantnimi določili direktive 2014/53/EU.

Suomi (Finnish)	Zyxel vakuuttaa täten että laitteet tyyppinen laite on direktiivin 2014/53/EU oleellisten vaatimusten ja sitä koskevien direktiivin muiden ehtojen mukainen.
Svenska (Swedish)	Härmed intygar Zyxel att denna utrustning står i överensstämmelse med de väsentliga egenskapskrav och övriga relevanta bestämmelser som framgår av direktiv 2014/53/EU.
Български (Bulgarian)	С настоящото Zyxel декларира, че това оборудване е в съответствие със съществените изисквания и другите приложими разпоредбите на Директива 2014/53/ЕС.

Notes:

- Not all European states that implement EU Directive 2014/53/EU are European Union (EU) members.
- The regulatory limits for maximum output power are specified in EIRP. The EIRP level (in dBm) of a device can be calculated by adding the gain of the antenna used (specified in dBi) to the output power available at the connector (specified in dBm).

List of national codes

COUNTRY	ISO 3166 2 LETTER CODE	COUNTRY	ISO 3166 2 LETTER CODE
Austria	AT	Liechtenstein	LI
Belgium	BE	Lithuania	LT
Bulgaria	BG	Luxembourg	LU
Croatia	HR	Malta	MT
Cyprus	CY	Netherlands	NL
Czech Republic	CZ	Norway	NO
Denmark	DK	Poland	PL
Estonia	EE	Portugal	PT
Finland	FI	Romania	RO
France	FR	Serbia	RS
Germany	DE	Slovakia	SK
Greece	GR	Slovenia	SI
Hungary	HU	Spain	ES
Iceland	IS	Sweden	SE
Ireland	IE	Switzerland	CH
Italy	IT	Turkey	TR
Latvia	LV	United Kingdom	GB

Safety Warnings

- Do not put the device in a place that is humid, dusty, has extreme temperatures, or that blocks the device ventilation slots. These conditions may harm your device.
- Please refer to the device back label, datasheet, box specifications or catalog information for power rating of the device and operating temperature.
- There is a remote risk of electric shock from lightning: (1) Do not use the device outside, and make sure all the connections are indoors. (For indoor devices only) (2) Do not install or service this device during a thunderstorm.

- Do not expose your device to dampness, dust or corrosive liquids.
- Do not store things on the device.
- Do not obstruct the device ventilation slots as insufficient airflow may harm your device. For example, do not place the device in an enclosed space such as a box or on a very soft surface such as a bed or sofa.
- Connect ONLY suitable accessories to the device.
- Do not open the device. Opening or removing the device covers can expose you to dangerous high voltage points or other risks. ONLY qualified service personnel should service or disassemble this device. Please contact your vendor for further information.
- Make sure to connect the cables to the correct ports.
- Place connected cables carefully so that no one will step on them or stumble over them.
- Disconnect all cables from this device before servicing or disassembling.
- Do not remove the plug and connect it to a power outlet by itself; always attach the plug to the power adaptor first before connecting it to a power outlet.
- Do not allow anything to rest on the power adaptor or cord and do NOT place the product where anyone can walk on the power adaptor or cord.
- Please use the provided or designated connection cables/power cables/adaptors. Connect the power adaptor or cord to the right supply voltage (for example, 120V AC in North America or 230V AC in Europe). If the power adaptor or cord is damaged, it might cause electrocution. Remove the damaged power adaptor or cord from the device and the power source. Do not try to repair the power adaptor or cord by yourself. Contact your local vendor to order a new one.
- CAUTION: There is a risk of explosion if you replace the device battery with an incorrect one. Dispose of used batteries according to the instructions. Dispose them at the applicable collection point for the recycling of electrical and electronic devices. For detailed information about recycling of this product, please contact your local city office, your household waste disposal service or the store where you purchased the product.
- Do not leave a battery in an extremely high temperature environment or surroundings since it can result in an explosion or the leakage of flammable liquid or gas.
- Do not subject a battery to extremely low air pressure since it may result in an explosion or the leakage of flammable liquid or gas.
- The following warning statements apply, where the disconnect device is not incorporated in the device or where the plug on the power supply cord is intended to serve as the disconnect device,
 - For a permanently connected device, a readily accessible method to disconnect the device shall be incorporated externally to the device;
 - For a pluggable device, the socket-outlet shall be installed near the device and shall be easily accessible.
- This device must be grounded by qualified service personnel. Never defeat the ground conductor or operate the device in the absence of a suitably installed ground conductor. Contact the appropriate electrical inspection authority or an electrician if you are uncertain that suitable grounding is available. (For devices that require grounding)
 - If your device has an earthing screw (frame ground), connect the screw to a ground terminal using an appropriate AWG ground wire. Do this before you make other connections.
 - If your device has no earthing screw, but has a 3-prong power plug, make sure to connect the plug to a 3-hole earthed socket.
- Do not leave a battery in an extremely high temperature environment or surroundings since it can result in an explosion or the leakage of flammable liquid or gas. (For devices with a battery)
- Do not subject a battery to extremely low air pressure since it may result in an explosion or the leakage of flammable liquid or gas. (For devices with a battery)
- Fuse Warning! Replace a fuse only with a fuse of the same type and rating. (For devices with a fuse)

- To avoid possible eye injury, do not look into an operating fiber-optic module's connector. (For devices with fiber)
- Complies with 21 CFR 1040.10 and 1040.11 except for conformance with IEC 60825-1 Ed. 3., as described in Laser Notice No. 56, dated May 8, 2019. (For devices with fiber)
- Conforme à 21 CFR 1040.10 et 1040.11 sauf pour la conformité à la norme CEI 60825-1 Ed. 3., comme décrit dans la notice laser Numéro 56 du 8 mai 2019. (For devices with fiber)
- CLASS 1 LASER PRODUCT & "IEC 60825-1:2014" (For devices with fiber)
- APPAREIL À LASER DE CLASS 1 (For devices with fiber)
- CLASS 1 CONSUMER LASER PRODUCT & "EN 50689:2021" (For devices with fiber)

Environment statement

ErP (Energy-related Products)

Zyxel products put on the EU and United Kingdom markets comply with the requirement of the European Parliament and the Council published Directive 2009/125/EC and UK regulation establishing a framework for the setting of ecodesign requirements for energy-related products (recast), the so called "ErP Directive (Energy-related Products directive), as well as ecodesign requirements laid down in applicable implementation measures. Power consumption has satisfied the regulation requirements which are:

- Network standby power consumption < 8W (watts), and/or
- Off mode power consumption < 0.5W (watts), and/or
- Standby mode power consumption < 0.5W(watts).

Disposal and Recycling Information

The symbol below means that according to local regulations your product and/or its battery shall be disposed of separately from domestic waste. If this product is end of life, take it to a recycling station designated by local authorities. At the time of disposal, the separate collection of your product and/or its battery will help save natural resources and ensure that the environment is sustainable development.

Die folgende Symbol bedeutet, dass Ihr Produkt und/oder seine Batterie gemäß den örtlichen Bestimmungen getrennt vom Hausmüll entsorgt werden muss. Wenden Sie sich an eine Recyclingstation, wenn dieses Produkt das Ende seiner Lebensdauer erreicht hat. Zum Zeitpunkt der Entsorgung wird die getrennte Sammlung von Produkt und/oder seiner Batterie dazu beitragen, natürliche Ressourcen zu sparen und die Umwelt und die menschliche Gesundheit zu schützen.

El símbolo de abajo indica que según las regulaciones locales, su producto y/o su batería deberán depositarse como basura separada de la doméstica. Cuando este producto alcance el final de su vida útil, llévalo a un punto limpio. Cuando llegue el momento de desechar el producto, la recogida por separado éste y/o su batería ayudará a salvar los recursos naturales y a proteger la salud humana y medioambiental.

Le symbole ci-dessous signifie que selon les réglementations locales votre produit et/ou sa batterie doivent être éliminés séparément des ordures ménagères. Lorsque ce produit atteint sa fin de vie, amenez-le à un centre de recyclage. Au moment de la mise au rebut, la collecte séparée de votre produit

et/ou de sa batterie aidera à économiser les ressources naturelles et protéger l'environnement et la santé humaine.

Il simbolo sotto significa che secondo i regolamenti locali il vostro prodotto e/o batteria deve essere smaltito separatamente dai rifiuti domestici. Quando questo prodotto raggiunge la fine della vita di servizio portarlo a una stazione di riciclaggio. Al momento dello smaltimento, la raccolta separata del vostro prodotto e/o della sua batteria aiuta a risparmiare risorse naturali e a proteggere l'ambiente e la salute umana.

Symbolen innebär att enligt lokal lagstiftning ska produkten och/eller dess batteri kastas separat från hushållsavfallet. När den här produkten når slutet av sin livslängd ska du ta den till en återvinningsstation. Vid tiden för kasseringen bidrar du till en bättre miljö och mänsklig hälsa genom att göra dig av med den på ett återvinningsställe.



台灣



以下訊息僅適用於產品銷售至台灣地區

- 取得審驗證明之低功率射頻器材，非經核准，公司、商號或使用者均不得擅自變更頻率、加大功率或變更原設計之特性及功能。
- 低功率射頻器材之使用不得影響飛航安全及干擾合法通信；經發現有干擾現象時，應立即停用，並改善至無干擾時方得繼續使用。前述合法通信，指依電信管理法規定作業之無線電通信。低功率射頻器材須忍受合法通信或工業、科學及醫療用電波輻射性電機設備之干擾。
- 使用無線產品時，應避免影響附近雷達系統之操作。
- 高增益指向性天線只得應用於固定式點對點系統。

以下訊息僅適用於產品屬於專業安裝並銷售至台灣地區

- 本器材須經專業工程人員安裝及設定，始得設置使用，且不得直接販售給一般消費者。

以下訊息僅適用於產品屬於行動通信電信終端設備並銷售至台灣地區

- 減少電磁波影響，請妥適使用。

- (Model name)
電波功率密度 MPE 標準值 :XX mW/ cm²，送測產品實測值 :XX mW/ cm²，建議使用時設備天線至少距離人體 XX 公分。
- (Model name)
電波功率密度 MPE 標準值 :XX mW/ cm²，送測產品實測值 :XX mW/ cm²，建議使用時設備天線至少距離人體 XX 公分。





安全警告 - 為了您的安全，請先閱讀以下警告及指示：

- 請勿將此產品接近水、火焰或放置在高溫的環境。
避免設備接觸
 - 任何液體 - 切勿讓設備接觸水、雨水、高濕度、污水腐蝕性的液體或其他水份。
 - 灰塵及污物 - 切勿接觸灰塵、污物、沙土、食物或其他不合適的材料。
- 雷雨天氣時，不要安裝或維修此設備。有遭受電擊的風險。
- 切勿重摔或撞擊設備，並勿使用不正確的電源變壓器。
- 若接上不正確的電源變壓器會有爆炸的風險。
- 請勿隨意更換產品內的電池。
- 如果更換不正確之電池型式，會有爆炸的風險，請依製造商說明書處理使用過之電池。
- 請將廢電池丟棄在適當的電器或電子設備回收處。
- 請勿將設備解體。
- 請勿阻礙設備的散熱孔，空氣對流不足將會造成設備損害。
- 請使用隨貨提供或指定的連接線 / 電源線 / 電源變壓器，將其連接到合適的供應電壓 (如：台灣供應電壓 110 伏特) 。
- 假若電源變壓器或電源變壓器的纜線損壞，請從插座拔除，若您還繼續插電使用，會有觸電死亡的風險。
- 請勿試圖修理電源變壓器或電源變壓器的纜線，若有毀損，請直接聯絡您購買的店家，購買一個新的電源變壓器。
- 請勿將此設備安裝於室外，此設備僅適合放置於室內。(僅限於室內產品)
- 請勿隨一般垃圾丟棄。
- 請參閱產品背貼上的設備額定功率。
- 請參考產品型錄或是彩盒上的作業溫度。
- 產品沒有斷電裝置或者採用電源線的插頭視為斷電裝置的一部分，以下警語將適用：
 - 對永久連接之設備，在設備外部須安裝可觸及之斷電裝置；
 - 對插接式之設備，插座必須接近安裝之地點而且是易於觸及的。

About the Symbols

Various symbols are used in this product to ensure correct usage, to prevent danger to the user and others, and to prevent property damage. The meaning of these symbols are described below. It is important that you read these descriptions thoroughly and fully understand the contents.

Explanation of the Symbols

SYMBOL	EXPLANATION
	Alternating current (AC): AC is an electric current in which the flow of electric charge periodically reverses direction.
	Direct current (DC): DC is the unidirectional flow or movement of electric charge carriers.
	Earth; ground: A wiring terminal intended for connection of a Functional Earthing Conductor.
	Class II equipment: The method of protection against electric shock in the case of class II equipment is either double insulation or reinforced insulation.

Viewing Certifications

Go to <http://www.zyxel.com> to view this product's documentation and certifications.

Zyxel Limited Warranty

Zyxel warrants to the original end user (purchaser) that this product is free from any defects in material or workmanship for a specific period (the Warranty Period) from the date of purchase. The Warranty Period varies by region. Check with your vendor and/or the authorized Zyxel local distributor for details about the Warranty Period of this product. During the warranty period, and upon proof of purchase, should the product have indications of failure due to faulty workmanship and/or materials, Zyxel will, at its discretion, repair or replace the defective products or components without charge for either parts or labor, and to whatever extent it shall deem necessary to restore the product or components to proper operating condition. Any replacement will consist of a new or re-manufactured functionally equivalent product of equal or higher value, and will be solely at the discretion of Zyxel. This warranty shall not apply if the product has been modified, misused, tampered with, damaged by an act of God, or subjected to abnormal working conditions.

Note

Repair or replacement, as provided under this warranty, is the exclusive remedy of the purchaser. This warranty is in lieu of all other warranties, express or implied, including any implied warranty of merchantability or fitness for a particular use or purpose. Zyxel shall in no event be held liable for indirect or consequential damages of any kind to the purchaser.

To obtain the services of this warranty, contact your vendor. You may also refer to the warranty policy for the region in which you bought the device at <https://www.zyxel.com/global/en/support/warranty-information>.

Open Source Licenses

This product may contain in part some free software distributed under GPL license terms and/or GPL-like licenses.

To request the source code covered under these licenses, please go to: https://www.zyxel.com/form/gpl_oss_software_notice.shtml.

Numbers

802.11k [13, 14, 15, 16](#)

802.11r [13, 14, 15, 16](#)

802.11v [13, 14, 15, 16](#)

A

access [56](#)

access privileges [21](#)

access users [169](#)
 see also users [169](#)

admin users [169](#)
 multiple logins [174](#)
 see also users [169](#)

alerts [259, 260, 261](#)

AP Controller [13, 14, 15, 16](#)

applications
 MBSSID [21](#)
 Repeater [87](#)

Assisted Roaming, see 802.11k/v

B

backing up configuration files [265](#)

Basic Service Set
 see BSS

BSS [21](#)

C

CA
 and certificates [223](#)

CA (Certificate Authority), see certificates

CEF (Common Event Format) [257, 258](#)

Certificate Authority (CA)

see certificates

Certificate Revocation List (CRL) [223](#)
 vs OCSP [237](#)

certificates [222](#)
 advantages of [223](#)
 and CA [223](#)
 and FTP [255](#)
 and HTTPS [244](#)
 and SSH [253](#)
 and WWW [245](#)
 certification path [223, 230, 235](#)
 expired [223](#)
 factory-default [223](#)
 file formats [223](#)
 fingerprints [231, 236](#)
 importing [226](#)
 not used for encryption [223](#)
 revoked [223](#)
 self-signed [223, 227](#)
 serial number [230, 235](#)
 storage space [225, 233](#)
 thumbprint algorithms [224](#)
 thumbprints [224](#)
 used for authentication [223](#)
 verifying fingerprints [224](#)

certification requests [227](#)

certifications
 viewing [382](#)

channel [22](#)

CLI [33, 58](#)
 button [58](#)
 messages [58](#)
 popup window [58](#)
 Reference Guide [1](#)

cold start [66](#)

commands [33](#)
 sent by Web Configurator [58](#)

Common Event Format (CEF) [257, 258](#)

configuration
 information [276, 296](#)

configuration files [262](#)
 at restart [265](#)

- backing up [265](#)
- downloading [266](#)
- downloading with FTP [255](#)
- editing [262](#)
- how applied [263](#)
- lastgood.conf [265](#), [267](#)
- managing [265](#)
- startup-config.conf [267](#)
- startup-config-bad.conf [265](#)
- syntax [262](#)
- system-default.conf [267](#)
- uploading [268](#)
- uploading with FTP [255](#)
- use without restart [262](#)
- contact information [364](#)
- cookies [54](#)
- copyright [369](#)
- CPU usage [69](#), [71](#)
- current date/time [70](#), [240](#)
 - daylight savings [241](#)
 - setting manually [242](#)
 - time server [242](#)
- customer support [364](#)

D

- date [240](#)
- daylight savings [241](#)
- DCS [155](#)
- DHCP [239](#)
 - and domain name [239](#)
- diagnostics [276](#), [296](#)
- disclaimer [369](#)
- domain name [239](#)
- dual-radio application [22](#)
- dynamic channel selection [155](#)

E

- encryption [87](#)
- ESSID [311](#)
- Extended Service Set IDentification [176](#)

F

- Fast Roaming, see [802.11r](#)
- file extensions
 - configuration files [262](#)
 - shell scripts [262](#)
- file manager [262](#)
- Firefox [54](#)
- firmware
 - current version [69](#), [270](#), [292](#)
 - uploading [269](#), [270](#), [292](#)
 - uploading with FTP [255](#)
- flash usage [69](#)
- FTP [34](#), [255](#)
 - and certificates [255](#)
 - with Transport Layer Security (TLS) [255](#)

G

- Guide
 - CLI Reference [1](#)

H

- HTTP
 - over SSL, see [HTTPS](#)
 - redirect to [HTTPS](#) [245](#)
 - vs [HTTPS](#) [244](#)
- [HTTPS](#) [244](#)
 - and certificates [244](#)
 - authenticating clients [244](#)
 - avoiding warning messages [247](#)
 - example [246](#)
 - vs HTTP [244](#)
 - with Internet Explorer [246](#)
 - with Netscape Navigator [246](#)
- HyperText Transfer Protocol over Secure Socket Layer, see [HTTPS](#)

I

- interface
 - status [70](#)

interfaces
 as DHCP servers [239](#)

interference [22](#)

Internet Explorer [54](#)

Internet Protocol version 6, see IPv6

IP Address [148](#)
 gateway IP address [148](#)

IP subnet [148](#)

IPv6 [355](#)
 addressing [355](#)
 EUI-64 [357](#)
 global address [356](#)
 interface ID [357](#)
 link-local address [355](#)
 Neighbor Discovery Protocol [355](#)
 ping [355](#)
 prefix [355](#)
 prefix length [355](#)
 stateless autoconfiguration [357](#)
 unspecified address [356](#)

J

Java
 permissions [54](#)

JavaScripts [54](#)

K

key pairs [222](#)

L

lastgood.conf [265, 267](#)

layer-2 isolation [217](#)
 example [217](#)
 MAC [218](#)

LED suppression [278](#)

LEDs [35](#)

Locator LED [279](#)

log messages
 categories [259, 260, 261](#)

debugging [145](#)
 regular [145](#)
 types of [145](#)

logout
 Web Configurator [58](#)

logs
 formats [257](#)
 settings [256](#)

M

MAC address
 range [69](#)

management mode [25](#)

Management, NCC [26](#)

Management, Standalone [25](#)

managing the device
 good habits [34](#)
 using FTP, see FTP

MBSSID [21](#)

memory usage [69, 72](#)

messages
 CLI [58](#)

mode, default [25](#)

model name [69](#)

My Certificates, see also certificates [225](#)

N

NAT mode [177](#)

NCC, see Nebula Control Center

Nebula Control Center [26](#)

Netscape Navigator [54](#)

Network Time Protocol (NTP) [242](#)

O

objects
 certificates [222](#)
 users, account
 user [169](#)

Online Certificate Status Protocol (OCSP) [237](#)

vs CRL [237](#)
 overview [66, 87, 284](#)

P

passkey
 overview [314](#)
 pop-up windows [54](#)
 power off [67](#)
 power on [66](#)
 Public-Key Infrastructure (PKI) [223](#)
 public-private key pairs [222](#)

R

radio [22](#)
 reboot [66, 281](#)
 vs reset [281, 299](#)
 Reference Guide, CLI [1](#)
 remote management
 FTP, see FTP
 WWW, see WWW
 reset [312](#)
 vs reboot [281, 299](#)
 RESET button [67, 312](#)
 restart [281](#)
 RF interference [22](#)
 Rivest, Shamir and Adleman public-key algorithm
 (RSA) [227](#)
 RSA [227, 236](#)
 RSSI threshold [190](#)

S

screen resolution [54](#)
 Secure Socket Layer, see SSL
 Sensitive Data Protection [264](#)
 serial number [69](#)
 service control
 and users [243](#)
 limitations [243](#)

timeouts [243](#)
 Service Set [176](#)
 Service Set Identifier
 see SSID
 shell scripts [262](#)
 downloading [274, 295](#)
 editing [273, 293](#)
 how applied [263](#)
 managing [273, 293](#)
 syntax [262](#)
 uploading [274, 295](#)
 SSH [251](#)
 and certificates [253](#)
 client requirements [253](#)
 encryption methods [252](#)
 for secure Telnet [253](#)
 how connection is established [251](#)
 versions [252](#)
 with Linux [254](#)
 with Microsoft Windows [253](#)

SSID [21](#)
 SSID profile
 pre-configured [21](#)
 SSID profiles [21](#)
 SSL [244](#)
 starting the device [66](#)
 startup-config.conf [267](#)
 if errors [265](#)
 missing at restart [265](#)
 present at restart [265](#)
 startup-config-bad.conf [265](#)
 station [155](#)
 stopping the device [66](#)
 supported browsers [54](#)
 syslog [257, 258](#)
 system name [69, 239](#)
 system uptime [70](#)
 system-default.conf [267](#)

T

Telnet
 with SSH [253](#)
 time [240](#)
 time servers (default) [242](#)

trademarks [369](#)
Transport Layer Security (TLS) [255](#)
troubleshooting [276, 296](#)
Trusted Certificates, see also certificates [232](#)

U

upgrading
 firmware [269](#)
uploading
 configuration files [268](#)
 firmware [269](#)
 shell scripts [273, 293](#)
usage
 CPU [69, 71](#)
 flash [69](#)
 memory [69, 72](#)
 onboard flash [69](#)
user authentication [169](#)
user name
 rules [170](#)
user objects [169](#)
users [169](#)
 access, see also access users
 admin (type) [169](#)
 admin, see also admin users
 and service control [243](#)
 currently logged in [70](#)
 default lease time [173, 175](#)
 default reauthentication time [174, 175](#)
 lease time [172](#)
 limited-admin (type) [169](#)
 lockout [174](#)
 reauthentication time [172](#)
 types of [169](#)
 user (type) [169](#)
 user names [170](#)

V

Vantage Report (VRPT) [257, 258](#)
Virtual Local Area Network [151](#)
VLAN [151](#)
 introduction [151](#)

VRPT (Vantage Report) [257, 258](#)

W

warm start [66](#)
warranty
 note [382](#)
WDS [87](#)
Web Configurator [33, 54](#)
 access [56](#)
 requirements [54](#)
 supported browsers [54](#)
WEP (Wired Equivalent Privacy) [177](#)
wireless channel [311](#)
wireless client [155](#)
Wireless Distribution System (WDS) [87](#)
wireless LAN [311](#)
wireless network
 example [154](#)
wireless profile [176](#)
 layer-2 isolation [176](#)
 MAC filtering [176](#)
 radio [176](#)
 security [176](#)
 SSID [176](#)
wireless security [21, 311](#)
wireless station [155](#)
Wizard Setup [74](#)
WLAN interface [22](#)
WPA2 [178](#)
WWW [244](#)
 and certificates [245](#)
 see also HTTP, HTTPS [244](#)

Z

ZDP [28](#)
ZON Utility [28](#)